**R32****R410A**

AUXB004HLAH
AUXB005HLAH
AUXB007HLAH
AUXB009HLAH
AUXB012HLAH
AUXB014HLAH
AUXB018HLAH

R32

AUXN009HLAH
AUXN012HLAH
AUXN014HLAH



Refer to the rating label for the serial number,
manufactured year and month.

FUJITSU GENERAL LIMITED

OPERATION MANUAL

VRF system indoor unit (Cassette type)

Keep this manual for future reference.

English

BEDIENUNGSANLEITUNG

VRF-System Innengerät (Kassettyp)

Bewahren Sie dieses Handbuch für eine spätere Bezugnahme auf.

Deutsch

MODE D'EMPLOI

Unité intérieure à système VRF (Type cassette)

Conservez ce manuel pour toute référence ultérieure.

Français

MANUAL DE FUNCIONAMIENTO

Unidad interior del sistema VRF (Tipo casete)

Conserve este manual para posibles consultas futuras.

Español

MANUALE DI ISTRUZIONI

Unità interna del sistema VRF (tipo a cassetta)

Conservare questo manuale per consultazione futura.

Italiano

ΕΓΧΕΙΡΙΔΙΟ ΛΕΙΤΟΥΡΓΙΑΣ

Εσωτερική μονάδα συστήματος VRF (Τύπος κασέτας)

Διατηρήστε το παρόν εγχειρίδιο για μελλοντική αναφορά.

Ελληνικά

MANUAL DE FUNCIONAMENTO

Unidade interior do sistema VRF (Tipo casete)

Guarde este manual para consulta futura.

Português

KULLANIM KILAVUZU

VRF sistemi iç ünitesi (Kaset tipi)

Bu kılavuzu ileride başvurmak üzere saklayın.

Türkçe

MADE IN P.R.C.



PART No. 9369313394-01

CONTENTS

SAFETY PRECAUTIONS..... 1
 NAME OF PARTS 2
 MANUAL AUTO OPERATION 2
 ADJUSTING THE DIRECTION OF AIR CIRCULATION..... 3
 OPERATING TIPS 3
 CLEANING AND CARE..... 3
 TROUBLESHOOTING 4
 SPECIFICATIONS..... 5



SAFETY PRECAUTIONS

To prevent personal injury or property damage, read this section carefully before you use this product, and be sure to comply with the following safety precautions.





Incorrect operation due to failure to follow the instructions may cause harm or damage, the seriousness of which is classified as follows:

 **WARNING**
 This mark warns of death or serious injury.

 **CAUTION**
 This mark warns of injury or damage to property.

-  This mark denotes an action that is PROHIBITED.
-  This mark denotes an action that is COMPULSORY.

Explanation of symbols displayed on the indoor unit or outdoor unit.

	WARNING This symbol shows that this product uses a low burning velocity material. If the refrigerant is leaked and exposed to an external ignition source, there is a risk of fire.
	CAUTION This symbol shows that the operation manual should be read carefully.
	CAUTION This symbol shows that a service personnel should be handling this equipment with reference to the installation manual.
	CAUTION This symbol shows that information is available such as the operation manual or installation manual.

 **WARNING**

-  The appliance shall be installed, operated and stored in a room with a floor area larger than X m².

Amount of refrigerant charge M (kg)	Minimum room area (m ²)	
	Installation height H (m)	
	1.8 ≤ H < 2.2	2.2 ≤ H
M ≤ 1.842	—	—
1.842 < M ≤ 3.40	10.93	7.32
3.40 < M ≤ 3.50	11.58	7.75
3.50 < M ≤ 4.00	15.13	10.13
4.00 < M ≤ 4.50	19.15	12.82
4.50 < M ≤ 5.00	23.64	15.83
5.00 < M ≤ 5.50	28.61	19.15
5.50 < M ≤ 6.00	34.04	22.79

(IEC 60335-2-40)

- This product contains no user-serviceable parts. Always consult authorized service personnel for repairing, installation, and relocation of this product. Improper installation or handling will cause leakage, electric shock, or fire.
- In the event of a malfunction such as burning smell, immediately stop operation of the air conditioner, and disconnect all the power supply by turning off the electrical breaker or disconnecting the power plug. Then consult authorized service personnel.
- Take care not to damage the power supply cable. If it is damaged, it should be replaced only by the authorized service personnel in order to avoid a hazard.
- In the event of refrigerant leakage, be sure to keep away from fire or any flammables, and consult authorized service personnel.
- In the event of a thunder storm or any prior sign of a lightning strike, turn off the air conditioner via the remote controller, and refrain from touching the product or the power source to prevent any electrical hazards.
- This product shall be stored in a room without continuously operating ignition sources (for example: open flames, an operating gas appliance or an operating electric heater).
- This product shall be stored in a well-ventilated area.
- Be aware that refrigerants may not contain an odour.
- This product shall be stored so as to prevent mechanical damage from occurring.
- Disposing of the product shall be done properly, in compliance with national or regional regulations.
- During transportation or relocation of the indoor unit, pipes shall be covered with the wall hook bracket for protection. Do not move this product by holding the indoor unit pipes. (The stress applied to the pipe joints may cause the flammable gas to leak during operation).
- This product is not intended for use by persons (including children) with reduced physical, sensory or mental capabilities, or lack of experience and knowledge, unless they have been given supervision or instruction concerning use of this product by a person responsible for their safety. Children should be supervised to ensure that they do not play with this product.

⚠ WARNING

- Do not install the unit in area filled with mineral oil such as a factory or area containing a large amount of splashed oil or steam such as a kitchen.
- Do not start or stop the operation of this product by turning on or off the circuit breaker.
- Do not use flammable gases near this product.
- Do not expose yourself directly to the cooling airflow for many hours.
- Do not insert your fingers or any other objects into outlet port or inlet grille.
- Do not operate with wet hands.
- Do not use means to accelerate the defrosting process or to clean this product, other than those recommended by the manufacturer.
- Do not pierce or burn.

⚠ CAUTION

- Provide occasional ventilation during use.
 - Always operate this product with air filters installed.
 - Ensure that any electronic equipment is at least 1 m (40 in) away from this product.
 - Disconnect all the power supply when not using this product for extended periods.
 - After a long period of use, ensure to get the mounting of the indoor unit checked to prevent this product from falling down.
 - The airflow direction and the room temperature should be carefully considered when you use this product in a room with infants, children, elderly or sick persons.
 - Keep the surroundings of the outdoor unit clean and tidy, and do not place items around it. Any objects blocking or entering from the outlet ports may cause product malfunction.
- Do not direct the airflow at fireplaces or heating apparatus.
 - Do not block or cover the intake grille and the outlet port.
 - Do not apply any heavy pressure to radiator fins.
 - Do not climb on, place objects on, or hang objects from this product.
 - Do not place any other electrical products or household belongings under this product. Dripping condensation from this product might get them wet, and may cause damage or malfunction of your property.
 - Do not expose this product directly to water.
 - Do not use this product for preservation of food, plants, animals, precision equipment, art work, or other objects. This may cause quality deterioration of those items.
 - Do not expose animals or plants to the direct airflow.
 - Do not drink the drainage from the air conditioner.
 - Do not pull the power supply cable.
 - Do not touch the aluminum fins of heat exchanger built-in this product to avoid personal injury when you install or maintain the unit.
 - Do not stand on unstable steps when operating or cleaning this product. It may overturn and can cause injury.

NAME OF PARTS

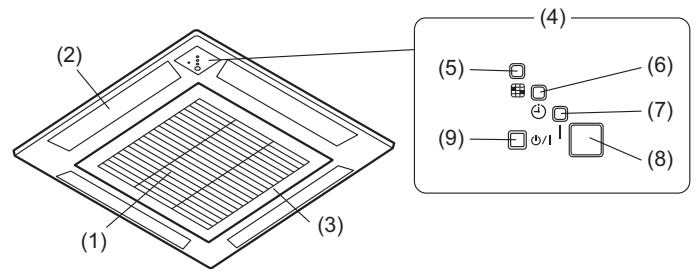

- (1) Air Filter
- (2) Airflow Direction Flaps
- (3) Air Intake Grille
- (4) Operating Control Panel and Indicator Lamps
- (5) FILTER Indicator Lamp (Red): Lights on when it is time to clean the filter. Clean the filter according to "CLEANING AND CARE". Lights off when the RESET button is pressed after cleaning.
- (6) TIMER Indicator Lamp (Orange): It lights on while timer is working.
- (7) OPERATION Indicator Lamp (Green): It lights on while operating.
- (8) Remote Control Signal Receiver: This is the place to receive the signals from the remote controller.
- (9) MANUAL AUTO button: This is used to operate it while remote controller is not available.

Control unit (optional)

Types of remote controllers:

- Wireless remote controller
- Wired remote controller
- Simple remote controller

For operation method, refer to the Operation Manual of each device.

MANUAL AUTO OPERATION

Use the MANUAL AUTO operation in the event the remote control unit is lost or otherwise unavailable.

⚠ CAUTION

Do not press the MANUAL AUTO button with wet hands or pointed objects, otherwise an electric shock or malfunction may occur.

Starting Operation

Press the MANUAL AUTO button on the operating control panel.

The operation can be set in the following setting.

Operating mode	AUTO: When Auto mode cannot be selected, it will operate in the same mode as the other indoor unit in the same system. (When other indoor unit in the same system doesn't operate, the air conditioner will operate in cooling.)
Fan speed	AUTO
Setting temperature	23 °C

Stopping Operation

Press the MANUAL AUTO button on the operating control panel.

ADJUSTING THE DIRECTION OF AIR CIRCULATION

The vertical wind direction can be controlled with the control unit.

Vertical direction

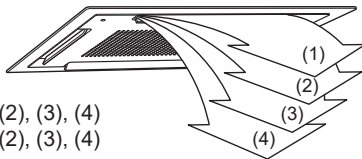

Cooling & Dry : (1), (2), (3), (4)
 Heating : (1), (2), (3), (4)

OPERATING TIPS

Operation and Performance

About priority state and standby state

- Multiple indoor units can be connected within the same system. Depending on the system, choice of operating mode are limited.

Cooling priority state:

When the other indoor units within the same system operate in cooling or dry mode, heating cannot be selected at the same time.

Heating priority state:

When the other indoor units within the same system operate in heating mode, cooling and dry mode cannot be selected at the same time.

Standby state:

The standby state activates when 2 or more indoor units start up at the same time in different mode. Any indoor unit other than priority mode will wait in standby state until priority mode changes (operation starts as soon as priority is switched).

At this time, the OPERATION indicator lamp (green) lights up and the TIMER indicator lamp (orange) flashes.

Low ambient cooling

- When the outdoor temperature drops, the outdoor unit's fans may switch to Low Speed, or one of the fans may stop intermittently.

Heating performance

- Heating mode operates on the heat-pump principle, absorbing heat from outdoor air and transferring that heat indoors. As a result, the operating performance is reduced as outdoor air temperature drops. If you feel that insufficient heating performance is being produced, we recommend you use this air conditioner in conjunction with another type of heating appliance.
- Heating mode heat your entire room by recirculating air throughout the room, with the result that some time may be required after first starting the air conditioner until the room is heated.

Microcomputer-controlled automatic defrosting

- When using the Heating mode under conditions of low outdoor air temperature high humidity, frost may form on the outdoor unit, resulting in reduced operating performance. In order to prevent this kind of reduced performance, this unit is equipped with a Microcomputer-controlled automatic defrosting function. If frost forms, the air conditioner will temporarily stop, and the defrosting circuit will operate briefly (for about 4 to 15 minutes).

During Automatic Defrosting operation, the OPERATION indicator lamp (green) will flash.

Oil recovery operation

- Periodically, the oil recovery operation is performed in order to return compressor oil to the outdoor unit. During oil recovery operation, the OPERATION indicator lamp (green) will flash (for about 10 minutes).

Operable conditions of temperature and humidity

- The temperature and humidity required for operating this product is as shown in the following table.

	Cooling/Dry Mode	Heating Mode
Outdoor temperature	Refer to the specification of outdoor units.	
Indoor temperature	18 to 32 °C DB	10 to 30 °C DB
Indoor humidity	About 80% or less	

- If the air conditioner is operated under higher temperature conditions than those listed, the built-in protection circuit may operate to prevent internal circuit damage. Also, during Cooling and Dry modes, if the unit is used under conditions of lower temperature than those listed above, the heat-exchanger may freeze, leading to water leakage and other damage.
- If the unit is used for long periods under high-humidity conditions, condensation may form on the surface of the indoor unit, and drip onto the floor or other objects underneath.
- Do not use this unit for any purposes other than the Cooling, Heating, Dehumidifying, and air-circulation of rooms in ordinary dwellings.

CLEANING AND CARE

CAUTION

- Before cleaning the unit, be sure to stop the unit and disconnect the power supply.
- Do not stand on an unstable platform when cleaning.
- When removing and replacing the air filter, be sure not to touch the heat exchanger, as personal injury may result.
- Be sure the intake grille is installed securely.
- Do not clean the inside of the unit by yourself. To clean the inside, always consult authorized service personnel.
- When cleaning the unit's body, do not use water hotter than 40 °C, harsh abrasive cleansers, or volatile agents like benzene or thinner.
- Do not remove any part from the unit except for the filter.
- If dirt is allowed to accumulate on the Air Filter, airflow will be reduced, lowering operating efficiency and increasing noise.
- During periods of normal use, the air filter should be cleaned every 2 months.

Cleaning the Air Filter

When the filter lamp lights on, remove and clean the filter.

1. Push the intake grille's hooks inward towards the center of the unit to open the intake grille.

2. Pull out the filter from the intake grille.

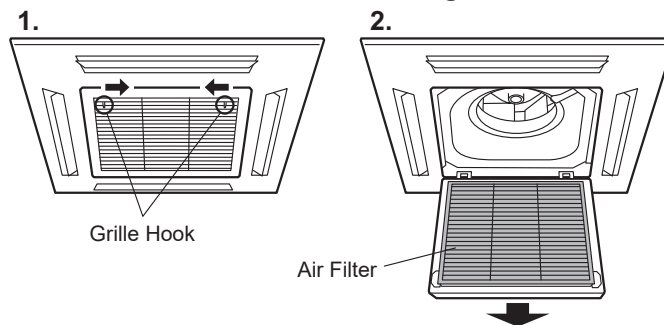

3. Clean the air filter.

Remove the dust from the air filter by vacuuming or washing them. After washing, allow the air filter to dry thoroughly in an area protected from sunlight.

4. Re-attach the air filter to the intake grille.

- (1) Replace the air filter into its holder.
- (2) Make sure that the air filter makes contact with the filter stopper when it is replaced into its holder.

5. Close the intake grille and push the intake grille's hooks outward.

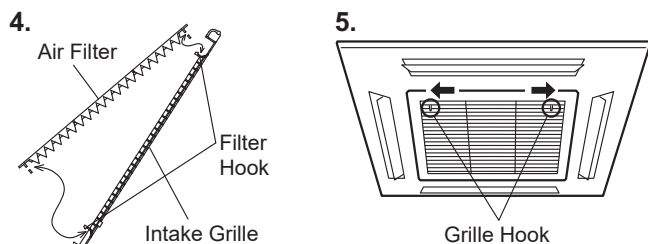

- Dust can be cleaned from the air filter either with a vacuum cleaner, or by washing the filter in a solution of mild detergent and warm water. If you wash the filter, be sure to allow it to dry thoroughly in a shady place before reinstalling.
- If dirt is allowed to accumulate on the air filter, airflow will be reduced, lowering operating efficiency and increasing noise.
- After turning the power on, press the filter button on the remote control to turn off the filter lamp. (Refer to the operation manual packed with remote control unit for details.)

Cleaning the body

Wash the body with warm water, and then dry with a clean and soft cloth.

When not using for an extended period

Leave the breaker on for at least 12 hours before starting operation when it is to be used again.

TROUBLESHOOTING

The following conditions are not breakdowns or operation failures.

Doesn't operate immediately:

- If the unit is stopped and then immediately started again, the compressor will not operate for about 3 minutes, in order to prevent fuse blowouts.
- Whenever the electrical breaker is turned off then on again, the protection circuit will operate for about 3 minutes, preventing unit operation during that period.

Airflow is weak or stops:

- When Heating operation is started, indoor unit's fan may temporarily stop, to allow internal parts to warm up.
- During Heating operation, if the room temperature rises above the thermostat setting, the outdoor unit will stop, and the indoor unit's fan will stop. If you wish to warm the room further, set the thermostat for a higher setting.
- During oil recovery operation, the airflow may stop for approximately 10 minutes. (See page 2)
- During Heating operation, the unit will temporarily stop operation (between 4 and 15 minutes) as the Automatic Defrosting mode operates. (See page 2)
- The fan may operate at low speed during Dry operation or when the unit is monitoring the room's temperature.
- In the monitor AUTO operation, the fan will operate at low speed.

Flashing lamps:

- The OPERATION indicator lamp (green) flashes:
An oil recovery operation is being performed. (See page 2)
- The OPERATION indicator lamp (green) flashes:
An automatic defrosting operation is being performed. (See page 2)
- The OPERATION indicator lamp (green) and TIMER indicator lamp (orange) are flashing alternately:
It has recovered from a power outage.
- The OPERATION indicator lamp (green) and TIMER indicator lamp (orange) are flashing simultaneously:
It is operating in trial operation mode. Ask a manager as there may be maintenance being conducted.

- The OPERATION indicator lamp (green) lights up and the TIMER indicator lamp (orange) flashes:
This is the standby state. (See page 2)

Noise is heard:

- In the following conditions there are sounds of water flowing from the indoor unit and the operation sound becomes loud. These are the sounds of the flowing of refrigerant.
When operation starts
When oil recovery operation finishes
When automatic defrosting operation finishes
- During operation, a slight squeaking sound may be heard. This is the result of minute expansion and contraction of the panel due to temperature changes.
- During Heating operation, a sizzling sound may be heard occasionally. This sound is produced by the Automatic Defrosting operation. (See page 2)

Smells:

- Some smell may be emitted from the indoor unit. This smell is the result of room smells (furniture, tobacco, etc.) which have been taken into the air conditioner.

Fog comes out of the indoor unit:

- During Cooling operation, a thin mist may be seen emitted from the indoor unit. This results from the sudden Cooling of room air by the air emitted from the air conditioner, resulting in condensation and misting.

Steam comes out of the indoor unit:

- During Heating operation, the outdoor unit's fan may stop, and steam may be seen rising from the unit. This is due to the Automatic Defrosting operation. (See page 2)

Water is produced from the outdoor unit:

- During Heating operation, water may be produced from the outdoor unit due to the Automatic Defrosting operation.

The following conditions may not be breakdowns so check again.

Doesn't operate at all:

- Has there been a power failure?
- Has a fuse blown out, or a circuit breaker been tripped?
- Is the main power switch set to the OFF position?
- Are you trying to engage in an operation different from the priority state? (See page 2)
- Is it in standby state? (See page 2)

The operation mode cannot be changed:

- Are you trying to change to an operation different from the priority conditions? (See page 2)

Poor Cooling (or Heating) performance:

- Did you adjust the room temperature settings (thermostat) correctly?
- Is the air filter dirty? (See page 2)
- Are the air conditioner's inlet port or outlet port blocked?
- Is there a window or door open?
- In the case of Cooling operation, is a window allowing bright sunlight to enter? (Close the curtains.)
- In the case of Cooling operation, are there heating apparatus and computers inside the room, or are there too many people in the room?
- Is the fan speed set to low?

Set the temperature lower than the room temperature and use it:

- Temperature does not fall down well. Temperature may not fall down depending on the room conditions. (While high humidity or the room temperature is high.) (See page 2)

In the following situations stop operation immediately and get in touch with authorized service personnel.

- The problem cannot be solved even when the troubleshooting checks have been performed.
- The FILTER indicator lamp (red) is flashing very fast.
- The wired remote controller or simple remote controller indicate Er (when connected).
- It has burning smell.

SPECIFICATIONS

MODEL	AUXB 004 HLAH	AUXB 005 HLAH	AUXB 007 HLAH	AUXB 009 HLAH	AUXB 012 HLAH	AUXB 014 HLAH	AUXB 018 HLAH	
POWER SOURCE	220 - 240 V ~ 50 Hz							
AVAILABLE VOLT-AGE RANGE	198 to 264 V							
COOLING CAPACITY	[kW]	1.1	1.7	2.2	2.8	3.6	4.5	5.6
	[BTU/h]	3,800	5,800	7,500	9,600	12,300	15,400	19,100
HEATING CAPACITY	[kW]	1.3	1.9	2.8	3.2	4.1	5.0	6.3
	[BTU/h]	4,400	6,500	9,600	10,900	14,000	17,100	21,500
INPUT POWER	[W]	21	21	23	24	27	33	50
CURRENT	[A]	0.16	0.16	0.18	0.19	0.21	0.27	0.41
SOUND PRESSURE LEVEL (COOLING/HEATING)								
HIGH	dB [A]	34/34	34/34	34/34	35/35	37/37	39/39	45/45
MED - HIGH	dB [A]	32/31	32/31	32/32	33/33	34/34	37/37	39/39
MED	dB [A]	30/29	30/29	30/30	31/31	33/33	34/34	36/36
MED - LOW	dB [A]	28/26	28/26	28/28	29/29	31/31	32/32	33/33
LOW	dB [A]	27/24	27/24	27/27	27/27	29/29	30/30	30/30
QUIET	dB [A]	25/21	25/21	25/25	25/25	27/27	27/27	27/27
DIMENSIONS & WEIGHT								
HEIGHT	[mm]	245						
WIDTH	[mm]	570						
DEPTH	[mm]	570						
WEIGHT	[kg]	14.5	15	15.5	17			

MODEL	AUXN009HLAH	AUXN012HLAH	AUXN014HLAH	
POWER SOURCE	220 - 240 V ~ 50 Hz			
AVAILABLE VOLT-AGE RANGE	198 to 264 V			
COOLING CAPACITY	[kW]	2.8	3.6	4.5
	[BTU/h]	9,600	12,300	15,400
HEATING CAPACITY	[kW]	3.2	4.1	5.0
	[BTU/h]	10,900	14,000	17,100
INPUT POWER	[W]	41	71	81
CURRENT	[A]	0.33	0.57	0.62
SOUND PRESSURE LEVEL (COOLING/HEATING)				
HIGH	dB [A]	42/42	49/49	50/50
MED - HIGH	dB [A]	35/35	37/37	39/39
MED	dB [A]	31/31	33/33	34/34
MED - LOW	dB [A]	29/29	31/31	32/32
LOW	dB [A]	27/27	29/29	30/30
QUIET	dB [A]	25/25	27/27	27/27
DIMENSIONS & WEIGHT				
HEIGHT	[mm]	245		
WIDTH	[mm]	570		
DEPTH	[mm]	570		
WEIGHT	[kg]	15	15.5	