

Product fiche according to Commission Delegated Regulation (EU) 626/2011

MODEL	OUTDOOR UNIT		AOHG30KBTB								AOHG36KBTB							
	INDOOR UNIT		AUXG30KRLB		ABHG30KRTA		ARXG30KMLA		ARXG30KHTAP		AUXG36KRLB		ABHG36KRTA		ARXG36KMLA		ARXG36KHTAP	
			COOLING	HEATING	COOLING	HEATING	COOLING	HEATING	COOLING	HEATING	COOLING	HEATING	COOLING	HEATING	COOLING	HEATING	COOLING	HEATING
SOUND POWER LEVEL	OUTDOOR UNIT [dB(A)]		68	69	68	69	68	69	68	69	70	70	70	70	70	70	70	70
	INDOOR UNIT [dB(A)]		54	54	60	60	65	69	63	65	58	58	59	59	65	70	64	63
REFRIGERANT/GLOBAL WARMING POTENTIAL			R32 / 675 (IPCC AR4) (*)															
SEASONAL ENERGY EFFICIENCY RATIO/ SEASONAL COEFFICIENT OF PERFORMANCE (*)			6.70	4.30	6.10	4.00	6.23	4.00	6.23	4.00	6.55	4.30	6.37	4.21	6.10	4.00	6.10	4.20
ENERGY EFFICIENCY CLASS (*)			A++	A+	A++	A+	A++	A+	A++	A+	A++	A+	A++	A+	A++	A+	A++	A+
ANNUAL ENERGY CONSUMPTION (Q _{CE})(Q _{HE}) (*)			444 (*)	2601 (*)	486 (*)	2796 (*)	477 (*)	2797 (*)	477 (*)	2796 (*)	507 (*)	2828 (*)	524 (*)	2904 (*)	545 (*)	3044 (*)	544 (*)	2898 (*)
P _{design} (*)			8.50	8.00	8.50	8.00	8.50	8.00	8.50	8.00	9.50	8.70	9.50	8.70	9.50	8.70	9.50	8.70
BACKUP HEATER CAPACITY/ DECLARED CAPACITY (*)			—	0.96/ 7.04	—	0.99/ 7.01	—	1.03/ 6.97	—	1.22/ 6.78	—	1.02/ 7.68	—	1.12/ 7.58	—	1.06/ 7.64	—	1.05/ 7.65

NOTES

- (*) Refrigerant leakage contributes to climate change. Refrigerant with lower global warming potential (GWP) would contribute less to global warming than a refrigerant with higher GWP, if leaked to the atmosphere. This appliance contains a refrigerant fluid with a GWP equal to [675]. This means that if 1 kg of this refrigerant fluid would be leaked to the atmosphere, the impact on global warming would be [675] times higher than 1 kg of CO₂, over a period of 100 years. Never try to interfere with the refrigerant circuit yourself or disassemble the product yourself and always ask a professional.
- (*) Energy consumption "Q_{CE}" kWh per year based on standard test results. Actual energy consumption will depend on how the appliance is used and where it is located.
- (*) Energy consumption "Q_{HE}" kWh per year, based on standard test results. Actual energy consumption will depend on how the appliance is used and where it is located.
- (*) Climate condition: First line is Average, second line is Warmer, third line is Colder.
- (*) Pdesign temperature: (COOLING) 35°C (HEATING) Average: -10°C, Warmer: 2°C, Colder: -22°C

Specifications

The following items (A)-(D) are the information affixed to the pressure equipment in accordance with Annex I point 3.4b of Directive 2014/68/EU.

MODEL	(A) OUTDOOR UNIT		AOHG30KBTB								AOHG36KBTB									
	INDOOR UNIT		AUXG30KRLB		ABHG30KRTA		ARXG30KMLA		ARXG30KHTAP		AUXG36KRLB		ABHG36KRTA		ARXG36KMLA		ARXG36KHTAP			
TYPE			CASSETTE		CEILING		DUCT		DUCT		CASSETTE		CEILING		DUCT		DUCT			
MAX. PRESSURE (B) HIGH / DISCHARGE [bar(MPa)]			42.0 (4.20)																	
PRESSURE (C) LOW / SUCTION [bar(MPa)]			27.6 (2.76)																	
(D) MANUFACTURING DATE			Refer to the rating label																	
POWER RESOURCE			1φ 230 V ~ 50 Hz																	
CAPACITY [kW]			8.50	10.00	8.50	10.00	8.50	10.00	8.50	10.00	9.50	10.80	9.50	10.80	9.50	10.80	9.50	10.80		
POWER INPUT [kW]			2.440	2.510	2.650	2.770	2.650	2.630	2.650	2.630	2.910	2.450	2.960	2.880	2.970	2.880	2.860	2.480		
CURRENT [A]			10.8	11.1	11.7	12.2	11.7	11.7	11.7	11.7	12.9	10.9	13.1	12.7	13.1	12.8	12.6	11.0		
MAX. CURRENT [A]			22.6																	
ENERGY EFFICIENCY RATIO/ COEFFICIENT OF PERFORMANCE [kW/kW]			3.49	3.98	3.21	3.61	3.21	3.80	3.21	3.80	3.26	4.40	3.21	3.75	3.20	3.75	3.32	4.35		
DIMENSION (H×W×D)			OUTDOOR UNIT [mm]		788 × 940 × 320															
			INDOOR UNIT (GRILLE) [mm]		288 × 840 × 840 (53 × 950 × 950)		235 × 1390 × 705		270 × 1135 × 700		300 × 1000 × 700		288 × 840 × 840 (53 × 950 × 950)		235 × 1700 × 705		270 × 1135 × 700		300 × 1400 × 700	
WEIGHT			OUTDOOR UNIT [kg]		52															
			INDOOR UNIT (GRILLE) [kg]		26 (6.0)		31		38		36		29 (6.0)		38		38		46	
REFRIGERANT CHARGE (Tons - CO ₂ equivalent)			[kg]		1.90 (1.283)															

- For more information, visit our web site at: www.fujitsu-general.com
- For spare parts inquiry, consult the store that you purchased the product.
- Sound pressure level : less than 70 dB(A) by according to IEC 704-1.

OPERATING RANGE	INDOOR	OUTDOOR
COOLING/DRY [°C]	18 to 32	-15 to 46
HEATING [°C]	16 to 30	-15 to 24
HUMIDITY [%]	80 or less	—

- If the air conditioner is operated under the conditions except the permissible temperature range, the air conditioner may stop because of the automatic protection circuit working.
- Depending on the operating conditions, the heat exchanger may freeze during the Cooling or Dry mode and it may cause water leakage and other damage.
- If the unit is used for long periods under high-humidity conditions, condensation may form on the surface of the indoor unit, and drip onto the floor or other objects underneath.

[Original instructions]



PART No. 9384522023 (En)

FUJITSU GENERAL LIMITED
3-3-17, Suenaga, Takatsu-ku, Kawasaki 213-8502, Japan

The image of rating label

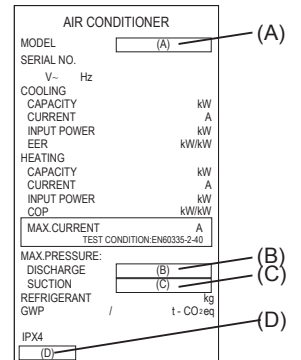

Produktdatenblatt gemäß der delegierten Kommissionsverordnung (EU) 626/2011

MODELL	AUSSENGERÄT		AOHG30KBTB								AOHG36KBTB							
	INNENGERÄT		AUXG30KRLB		ABHG30KRTA		ARXG30KMLA		ARXG30KHTAP		AUXG36KRLB		ABHG36KRTA		ARXG36KMLA		ARXG36KHTAP	
			KÜHLEN	HEIZEN	KÜHLEN	HEIZEN	KÜHLEN	HEIZEN	KÜHLEN	HEIZEN	KÜHLEN	HEIZEN	KÜHLEN	HEIZEN	KÜHLEN	HEIZEN	KÜHLEN	HEIZEN
SCHALLLEIS- TUNGSPEL	AUSSENGERÄT [dB(A)]		68	69	68	69	68	69	68	69	70	70	70	70	70	70	70	70
	INNENGERÄT [dB(A)]		54	54	60	60	65	69	63	65	58	58	59	59	65	70	64	63
KÄLTEMITTEL/GLOBALES ERWÄRMUNGSPOTENZIAL			R32 / 675 (IPCC AR4) ^{(*)1}															
SAISONALER ENERGIEEFFIZIENZANTEIL/ SAISONALER Koeffizient DER LEISTUNG ^{(*)4}			6,70	4,30	6,10	4,00	6,23	4,00	6,23	4,00	6,55	4,30	6,37	4,21	6,10	4,00	6,10	4,20
			—	—	—	—	—	—	—	—	—	—	—	—	—	—	—	—
			—	—	—	—	—	—	—	—	—	—	—	—	—	—	—	—
ENERGIEEFFIZIENZKLASSE ^{(*)4}			A++	A+	A++	A+	A++	A+	A++	A+	A++	A+	A++	A+	A++	A+	A++	A+
			—	—	—	—	—	—	—	—	—	—	—	—	—	—	—	—
			—	—	—	—	—	—	—	—	—	—	—	—	—	—	—	—
JÄHRLICHER ENERGIE VERBRAUCH (Q _{CE} /Q _{HE}) ^{(*)4}	[kWh/a]		444 ^{(*)2}	2601 ^{(*)3}	486 ^{(*)2}	2796 ^{(*)3}	477 ^{(*)2}	2797 ^{(*)3}	477 ^{(*)2}	2796 ^{(*)3}	507 ^{(*)2}	2828 ^{(*)3}	524 ^{(*)2}	2904 ^{(*)3}	545 ^{(*)2}	3044 ^{(*)3}	544 ^{(*)2}	2898 ^{(*)3}
			—	—	—	—	—	—	—	—	—	—	—	—	—	—	—	—
			—	—	—	—	—	—	—	—	—	—	—	—	—	—	—	—
P _{design} ^{(*)5}	[kW]		8,50	8,00	8,50	8,00	8,50	8,00	8,50	8,00	9,50	8,70	9,50	8,70	9,50	8,70	9,50	8,70
			—	—	—	—	—	—	—	—	—	—	—	—	—	—	—	—
			—	—	—	—	—	—	—	—	—	—	—	—	—	—	—	—
BACKUP HEIZLEISTUNG AUSGEWIESENE KAPAZITÄT ^{(*)4}	[kW]		—	0,96/ 7,04	—	0,99/ 7,01	—	1,03/ 6,97	—	1,22/ 6,78	—	1,02/ 7,68	—	1,12/ 7,58	—	1,06/ 7,64	—	1,05/ 7,65
			—	—	—	—	—	—	—	—	—	—	—	—	—	—	—	—
			—	—	—	—	—	—	—	—	—	—	—	—	—	—	—	—

HINWEISE

- ^{(*)1} Der Austritt von Kältemittel trägt zum Klimawandel bei. Kältemittel mit geringerem Treibhauspotenzial tragen im Fall eines Austritts weniger zur Erderwärmung bei als solche mit höherem Treibhauspotenzial, wenn es in die Atmosphäre gelangt. Dieses Gerät enthält Kältemittel mit einem Treibhauspotenzial von [675]. Somit hätte ein Austritt von 1 kg dieses Kältemittels [675] Mal größere Auswirkungen auf die Erderwärmung als 1 kg CO₂, bezogen auf hundert Jahre. Keine Arbeiten am Kältekreislauf selbst vornehmen oder das Gerät zerlegen – stets Fachpersonal hinzuziehen.
- ^{(*)2} Energieverbrauch „Q_{CE}“ kWh/Jahr, auf der Grundlage von Ergebnissen der Normprüfung. Der tatsächliche Verbrauch hängt von der Nutzung und vom Standort des Geräts ab.
- ^{(*)3} Energieverbrauch „Q_{HE}“ kWh/Jahr, auf der Grundlage von Ergebnissen der Normprüfung. Der tatsächliche Verbrauch hängt von der Nutzung und vom Standort des Geräts ab.
- ^{(*)4} Klimabedingung: Die erste Zeile ist Durchschnitt, die zweite Zeile ist wärmer, die dritte Zeile ist kälter.
- ^{(*)5} P_{design}-Temperatur: (KÜHLEN) 35°C (HEIZEN) Durchschnitt: -10°C, wärmer: 2°C, kälter: -22°C

Spezifikationen

Die folgenden Punkte (A) ~ (D) sind die auf dem Druckgerät gemäß Anhang I Nummer 3.4b der Richtlinie 2014/68/EU angebrachten Informationen.

MODELL	(A)	AUSSENGERÄT		AOHG30KBTB								AOHG36KBTB							
		INNENGERÄT		AUXG30KRLB		ABHG30KRTA		ARXG30KMLA		ARXG30KHTAP		AUXG36KRLB		ABHG36KRTA		ARXG36KMLA		ARXG36KHTAP	
TYP				KASSETTE		DACH		KANAL		KASSETTE		DACH		KANAL					
		EINFACH GETEILT / HEIZPUMPE																	
MAX. DRUCK	(B)	HOCH / ENTLADEN [bar(MPa)]		42,0 (4,20)															
	(C)	NIEDRIG / SAUGEN [bar(MPa)]		27,6 (2,76)															
(D)HERSTELLUNGSDATUM		Siehe Typenschild																	
STROMQUELLE		1φ 230 V ~ 50 Hz																	
LEISTUNG	[kW]	KÜHLEN	HEIZEN	KÜHLEN	HEIZEN	KÜHLEN	HEIZEN	KÜHLEN	HEIZEN	KÜHLEN	HEIZEN	KÜHLEN	HEIZEN	KÜHLEN	HEIZEN	KÜHLEN	HEIZEN		
EINGANGSLEISTUNG	[kW]	8,50	10,00	8,50	10,00	8,50	10,00	8,50	10,00	9,50	10,80	9,50	10,80	9,50	10,80	9,50	10,80		
STROMSTÄRKE	[A]	10,8	11,1	11,7	12,2	11,7	11,7	11,7	11,7	12,9	10,9	13,1	12,7	13,1	12,8	12,6	11,0		
MAX. STROMSTÄRKE	[A]	22,6																	
ENERGIEEFFIZIENZANTEIL/ Koeffizient DER LEISTUNG	[kW/kW]	3,49	3,98	3,21	3,61	3,21	3,80	3,21	3,80	3,26	4,40	3,21	3,75	3,20	3,75	3,32	4,35		
ABMESSUNG (H×B×T)		AUSSENGERÄT [mm]		788 × 940 × 320															
		INNENGERÄT (GITTER) [mm]		288 × 840 × 840 (53 × 950 × 950)		235 × 1390 × 705		270 × 1135 × 700		300 × 1000 × 700		288 × 840 × 840 (53 × 950 × 950)		235 × 1700 × 705		270 × 1135 × 700		300 × 1400 × 700	
GEWICHT		AUSSENGERÄT [kg]		52															
		INNENGERÄT (GITTER) [kg]		26 (6,0)		31		38		36		29 (6,0)		38		38		46	
KÄLTEMITTELFÜLLUNG (Tonnen - CO ₂ Äquivalent)	[kg] (t-CO ₂ eq)	1,90 (1,283)																	

- Weitere Informationen finden Sie auf unserer Webseite unter: www.fujitsu-general.com
- Anfragen zu Ersatzteilen stellen Sie bitte an das Geschäft, wo Sie das Produkt gekauft haben.
- Schalldruckpegel: weniger als 70 dB(A) gemäß IEC 704-1.

BETRIEBSBEREICH		INNEN	AUSSEN
KÜHLEN/TROCKNEN	[°C]	18 bis 32	-15 bis 46
HEIZEN	[°C]	16 bis 30	-15 bis 24
FEUCHTIGKEIT	[%]	80 oder weniger	—

- Wenn die Klimaanlage unter den Bedingungen mit Ausnahme des zulässigen Temperaturbereichs betrieben wird, stoppt die Klimaanlage möglicherweise, weil die automatische Schutzschaltung arbeitet.
- Abhängig von den Betriebsbedingungen kann der Wärmetauscher während des Kühl- oder Trockenmodus einfrieren und Wasserlecks und andere Schäden verursachen.
- Wenn das Gerät längere Zeit bei hoher Luftfeuchtigkeit verwendet wird, kann sich Kondensation auf der Oberfläche des Innengeräts bilden und auf den Boden oder auf andere Gegenstände darunter fallen.

Bild des Typenschilds

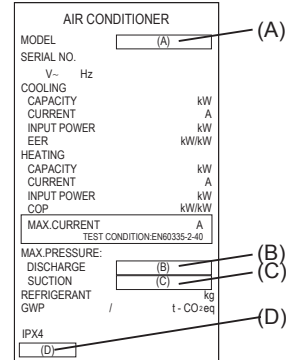

■ Fiche produit conforme au Règlement délégué (UE) 626/2011 de la commission

MODÈLE	UNITÉ EXTÉRIEUR		AOHG30KBTB								AOHG36KBTB							
	UNITÉ INTÉRIEURE		AUXG30KRLB		ABHG30KRTA		ARXG30KMLA		ARXG30KHTAP		AUXG36KRLB		ABHG36KRTA		ARXG36KMLA		ARXG36KHTAP	
			REFROIDISSEMENT	CHAUFFAGE	REFROIDISSEMENT	CHAUFFAGE	REFROIDISSEMENT	CHAUFFAGE	REFROIDISSEMENT	CHAUFFAGE	REFROIDISSEMENT	CHAUFFAGE	REFROIDISSEMENT	CHAUFFAGE	REFROIDISSEMENT	CHAUFFAGE	REFROIDISSEMENT	CHAUFFAGE
NIVEAU DE PUISSANCE SONORE	UNITÉ EXTÉRIEUR [dB(A)]		68	69	68	69	68	69	68	69	70	70	70	70	70	70	70	70
	UNITÉ INTÉRIEURE [dB(A)]		54	54	60	60	65	69	63	65	58	58	59	59	65	70	64	63
POTENTIEL RÉFRIGÉRANT/POTENTIEL DE RÉCHAUFFEMENT GLOBAL			R32 / 675 (IPCC AR4) ^(*)															
RATIO D'EFFICACITÉ ÉNERGÉTIQUE SAISONNIER/COEFFICIENT DE PERFORMANCE SAISONNIER ^(*)			6,70	4,30	6,10	4,00	6,23	4,00	6,23	4,00	6,55	4,30	6,37	4,21	6,10	4,00	6,10	4,20
CLASSE D'EFFICACITÉ ÉNERGÉTIQUE ^(*)			A++	A+	A++	A+	A++	A+	A++	A+	A++	A+	A++	A+	A++	A+	A++	A+
CONSOMMATION ÉNERGÉTIQUE ANNUELLE (Q _{CE})/Q _{HE} ^(*)			444 ^(*)	2601 ^(*)	486 ^(*)	2796 ^(*)	477 ^(*)	2797 ^(*)	477 ^(*)	2796 ^(*)	507 ^(*)	2828 ^(*)	524 ^(*)	2904 ^(*)	545 ^(*)	3044 ^(*)	544 ^(*)	2898 ^(*)
P _{design} ^(*)			8,50	8,00	8,50	8,00	8,50	8,00	8,50	8,00	9,50	8,70	9,50	8,70	9,50	8,70	9,50	8,70
CAPACITÉ DU CHAUFFAGE DE RECHANGE/CAPACITÉ DÉCLARÉE ^(*)			—	0,96/7,04	—	0,99/7,01	—	1,03/6,97	—	1,22/6,78	—	1,02/7,68	—	1,12/7,58	—	1,06/7,64	—	1,05/7,65

REMARQUES

- ^(*) Les fuites de réfrigérants accentuent le changement climatique. En cas de fuite, l'impact sur le réchauffement de la planète sera d'autant plus limité que le potentiel de réchauffement planétaire (PRP) du réfrigérant est faible. Cet appareil utilise un réfrigérant dont le PRP est égal à [675]. En d'autres termes, si 1 kg de ce réfrigérant est relâché dans l'atmosphère, son impact sur le réchauffement de la planète sera [675] fois supérieur à celui d'1 kg de CO₂, sur une période de 100 ans. Ne tentez jamais d'intervenir dans le circuit frigorifique et de démonter les pièces vous-même et adressez-vous systématiquement à un professionnel.
- ^(*) Consommation d'énergie de « Q_{CE} » kWh par an, déterminée sur la base des résultats obtenus dans des conditions d'essai normalisées. La consommation d'énergie réelle dépend des conditions d'utilisation et de l'emplacement de l'appareil.
- ^(*) Consommation d'énergie de « Q_{HE} » kWh par an, déterminée sur la base des résultats obtenus dans des conditions d'essai normalisées. La consommation d'énergie réelle dépend des conditions d'utilisation et de l'emplacement de l'appareil.
- ^(*) Condition de climatisation: la première ligne correspond à une température moyenne, la deuxième ligne à une température plus chaude et la troisième ligne est pour une température plus froide.
- ^(*) Température de P_{design}: (REFROIDISSEMENT) 35°C (CHAUFFAGE) Moyenne: -10°C, Plus chaude: 2°C, Plus froide: -22°C

■ Caractéristiques

Les points suivants (A) à (D) sont les informations apposées sur l'équipement sous pression conformément à l'annexe I point 3.4b de la directive 2014/68/UE.

MODÈLE	(A) UNITÉ EXTÉRIEUR	AOHG30KBTB								AOHG36KBTB									
		UNITÉ INTÉRIEURE		AUXG30KRLB		ABHG30KRTA		ARXG30KMLA		ARXG30KHTAP		AUXG36KRLB		ABHG36KRTA		ARXG36KMLA		ARXG36KHTAP	
TYPE		CASSETTE		PLAFOND		CONDUIT		CONDUIT		CASSETTE		PLAFOND		CONDUIT		CONDUIT			
MAX. PRESSION		ÉLEVÉ / DÉCHARGE [bar(MPa)]		42,0 (4,20)															
(C) BAS / ASPIRATION [bar(MPa)]		27,6 (2,76)																	
(D) DATE DE FABRICATION		Consultez l'étiquette des spécifications																	
ALIMENTATION		1φ 230 V ~ 50 Hz																	
CAPACITÉ		[kW]	8,50	10,00	8,50	10,00	8,50	10,00	8,50	10,00	9,50	10,80	9,50	10,80	9,50	10,80	9,50	10,80	
PUISSANCE D'ENTRÉE		[kW]	2,440	2,510	2,650	2,770	2,650	2,630	2,650	2,630	2,910	2,450	2,960	2,880	2,970	2,880	2,860	2,480	
COURANT		[A]	10,8	11,1	11,7	12,2	11,7	11,7	11,7	12,9	10,9	13,1	12,7	13,1	12,8	12,6	11,0		
COURANT MAX.		[A]	22,6																
RATIO D'EFFICACITÉ ÉNERGÉTIQUE/COEFFICIENT DE PERFORMANCE		[kW/kW]	3,49	3,98	3,21	3,61	3,21	3,80	3,21	3,80	3,26	4,40	3,21	3,75	3,20	3,75	3,32	4,35	
DIMENSION (H×L×P)		UNITÉ EXTÉRIEUR [mm]	788 × 940 × 320																
		UNITÉ INTÉRIEURE (GRILLE) [mm]	288 × 840 × 840 (53 × 950 × 950)	235 × 1390 × 705	270 × 1135 × 700	300 × 1000 × 700	288 × 840 × 840 (53 × 950 × 950)	235 × 1700 × 705	270 × 1135 × 700	300 × 1400 × 700									
POIDS		UNITÉ EXTÉRIEUR [kg]	52																
		UNITÉ INTÉRIEURE (GRILLE) [kg]	26 (6,0)	31	38	36	29 (6,0)	38	38	38	38	38	38	38	38	38	46		
CHARGE DE RÉFRIGÉRANT (Tonnes - équivalent CO ₂)		[kg] (t-CO ₂ eq)	1,90 (1,283)																

- Pour plus d'informations; rendez-vous sur notre site web : www.fujitsu-general.com
- Pour des renseignements concernant des pièces de rechange, consultez le magasin dans lequel vous avez acheté le produit.
- Niveau de pression sonore : inférieur à 70 dB (A) conformément à la norme CEI 704-1.

PLAGE DE FONCTIONNEMENT	INTÉRIEUR	EXTÉRIEUR
REFROIDISSEMENT/DÉSHUMIDIFICATION [°C]	18 à 32	-15 à 46
CHAUFFAGE [°C]	16 à 30	-15 à 24
HUMIDITÉ [%]	80 ou moins	—

- Si le climatiseur est utilisé à des températures en dehors de la plage autorisée, le climatiseur risque de s'arrêter en raison de l'activation du circuit de protection automatique.
- Durant les modes Refroidissement et Déshumidification, en fonction des conditions d'utilisation, l'échangeur de chaleur risque de geler, provoquant des fuites d'eau et d'autres dommages.
- Si l'unité est utilisée pendant de longues périodes dans des conditions extrêmement humides, de la condensation risque de se former sur la surface de l'unité intérieure et de s'égoutter sur le sol ou les objets situés en-dessous.

■ Image de l'étiquette de spécification

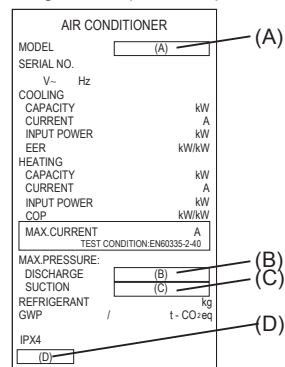

Ficha de producto de acuerdo con la Regulación Delegada de la Comisión (UE) 626/2011

MODELO	UNIDAD EXTERIOR	AOHG30KBTB								AOHG36KBTB							
	UNIDAD INTERIOR	AUXG30KRLB	ABHG30KRTA	ARXG30KMLA	ARXG30KHTAP	AUXG36KRLB	ABHG36KRTA	ARXG36KMLA	ARXG36KHTAP	AUXG36KRLB	ABHG36KRTA	ARXG36KMLA	ARXG36KHTAP				
		REFRIGERACIÓN	CALEFACCIÓN	REFRIGERACIÓN	CALEFACCIÓN	REFRIGERACIÓN	CALEFACCIÓN	REFRIGERACIÓN	CALEFACCIÓN	REFRIGERACIÓN	CALEFACCIÓN	REFRIGERACIÓN	CALEFACCIÓN	REFRIGERACIÓN	CALEFACCIÓN		
NIVEL DE POTENCIA DE SONIDO	UNIDAD EXTERIOR [dB(A)]	68	69	68	69	68	69	68	69	70	70	70	70	70	70		
	UNIDAD INTERIOR [dB(A)]	54	54	60	60	65	69	63	65	58	58	59	59	65	70		
REFRIGERANTE/POTENCIAL DE CALENTAMIENTO GLOBAL		R32 / 675 (IPCC AR4) ^(*)															
RELACIÓN DE EFICIENCIA ENERGÉTICA ESTACIONAL/COEFICIENTE DE RENDIMIENTO ESTACIONAL ^(*)		6,70	4,30	6,10	4,00	6,23	4,00	6,23	4,00	6,55	4,30	6,37	4,21	6,10	4,00	6,10	4,20
CLASE DE EFICIENCIA ENERGÉTICA ^(*)		A++	A+	A++	A+	A++	A+	A++	A+	A++	A+	A++	A+	A++	A+	A++	A+
CONSUMO ENERGÉTICO ANUAL (Q _{CE} /Q _{HE}) ^(*)	[kWh/a]	444 ⁽²⁾	2601 ⁽³⁾	486 ⁽²⁾	2796 ⁽³⁾	477 ⁽²⁾	2797 ⁽³⁾	477 ⁽²⁾	2796 ⁽³⁾	507 ⁽²⁾	2828 ⁽³⁾	524 ⁽²⁾	2904 ⁽³⁾	545 ⁽²⁾	3044 ⁽³⁾	544 ⁽²⁾	2898 ⁽³⁾
P _{diseño} ^(*)	[kW]	8,50	8,00	8,50	8,00	8,50	8,00	8,50	8,00	9,50	8,70	9,50	8,70	9,50	8,70	9,50	8,70
CAPACIDAD DEL CALENTADOR AUXILIAR/CAPACIDAD DECLARADA ^(*)	[kW]	—	0,96/7,04	—	0,99/7,01	—	1,03/6,97	—	1,22/6,78	—	1,02/7,68	—	1,12/7,58	—	1,06/7,64	—	1,05/7,65

NOTAS

- (*) Las fugas de refrigerante contribuyen al cambio climático. Cuanto mayor sea el potencial de calentamiento global (GWP) de un refrigerante, más contribuirá a dicho calentamiento su vertido a la atmósfera. Este aparato contiene un líquido refrigerante con un GWP igual a [675]. Esto significa que, si pasara a la atmósfera 1 kg de este líquido refrigerante, el impacto en el calentamiento global sería, a lo largo de un periodo de 100 años, [675] veces mayor que si se vertiera 1 kg de CO₂. Nunca intente intervenir en el circuito del refrigerante ni desmontar el aparato usted mismo; consulte siempre a un profesional.
- (2) Consumo de energía "Q_{CE}" kWh/año, según los resultados obtenidos en ensayos estándar. El consumo de energía real depende de las condiciones de uso del aparato y del lugar en el que esté instalado.
- (3) Consumo de energía "Q_{HE}" kWh/año, según los resultados obtenidos en ensayos estándar. El consumo de energía real depende de las condiciones de uso del aparato y del lugar en el que esté instalado.
- (4) Condición climática: La primera fila es Promedio, la segunda fila es Más Caliente, la tercera fila es Más Fría.
- (5) Temperatura de P_{diseño}: (REFRIGERACIÓN) 35°C (CALEFACCIÓN) Promedio: -10°C, Más Caliente 2°C, Más Fría: -22°C

Especificaciones

Los siguientes elementos (A)-(D) son la información adjunta al equipo a presión de acuerdo con el Anexo I, punto 3.4b, de la Directiva 2014/68/UE.

MODELO	(A)	UNIDAD EXTERIOR	AOHG30KBTB								AOHG36KBTB							
		UNIDAD INTERIOR	AUXG30KRLB	ABHG30KRTA	ARXG30KMLA	ARXG30KHTAP	AUXG36KRLB	ABHG36KRTA	ARXG36KMLA	ARXG36KHTAP								
TIPO			CASSETTE	TECHO	CONDUCTO				CASSETTE	TECHO	CONDUCTO							
MÁX. PRESIÓN	(B)	ALTA / DESCARGA [bar(MPa)]	42,0 (4,20)															
	(C)	BAJA / SUCCIÓN [bar(MPa)]	27,6 (2,76)															
(D)FECHA DE FABRICACIÓN			Consulte la etiqueta de calificación															
FUENTE DE ALIMENTACIÓN			1φ 230 V ~ 50 Hz															
			REFRIGERACIÓN	CALEFACCIÓN	REFRIGERACIÓN	CALEFACCIÓN	REFRIGERACIÓN	CALEFACCIÓN	REFRIGERACIÓN	CALEFACCIÓN	REFRIGERACIÓN	CALEFACCIÓN	REFRIGERACIÓN	CALEFACCIÓN	REFRIGERACIÓN	CALEFACCIÓN		
CAPACIDAD	[kW]		8,50	10,00	8,50	10,00	8,50	10,00	8,50	10,00	9,50	10,80	9,50	10,80	9,50	10,80		
POTENCIA DE ENTRADA	[kW]		2,440	2,510	2,650	2,770	2,650	2,630	2,650	2,630	2,910	2,450	2,960	2,880	2,970	2,880		
CORRIENTE	[A]		10,8	11,1	11,7	12,2	11,7	11,7	11,7	12,9	10,9	13,1	12,7	13,1	12,8	12,6		
CORRIENTE MÁX.	[A]		22,6															
RELACIÓN DE EFICIENCIA ENERGÉTICA/ COEFICIENTE DE RENDIMIENTO	[kW/kW]		3,49	3,98	3,21	3,61	3,21	3,80	3,21	3,80	3,26	4,40	3,21	3,75	3,20	3,75		
DIMENSIONES (AL×AN×PROF)		UNIDAD EXTERIOR [mm]	788 × 940 × 320															
		UNIDAD INTERIOR (REJILLA) [mm]	288 × 840 × 840 (53 × 950 × 950)	235 × 1390 × 705	270 × 1135 × 700	300 × 1000 × 700	288 × 840 × 840 (53 × 950 × 950)	235 × 1700 × 705	270 × 1135 × 700	300 × 1400 × 700								
PESO		UNIDAD EXTERIOR [kg]	52															
		UNIDAD INTERIOR (REJILLA) [kg]	26 (6,0)	31	38	36	29 (6,0)	38	38	46								
CARGA DE REFRIGERANTE (Equivalente en toneladas de CO ₂)	[kg] (t-CO ₂ eq)		1,90 (1,283)															

- Para obtener más información, visite nuestro sitio web www.fujitsu-general.com
- Para solicitar piezas de repuesto, consulte con el establecimiento donde adquirió el producto.
- Nivel de presión del sonido: inferior a 70 dB(A) según IEC 704-1.

RANGO OPERATIVO	INTERIOR	EXTERIOR
REFRIGERACIÓN/SECO	[°C] 18 a 32	-15 a 46
CALEFACCIÓN	[°C] 16 a 30	-15 a 24
HUMEDAD	[%] 80 o menos	—

- Si el aire acondicionado funciona en condiciones que superan el rango de temperatura permitido, el acondicionador de aire puede detenerse debido a que el circuito de protección automática está funcionando.
- Dependiendo de las condiciones de funcionamiento, el intercambiador de calor puede congelarse durante el modo de Enfriamiento o Seco y puede causar fugas de agua y otros daños.
- Si la unidad se usa durante largos periodos en condiciones de alta humedad, puede formarse condensación en la superficie de la unidad interior y gotear en el piso u otros objetos debajo.

La imagen de la etiqueta de calificación

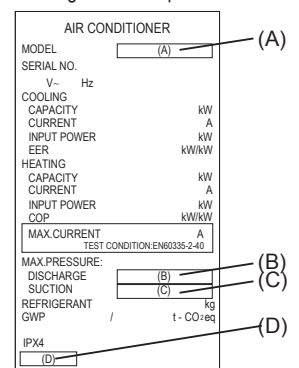

Schema prodotto conforme al regolamento delegato (UE) n. 626/2011 della Commissione

MODELLO	UNITÀ ESTERNA		AOHG30KBTB								AOHG36KBTB							
	UNITÀ INTERNA		AUXG30KRLB		ABHG30KRTA		ARXG30KMLA		ARXG30KHTAP		AUXG36KRLB		ABHG36KRTA		ARXG36KMLA		ARXG36KHTAP	
			RAFFREDDAMENTO	RISCALDAMENTO	RAFFREDDAMENTO	RISCALDAMENTO	RAFFREDDAMENTO	RISCALDAMENTO	RAFFREDDAMENTO	RISCALDAMENTO	RAFFREDDAMENTO	RISCALDAMENTO	RAFFREDDAMENTO	RISCALDAMENTO	RAFFREDDAMENTO	RISCALDAMENTO	RAFFREDDAMENTO	RISCALDAMENTO
LIVELLO DI POTENZA SONORA	UNITÀ ESTERNA [dB(A)]		68	69	68	69	68	69	68	69	70	70	70	70	70	70	70	70
	UNITÀ INTERNA [dB(A)]		54	54	60	60	65	69	63	65	58	58	59	59	65	70	64	63
REFRIGERANTE/POTENZIALE DI RISCALDAMENTO GLOBALE			R32 / 675 (IPCC AR4) (*)															
INDICE DI EFFICIENZA ENERGETICA STAGIONALE/COEFFICIENTE DI PRESTAZIONE STAGIONALE (*)			6,70	4,30	6,10	4,00	6,23	4,00	6,23	4,00	6,55	4,30	6,37	4,21	6,10	4,00	6,10	4,20
CLASSE DI EFFICIENZA ENERGETICA (*)			A++	A+	A++	A+	A++	A+	A++	A+	A++	A+	A++	A+	A++	A+	A++	A+
CONSUMO ENERGETICO ANNUALE (Q _{CE})(Q _{HE}) (*)			444 (*)	2601 (*)	486 (*)	2796 (*)	477 (*)	2797 (*)	477 (*)	2796 (*)	507 (*)	2828 (*)	524 (*)	2904 (*)	545 (*)	3044 (*)	544 (*)	2898 (*)
P _{design} (*)			8,50	8,00	8,50	8,00	8,50	8,00	8,50	8,00	9,50	8,70	9,50	8,70	9,50	8,70	9,50	8,70
POTENZA DEL RISCALDATORE DI SICUREZZA/POTENZA DICHIARATA (*)			—	0,96/7,04	—	0,99/7,01	—	1,03/6,97	—	1,22/6,78	—	1,02/7,68	—	1,12/7,58	—	1,06/7,64	—	1,05/7,65

NOTE

- (*) La perdita di refrigerante contribuisce al cambiamento climatico. In caso di rilascio nell'atmosfera, i refrigeranti con un potenziale di riscaldamento globale (GWP) più basso contribuiscono in misura minore al riscaldamento globale rispetto a quelli con un GWP più elevato. Questo apparecchio contiene un fluido refrigerante con un GWP di [675]. Quindi, se 1 kg di questo fluido refrigerante fosse rilasciato nell'atmosfera, l'impatto sul riscaldamento globale sarebbe [675] volte più elevato rispetto a 1 kg di CO₂, per un periodo di 100 anni. In nessun caso l'utente deve cercare di intervenire sul circuito refrigerante o di disassemblare il prodotto. In caso di necessità occorre sempre rivolgersi a personale qualificato.
- (*) Consumo di energia "Q_{CE}" kWh/anno in base ai risultati di prove standard. Il consumo effettivo dipende dalle modalità di utilizzo dell'apparecchio e dal luogo in cui è installato.
- (*) Consumo di energia "Q_{HE}" kWh/anno in base ai risultati di prove standard. Il consumo effettivo dipende dalle modalità di utilizzo dell'apparecchio e dal luogo in cui è installato.
- (*) Condizioni climatiche: la prima riga è nella Media, la seconda riga è Più Calda, la terza riga è Più Fredda.
- (*) Temperatura di P_{design}: (RAFFREDDAMENTO) 35°C (RISCALDAMENTO) Media: -10°C, Più calda: 2°C, Più fredda: -22°C

Specifiche

Le seguenti voci (A)-(D) sono le informazioni riportate sull'attrezzatura a pressione in conformità con l'Allegato I punto 3.4b della Direttiva 2014/68/UE.

MODELLO	(A) UNITÀ ESTERNA UNITÀ INTERNA	AOHG30KBTB								AOHG36KBTB									
		AUXG30KRLB		ABHG30KRTA		ARXG30KMLA		ARXG30KHTAP		AUXG36KRLB		ABHG36KRTA		ARXG36KMLA		ARXG36KHTAP			
TIPO		A CASSETTA		SOFFITTO		A CONDOTTO		A CONDOTTO		CASSETTE		SOFFITTO		A CONDOTTO		A CONDOTTO			
PRESSIONE (B) MAX.		A SPLIT SINGOLO / A POMPA DI CALORE																	
(C) BASSA / ASPIRAZIONE [bar(MPa)]		42,0 (4,20)																	
(D) DATA DI PRODUZIONE		27,6 (2,76)																	
ALIMENTAZIONE		Fare riferimento all'etichetta delle specifiche																	
		1φ 230 V ~ 50 Hz																	
CAPACITÀ [kW]		RAFFREDDAMENTO	RISCALDAMENTO	RAFFREDDAMENTO	RISCALDAMENTO	RAFFREDDAMENTO	RISCALDAMENTO	RAFFREDDAMENTO	RISCALDAMENTO	RAFFREDDAMENTO	RISCALDAMENTO	RAFFREDDAMENTO	RISCALDAMENTO	RAFFREDDAMENTO	RISCALDAMENTO	RAFFREDDAMENTO	RISCALDAMENTO		
POTENZA INGRESSO [kW]		8,50	10,00	8,50	10,00	8,50	10,00	8,50	10,00	9,50	10,80	9,50	10,80	9,50	10,80	9,50	10,80		
CORRENTE [A]		2,440	2,510	2,650	2,770	2,650	2,630	2,650	2,630	2,910	2,450	2,960	2,880	2,970	2,880	2,860	2,480		
CORRENTE MAX. [A]		10,8	11,1	11,7	12,2	11,7	11,7	11,7	11,7	12,9	10,9	13,1	12,7	13,1	12,8	12,6	11,0		
INDICE DI EFFICIENZA ENERGETICA/ COEFFICIENTE DI PRESTAZIONE [kW/kW]		22,6																	
DIMENSIONI (A x L x P)		UNITÀ ESTERNA [mm]		788 x 940 x 320															
		UNITÀ INTERNA (GRIGLIA) [mm]		288 x 840 x 840 (53 x 950 x 950)		235 x 1390 x 705		270 x 1135 x 700		300 x 1000 x 700		288 x 840 x 840 (53 x 950 x 950)		235 x 1700 x 705		270 x 1135 x 700		300 x 1400 x 700	
PESO		UNITÀ ESTERNA [kg]		52															
		UNITÀ INTERNA (GRIGLIA) [kg]		26 (6,0)		31		38		36		29 (6,0)		38		38		46	
CARICA DI REFRIGERANTE (Tonnellate - CO ₂ equivalente) [kg] (t-CO ₂ eq)		1,90 (1,283)																	

- Per ulteriori informazioni, visitare il nostro sito web: www.fujitsu-general.com
- Per richieste relative a pezzi di ricambio, rivolgersi al negozio presso il quale è stato acquistato il prodotto.
- Livello di pressione sonora: inferiore a 70 dB(A) in conformità allo standard IEC 704-1.

TEMPERATURA DI FUNZIONAMENTO	INTERNA	ESTERNA
RAFFREDDAMENTO/SECCO [°C]	da 18 a 32	da -15 a 46
RISCALDAMENTO [°C]	da 16 a 30	da -15 a 24
UMIDITÀ [%]	80 o inferiore	—

- Se il condizionatore d'aria viene azionato in condizioni diverse dalla fascia di temperature consentite, potrebbe arrestarsi per via dell'attivazione del circuito di protezione automatico.
- A seconda delle condizioni di funzionamento, lo scambiatore di calore potrebbe congelarsi durante la modalità Raffreddamento o Deumidificazione e causare perdite d'acqua e altri danni.
- Se l'unità viene utilizzata per lunghi periodi in condizioni di elevata umidità, potrebbe formarsi della condensa sulla superficie dell'unità interna con conseguente gocciolamento sul pavimento o sugli oggetti situati sotto l'unità stessa.

Immagine dell'etichetta delle specifiche

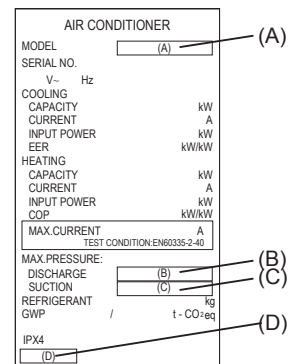

■ Δελτίο προϊόντος σύμφωνα με τον κατ' εξουσιοδότηση κανονισμό της Επιτροπής (ΕΕ) 626/2011

ΜΟΝΤΕΛΟ	ΕΞΩΤΕΡΙΚΗ ΜΟΝΑΔΑ		ΑΟΗG30ΚΒΤΒ								ΑΟΗG36ΚΒΤΒ							
	ΕΞΩΤΕΡΙΚΗ ΜΟΝΑΔΑ		ΑUXG30KRLB		ΑΒΗG30KRTA		ΑRXG30KMLA		ΑRXG30KHΤΑΡ		ΑUXG36KRLB		ΑΒΗG36KRTA		ΑRXG36KMLA		ΑRXG36KHΤΑΡ	
	ΨΥΞΗ	ΘΕΡΜΑΝΣΗ	ΨΥΞΗ	ΘΕΡΜΑΝΣΗ	ΨΥΞΗ	ΘΕΡΜΑΝΣΗ	ΨΥΞΗ	ΘΕΡΜΑΝΣΗ	ΨΥΞΗ	ΘΕΡΜΑΝΣΗ	ΨΥΞΗ	ΘΕΡΜΑΝΣΗ	ΨΥΞΗ	ΘΕΡΜΑΝΣΗ	ΨΥΞΗ	ΘΕΡΜΑΝΣΗ	ΨΥΞΗ	ΘΕΡΜΑΝΣΗ
ΕΠΙΠΕΔΟ ΘΟΡΥΒΟΥ	ΕΞΩΤΕΡΙΚΗ ΜΟΝΑΔΑ [dB(A)]		68	69	68	69	68	69	68	69	70	70	70	70	70	70	70	70
	ΕΞΩΤΕΡΙΚΗ ΜΟΝΑΔΑ [dB(A)]		54	54	60	60	65	69	63	65	58	58	59	59	65	70	64	63
ΨΥΚΤΙΚΟ/ΔΥΝΑΜΙΚΟ ΘΕΡΜΑΝΣΗΣ ΤΟΥ ΠΛΑΝΗΤΗ	R32 / 675 (IPCC AR4) (*)																	
ΕΠΟΧΙΑΚΟΣ ΒΑΘΜΟΣ ΕΝΕΡΓΙΑΚΗΣ ΑΠΟΔΟΣΗΣ/ ΕΠΟΧΙΑΚΟΣ ΣΥΝΤΕΛΕΣΤΗΣ ΑΠΟΔΟΣΗΣ (*)	6,70	4,30	6,10	4,00	6,23	4,00	6,23	4,00	6,55	4,30	6,37	4,21	6,10	4,00	6,10	4,20		
	—	—	—	—	—	—	—	—	—	—	—	—	—	—	—	—	—	
	—	—	—	—	—	—	—	—	—	—	—	—	—	—	—	—	—	
ΤΑΞΗ ΕΝΕΡΓΕΙΑΚΗΣ ΑΠΟΔΟΣΗΣ (*)	A++	A+	A++	A+	A++	A+	A++	A+	A++	A+	A++	A+	A++	A+	A++	A+	A++	
	—	—	—	—	—	—	—	—	—	—	—	—	—	—	—	—	—	
	—	—	—	—	—	—	—	—	—	—	—	—	—	—	—	—	—	
ΕΤΗΣΙΑ ΚΑΤΑΝΑΛΩΣΗ ΕΝΕΡΓΕΙΑΣ (Q _{CE})(Q _{HE}) (*)	[kWh/a]	444 (*)	2601 (*)	486 (*)	2796 (*)	477 (*)	2797 (*)	477 (*)	2796 (*)	507 (*)	2828 (*)	524 (*)	2904 (*)	545 (*)	3044 (*)	544 (*)	2898 (*)	
	—	—	—	—	—	—	—	—	—	—	—	—	—	—	—	—	—	
	—	—	—	—	—	—	—	—	—	—	—	—	—	—	—	—	—	
P _{design} (*)	[kW]	8,50	8,00	8,50	8,00	8,50	8,00	8,50	8,00	9,50	8,70	9,50	8,70	9,50	8,70	9,50	8,70	
	—	—	—	—	—	—	—	—	—	—	—	—	—	—	—	—	—	
	—	—	—	—	—	—	—	—	—	—	—	—	—	—	—	—	—	
ΙΚΑΝΟΤΗΤΑ ΕΦΕΔΡΙΚΗΣ ΘΕΡΜΑΝΣΗΣ/ ΔΗΛΟΥΜΕΝΗ ΙΚΑΝΟΤΗΤΑ (*)	[kW]	—	0,96/ 7,04	—	0,99/ 7,01	—	1,03/ 6,97	—	1,22/ 6,78	—	1,02/ 7,68	—	1,12/ 7,58	—	1,06/ 7,64	—	1,05/ 7,65	
	—	—	—	—	—	—	—	—	—	—	—	—	—	—	—	—	—	
	—	—	—	—	—	—	—	—	—	—	—	—	—	—	—	—	—	

- ΣΗΜΕΙΩΣΕΙΣ**
- (*) Διαρροή ψυκτικού μέσου συμβάλλει στην κλιματική αλλαγή. Εάν διαρρεύσει στην ατμόσφαιρα ψυκτικό μέσο με χαμηλότερο δυναμικό θέρμανσης του πλανήτη (GWP) θα συμβάλει λιγότερο στην υπερθέρμανση του πλανήτη από ψυκτικό με υψηλότερο GWP. Αυτή η συσκευή περιέχει ψυκτικό μέσο με GWP ίσο με [675]. Αυτό σημαίνει ότι εάν διαρρεύσει στην ατμόσφαιρα 1 kg του ψυκτικού μέσου, οι επιπτώσεις στην υπερθέρμανση του πλανήτη θα είναι [675] φορές μεγαλύτερες από 1 kg CO₂, σε περίοδο 100 ετών. Ποτέ μην επιχειρήσετε να επέμβετε στο κύκλωμα ψυκτικού μέσου ή να αποσυναρμολογήσετε το προϊόν και πάντοτε να απευθύνεστε σε επαγγελματία.
- (**) Κατανάλωση ενέργειας "Q_{CE}" kWh ετησίως με βάση τα αποτελέσματα πρότυπης δοκιμής. Η πραγματική κατανάλωση ενέργειας εξαρτάται από τον τρόπο χρήσης και τη θέση της συσκευής.
- (***) Κατανάλωση ενέργειας "Q_{HE}" kWh ανά έτος με βάση τα αποτελέσματα πρότυπης δοκιμής. Η πραγματική κατανάλωση ενέργειας εξαρτάται από τον τρόπο χρήσης και τη θέση της συσκευής.
- (****) Ρύθμιση κλίματος: Η πρώτη γραμμή δείχνει τη μέση τιμή, η δεύτερη τη θερμότερη και η τρίτη την ψυχρότερη.
- (*****) Θερμοκρασία P_{design}: (ΨΥΞΗ) 35°C (ΘΕΡΜΑΝΣΗ) Μέση: -10°C , Θερμότερη: 2°C , Ψυχρότερη: -22°C

■ Προδιαγραφές

Τα παρακάτω στοιχεία (A)~(D) είναι οι πληροφορίες οι οποίες είναι επικολημένες στον εξοπλισμό πίεσης, σύμφωνα με το Προσάρτημα I σημείο 3.4b της Οδηγίας 2014/68/ΕΕ.

ΜΟΝΤΕΛΟ	(A)	ΕΞΩΤΕΡΙΚΗ ΜΟΝΑΔΑ		ΑΟΗG30ΚΒΤΒ								ΑΟΗG36ΚΒΤΒ							
		ΕΞΩΤΕΡΙΚΗ ΜΟΝΑΔΑ		ΑUXG30KRLB		ΑΒΗG30KRTA		ΑRXG30KMLA		ΑRXG30KHΤΑΡ		ΑUXG36KRLB		ΑΒΗG36KRTA		ΑRXG36KMLA		ΑRXG36KHΤΑΡ	
ΤΥΠΟΣ		ΚΑΣΕΤΑΣ		ΟΡΟΦΗΣ		ΑΓΩΓΟΥ		ΑΓΩΓΟΥ		ΚΑΣΕΤΑΣ		ΟΡΟΦΗΣ		ΑΓΩΓΟΥ		ΑΓΩΓΟΥ			
ΜΕΓ. ΠΙΕΣΗ	(B)	ΥΨΗΛΗ / ΚΑΤΑΘΛΙΨΗ [bar(MPa)]		42,0 (4,20)															
	(C)	ΧΑΜΗΛΗ / ΑΝΑΡΡΟΦΗΣΗ [bar(MPa)]		27,6 (2,76)															
(D) ΗΜΕΡΟΜΗΝΙΑ ΚΑΤΑΣΚΕΥΗΣ		Ανατρέξτε στην επικέτα τεχνικών στοιχείων																	
ΠΗΓΗ ΙΣΧΥΟΣ		1φ 230 V ~ 50 Hz																	
		ΨΥΞΗ	ΘΕΡΜΑΝΣΗ	ΨΥΞΗ	ΘΕΡΜΑΝΣΗ	ΨΥΞΗ	ΘΕΡΜΑΝΣΗ	ΨΥΞΗ	ΘΕΡΜΑΝΣΗ	ΨΥΞΗ	ΘΕΡΜΑΝΣΗ	ΨΥΞΗ	ΘΕΡΜΑΝΣΗ	ΨΥΞΗ	ΘΕΡΜΑΝΣΗ	ΨΥΞΗ	ΘΕΡΜΑΝΣΗ		
ΑΠΟΔΟΣΗ	[kW]	8,50	10,00	8,50	10,00	8,50	10,00	8,50	10,00	9,50	10,80	9,50	10,80	9,50	10,80	9,50	10,80		
ΙΣΧΥΣ ΕΙΣΟΔΟΥ	[kW]	2,440	2,510	2,650	2,770	2,650	2,630	2,650	2,630	2,910	2,450	2,960	2,880	2,970	2,880	2,860	2,480		
ΡΕΥΜΑ	[A]	10,8	11,1	11,7	12,2	11,7	11,7	11,7	11,7	12,9	10,9	13,1	12,7	13,1	12,8	12,6	11,0		
ΜΕΓ. ΡΕΥΜΑ	[A]	22,6																	
ΒΑΘΜΟΣ ΕΝΕΡΓΙΑΚΗΣ ΑΠΟΔΟΣΗΣ/ ΣΥΝΤΕΛΕΣΤΗΣ ΑΠΟΔΟΣΗΣ	[kW/kW]	3,49	3,98	3,21	3,61	3,21	3,80	3,21	3,80	3,26	4,40	3,21	3,75	3,20	3,75	3,32	4,35		
ΔΙΑΣΤΑΣΕΙΣ (Υ×Π×Β)	ΕΞΩΤΕΡΙΚΗ ΜΟΝΑΔΑ [mm]	788 × 940 × 320																	
	ΕΞΩΤΕΡΙΚΗ ΜΟΝΑΔΑ (ΓΡΙΛΙΑ) [mm]	288 × 840 × 840 (53 × 950 × 950)		235 × 1390 × 705		270 × 1135 × 700		300 × 1000 × 700		288 × 840 × 840 (53 × 950 × 950)		235 × 1700 × 705		270 × 1135 × 700		300 × 1400 × 700			
ΒΑΡΟΣ	ΕΞΩΤΕΡΙΚΗ ΜΟΝΑΔΑ [kg]	52																	
	ΕΞΩΤΕΡΙΚΗ ΜΟΝΑΔΑ (ΓΡΙΛΙΑ) [kg]	26 (6,0)		31		38		36		29 (6,0)		38		38		46			
ΦΟΡΤΙΟ ΨΥΚΤΙΚΟΥ (Τόνοι εκπομπών ισοδύναμου CO ₂)	[kg] (t-CO ₂ eq)	1,90 (1,283)																	

- Για περισσότερες πληροφορίες, επισκεφθείτε την ιστοσελίδα: www.fujitsu-general.com
- Για αναζήτηση ανταλλακτικών, συμβουλευτείτε το κατάστημα από όπου προμηθευτήκατε το προϊόν.
- Επίπεδο ηχητικής πίεσης: λιγότερο από 70 dB(A) σύμφωνα με την οδηγία IEC 704-1.

ΕΥΡΟΣ ΛΕΙΤΟΥΡΓΙΑΣ	ΕΞΩΤΕΡΙΚΗ	ΕΞΩΤΕΡΙΚΗ	
ΨΥΞΗ/ΑΦΥΓΡΑΝΣΗ	[°C]	18 έως 32	-15 έως 46
ΘΕΡΜΑΝΣΗ	[°C]	16 έως 30	-15 έως 24
ΥΓΡΑΣΙΑ	[%]	80 ή λιγότερο	—

- Εάν το κλιματιστικό λειτουργεί υπό συνθήκες εκτός του επιτρεπόμενου εύρους θερμοκρασιών, το κλιματιστικό ενδέχεται να σταματήσει τη λειτουργία του λόγω ενεργοποίησης του αυτόματου κυκλώματος προστασίας.
- Ανάλογα με τις συνθήκες λειτουργίας, ο εναλλάκτης θερμότητας ενδέχεται να παγώσει στην κατάσταση λειτουργίας Ψύξης ή Αφύγρανσης και μπορεί να προκληθεί διαρροή νερού και άλλες ζημιές.
- Εάν η μονάδα χρησιμοποιείται για μεγάλες περιόδους υπό συνθήκες υψηλής υγρασίας, μπορεί να δημιουργηθεί υγρασία στην επιφάνεια της εσωτερικής μονάδας και να στάξει στο δάπεδο ή σε άλλα αντικείμενα από κάτω.

■ Εικόνα της επικέτας τεχνικών στοιχείων

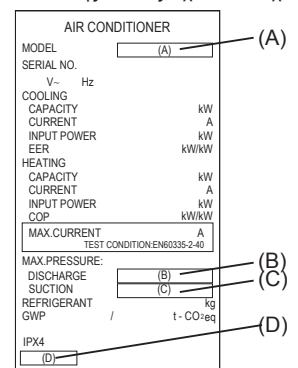

Ficha de informações do produto de acordo com o Regulamento Delegado (UE) 626/2011 da Comissão

MODELO	UNIDADE EXTERIOR	AOHG30KBTB								AOHG36KBTB							
	UNIDADE INTERIOR	AUXG30KRLB		ABHG30KRTA		ARXG30KMLA		ARXG30KHTAP		AUXG36KRLB		ABHG36KRTA		ARXG36KMLA		ARXG36KHTAP	
		ARREFECIMENTO	AQUECIMENTO	ARREFECIMENTO	AQUECIMENTO	ARREFECIMENTO	AQUECIMENTO	ARREFECIMENTO	AQUECIMENTO	ARREFECIMENTO	AQUECIMENTO	ARREFECIMENTO	AQUECIMENTO	ARREFECIMENTO	AQUECIMENTO	ARREFECIMENTO	AQUECIMENTO
NÍVEL DE POTÊNCIA ACÚSTICA	UNIDADE EXTERIOR [dB(A)]	68	69	68	69	68	69	68	69	70	70	70	70	70	70	70	70
	UNIDADE INTERIOR [dB(A)]	54	54	60	60	65	69	63	65	58	58	59	59	65	70	64	63
FLUIDO REFRIGERANTE/POTENCIAL DE AQUECIMENTO GLOBAL		R32 / 675 (IPCC AR4) ^(*)															
COEFICIENTE DE EFICIÊNCIA ENERGÉTICA SAZONAL/COEFICIENTE DE DESEMPENHO SAZONAL ^(*)		6,70	4,30	6,10	4,00	6,23	4,00	6,23	4,00	6,55	4,30	6,37	4,21	6,10	4,00	6,10	4,20
		—	—	—	—	—	—	—	—	—	—	—	—	—	—	—	—
CLASSE DE EFICIÊNCIA ENERGÉTICA ^(*)		A++	A+	A++	A+	A++	A+	A++	A+	A++	A+	A++	A+	A++	A+	A++	A+
		—	—	—	—	—	—	—	—	—	—	—	—	—	—	—	—
CONSUMO DE ENERGIA ANUAL (Q _{CE})(Q _{HE}) ^(*)		444 ^(*)	2601 ^(*)	486 ^(*)	2796 ^(*)	477 ^(*)	2797 ^(*)	477 ^(*)	2796 ^(*)	507 ^(*)	2828 ^(*)	524 ^(*)	2904 ^(*)	545 ^(*)	3044 ^(*)	544 ^(*)	2898 ^(*)
		—	—	—	—	—	—	—	—	—	—	—	—	—	—	—	—
P _{design} ^(*) (^(*))		8,50	8,00	8,50	8,00	8,50	8,00	8,50	8,00	9,50	8,70	9,50	8,70	9,50	8,70	9,50	8,70
		—	—	—	—	—	—	—	—	—	—	—	—	—	—	—	—
CAPACIDADE DE AQUECEDOR DE RESERVA/CAPACIDADE DECLARADA ^(*)		—	0,96/7,04	—	0,99/7,01	—	1,03/6,97	—	1,22/6,78	—	1,02/7,68	—	1,12/7,58	—	1,06/7,64	—	1,05/7,65
		—	—	—	—	—	—	—	—	—	—	—	—	—	—	—	—

NOTAS

- (*) A fuga de fluido refrigerante contribui para as alterações climáticas. Um fluido refrigerante com um potencial de aquecimento global (PAG) inferior contribui menos para o aquecimento global do que um fluido refrigerante com um PAG mais elevado, na eventualidade de ocorrer uma fuga para a atmosfera. Este aparelho contém um fluido refrigerante com um PAG equivalente a [675]. Isto significa que, se ocorresse uma fuga de 1 kg deste fluido refrigerante para a atmosfera, o impacto no aquecimento global seria [675] vezes superior ao de 1 kg de CO₂, durante um período de 100 anos. Nunca tente intervir sozinho no circuito refrigerante nem desmontar o produto pelos seus próprios meios e recorra sempre a um profissional.
- (*) Consumo de energia "Q_{CE}" kWh por ano com base em resultados de testes padrões. O consumo de energia real dependerá da forma como o aparelho for utilizado e da sua localização.
- (*) Consumo de energia "Q_{HE}" kWh por ano com base em resultados de testes padrões. O consumo de energia real dependerá da forma como o aparelho for utilizado e da sua localização.
- (*) Condição climática: A primeira linha é Média, a segunda linha é Mais Quente, e a terceira linha é Mais Fria.
- (*) Temperatura P_{design}: (ARREFECIMENTO) 35°C (AQUECIMENTO) Média: -10°C, Mais Quente: 2°C, Mais Frio: -22°C

Especificações

Os seguintes itens (A)-(D) são as informações apostas no equipamento de pressão de acordo com o Anexo I, Ponto 3.4b da Diretiva 2014/68/UE.

MODELO	(A)	UNIDADE EXTERIOR	AOHG30KBTB								AOHG36KBTB							
		UNIDADE INTERIOR	AUXG30KRLB	ABHG30KRTA	ARXG30KMLA	ARXG30KHTAP	AUXG36KRLB	ABHG36KRTA	ARXG36KMLA	ARXG36KHTAP								
TIPO			CASSETE	TECTO	CONDUTA				CASSETE	TECTO	CONDUTA							
PRESSÃO MÁXIMA	(B)	ALTA / DESCARGA [bar(MPa)]	42,0 (4,20)															
	(C)	BAIXA / SUCÇÃO [bar(MPa)]	27,6 (2,76)															
(D) DATA DE FABRICO			Consulte a etiqueta de classificação															
FONTE DE ALIMENTAÇÃO			1φ 230 V ~ 50 Hz															
			ARREFECIMENTO	AQUECIMENTO	ARREFECIMENTO	AQUECIMENTO	ARREFECIMENTO	AQUECIMENTO	ARREFECIMENTO	AQUECIMENTO	ARREFECIMENTO	AQUECIMENTO	ARREFECIMENTO	AQUECIMENTO	ARREFECIMENTO	AQUECIMENTO	ARREFECIMENTO	AQUECIMENTO
CAPACIDADE	[kW]		8,50	10,00	8,50	10,00	8,50	10,00	8,50	10,00	9,50	10,80	9,50	10,80	9,50	10,80	9,50	10,80
POTÊNCIA ABSORVIDA	[kW]		2,440	2,510	2,650	2,770	2,650	2,630	2,650	2,630	2,910	2,450	2,960	2,880	2,970	2,880	2,860	2,480
CORRENTE	[A]		10,8	11,1	11,7	12,2	11,7	11,7	11,7	11,7	12,9	10,9	13,1	12,7	13,1	12,8	12,6	11,0
CORRENTE MÁXIMA	[A]		22,6															
COEFICIENTE DE EFICIÊNCIA ENERGÉTICA/COEFICIENTE DE DESEMPENHO	[kW/kW]		3,49	3,98	3,21	3,61	3,21	3,80	3,21	3,80	3,26	4,40	3,21	3,75	3,20	3,75	3,32	4,35
DIMENSÕES (A x L x P)	UNIDADE EXTERIOR	[mm]	788 x 940 x 320															
	UNIDADE INTERIOR (GRELHA)	[mm]	288 x 840 x 840 (53 x 950 x 950)	235 x 1390 x 705	270 x 1135 x 700	300 x 1000 x 700	288 x 840 x 840 (53 x 950 x 950)	235 x 1700 x 705	270 x 1135 x 700	300 x 1400 x 700								
PESO	UNIDADE EXTERIOR	[kg]	52															
	UNIDADE INTERIOR (GRELHA)	[kg]	26 (6,0)	31	38	36	29 (6,0)	38	38	46								
CARGA DO FLUIDO REFRIGERANTE (Toneladas equivalentes de CO ₂)	[kg] (t-CO ₂ eq)		1,90 (1,283)															

- Para mais informações, visite o nosso sítio Web em: www.fujitsu-general.com
- Para consultas sobre peças de substituição, contacte a loja onde adquiriu o produto.
- Nível de pressão acústica: inferior a 70 dB(A) de acordo com a norma IEC 704-1.

GAMA DE FUNCIONAMENTO	INTERIOR	EXTERIOR
ARREFECIMENTO/DESUMIDIFICAÇÃO	[°C] 18 a 32	-15 a 46
AQUECIMENTO	[°C] 16 a 30	-15 a 24
HUMIDADE	[%] 80 ou menos	—

- Se o aparelho de ar condicionado for utilizado sob condições que não respeitem o intervalo de temperatura admissível, o aparelho de ar condicionado pode parar devido ao circuito de proteção automática.
- Dependendo das condições de funcionamento, o permutador de calor pode congelar durante o modo de arrefecimento ou desumidificação e pode provocar fuga de água e outros danos.
- Se a unidade for utilizada em condições de humidade elevada durante muito tempo, poderá formar-se condensação na superfície da unidade interior, resultando em pingas para o piso e outros objetos que se encontrem por baixo.

Imagem da etiqueta de classificação

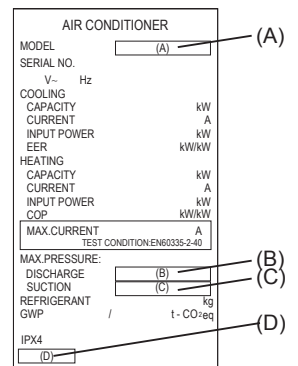

626/2011 Yetki Devrine Dayanan Komisyon Tüzüğü (AB) uyarınca ürün fişi

MODEL	DIŞ ÜNİTE		AOHG30KBTB								AOHG36KBTB							
	İÇ ÜNİTE		AUXG30KRLB		ABHG30KRTA		ARXG30KMLA		ARXG30KHTAP		AUXG36KRLB		ABHG36KRTA		ARXG36KMLA		ARXG36KHTAP	
			SOĞUTMA	ISITMA	SOĞUTMA	ISITMA	SOĞUTMA	ISITMA	SOĞUTMA	ISITMA	SOĞUTMA	ISITMA	SOĞUTMA	ISITMA	SOĞUTMA	ISITMA	SOĞUTMA	ISITMA
SES GÜCÜ DÜZEYİ	DIŞ ÜNİTE [dB(A)]		68	69	68	69	68	69	68	69	70	70	70	70	70	70	70	70
	İÇ ÜNİTE [dB(A)]		54	54	60	60	65	69	63	65	58	58	59	59	65	70	64	63
SOĞUTUCU/KÜRESEL ISINMA POTANSİYELİ			R32 / 675 (IPCC AR4) (*)															
MEVSİMLİK ENERJİ VERİMLİLİĞİ ORANI/ MEVSİMLİK PERFORMANS KATSAYISI (*)			6,70	4,30	6,10	4,00	6,23	4,00	6,23	4,00	6,55	4,30	6,37	4,21	6,10	4,00	6,10	4,20
ENERJİ VERİMLİLİĞİ SINIFI (*)			A++	A+	A++	A+	A++	A+	A++	A+	A++	A+	A++	A+	A++	A+	A++	A+
YILLIK ENERJİ TÜKETİMİ (Q _{CE})(Q _{HE}) (*)			444 (*)	2601 (*)	486 (*)	2796 (*)	477 (*)	2797 (*)	477 (*)	2796 (*)	507 (*)	2828 (*)	524 (*)	2904 (*)	545 (*)	3044 (*)	544 (*)	2898 (*)
Ptasarım (*)			8,50	8,00	8,50	8,00	8,50	8,00	8,50	8,00	9,50	8,70	9,50	8,70	9,50	8,70	9,50	8,70
YEDEK ISITICI KAPASİTESİ/ BİLDİRİLEN KAPASİTE (*)			—	0,96/7,04	—	0,99/7,01	—	1,03/6,97	—	1,22/6,78	—	1,02/7,68	—	1,12/7,58	—	1,06/7,64	—	1,05/7,65

NOTLAR

(*) Soğutucu sızıntısı iklim değişikliğini olumsuz etkiler. Daha düşük küresel ısınma potansiyeline (GWP) sahip soğutucu, atmosfere sızması durumunda, küresel ısınmayı, daha yüksek GWP'ye sahip bir soğutucudan daha az olumsuz etkiler. Bu cihaz, [675] değerine eşit GWP'li bir soğutucu sıvısı içerir. Bu, 1 kg soğutucu sıvısının atmosfere sızmasının, 100 yıllık bir süreç boyunca küresel ısınma üzerinde 1 kg CO₂'ten [675] kat daha fazla etkisi olacağı anlamına gelir. Kesinlikle kendi kendinize soğutucu devresine dokunmayı veya ürünü parçalarına ayırmayı denemeyin, her zaman bir uzmandan yardım isteyin.

(*) Standart test sonuçlarına göre yıllık enerji tüketimi "Q_{CE}" kWh. Asıl enerji tüketimi, cihazın nasıl kullanıldığına ve nerede konumlandırıldığına bağlı olacaktır.

(*) Standart test sonuçlarına göre yıllık enerji tüketimi "Q_{HE}" kWh. Asıl enerji tüketimi, cihazın nasıl kullanıldığına ve nerede konumlandırıldığına bağlı olacaktır.

(*) İklim koşulu: İlk satır Ortalama, ikinci satır Isıtıcı, üçüncü satır ise Soğutucu'dur.

(*) Ptasarım sıcaklığı: (SOĞUTMA) 35°C (ISITMA) Ortalama: -10°C, Isıtıcı: 2°C, Soğutucu: -22°C

Teknik özellikler

Aşağıdaki ögeler (A)-(D), 2014/68/EU Direktifinin Ek 1, 3.4b sayılı maddesi uyarınca basınçlı ekipmanlara ekli bilgilerdir.

MODEL	(A) DIŞ ÜNİTE		AOHG30KBTB								AOHG36KBTB							
	İÇ ÜNİTE		AUXG30KRLB		ABHG30KRTA		ARXG30KMLA		ARXG30KHTAP		AUXG36KRLB		ABHG36KRTA		ARXG36KMLA		ARXG36KHTAP	
TİP			KASET		TANAN		KANAL		KANAL		KASET		TANAN		KANAL		KANAL	
MAKS. BASINÇ	(B) YÜKSEK / BOŞALTIM [bar(MPa)]		42,0 (4,20)															
(C) DÜŞÜK / EMME [bar(MPa)]			27,6 (2,76)															
(D) ÜRETİM TARİHİ			Derece etiketine bakın															
GÜÇ KAYNAĞI			1φ 230 V ~ 50 Hz															
			SOĞUTMA	ISITMA	SOĞUTMA	ISITMA	SOĞUTMA	ISITMA	SOĞUTMA	ISITMA	SOĞUTMA	ISITMA	SOĞUTMA	ISITMA	SOĞUTMA	ISITMA	SOĞUTMA	ISITMA
KAPASİTE	[kW]		8,50	10,00	8,50	10,00	8,50	10,00	8,50	10,00	9,50	10,80	9,50	10,80	9,50	10,80	9,50	10,80
GÜÇ GİRİŞİ	[kW]		2,440	2,510	2,650	2,770	2,650	2,630	2,650	2,630	2,910	2,450	2,960	2,880	2,970	2,880	2,860	2,480
AKIM	[A]		10,8	11,1	11,7	12,2	11,7	11,7	11,7	11,7	12,9	10,9	13,1	12,7	13,1	12,8	12,6	11,0
MAKSİMUM AKIM	[A]		22,6															
ENERJİ VERİMLİLİĞİ ORANI/ PERFORMANS KATSAYISI	[kW/kW]		3,49	3,98	3,21	3,61	3,21	3,80	3,21	3,80	3,26	4,40	3,21	3,75	3,20	3,75	3,32	4,35
BOYUT (Y×G×D)	DIŞ ÜNİTE [mm]		788 × 940 × 320															
	İÇ ÜNİTE (İZGARA) [mm]		288 × 840 × 840 (53 × 950 × 950)	235 × 1390 × 705	270 × 1135 × 700	300 × 1000 × 700	288 × 840 × 840 (53 × 950 × 950)	235 × 1700 × 705	270 × 1135 × 700	300 × 1400 × 700								
AĞIRLIK	DIŞ ÜNİTE [kg]		52															
	İÇ ÜNİTE (İZGARA) [kg]		26 (6,0)	31	38	36	29 (6,0)	38	38	46								
SOĞUTUCU DOLUMU (CO ₂ ton eşdeğer)	[kg] (t-CO ₂ e)		1,90 (1,283)															

- Daha fazla bilgi için www.fujitsu-general.com adresindeki sitemizi ziyaret edin
- Yedek parça sorguları için, ürünü satın aldığınız mağazaya danışın.
- Ses basıncı düzeyi : IEC 704-1'e göre 70 dB(A) değerinden az.

ÇALIŞMA ARALIĞI	İÇ	DIŞ
SOĞUTMA/KURUTMA	[°C] 18 - 32	-15 - 46
ISITMA	[°C] 16 - 30	-15 - 24
NEM	[%] 80 veya daha az	—

- Klima izin verilen sıcaklık aralığı koşullarının altında çalışıyorsa otomatik koruma devresi devreye girdiğinden klima durabilir.
- Kullanım koşullarına bağlı olarak ısı eşanjörü Soğutma veya Kuru modu sırasında donabilir ve su sızıntısına veya başka bir hasara neden olabilir.
- Ünite uzun süre yüksek nem içeren koşullar altında kullanılırsa iç ünitenin yüzeyinde yoğunlaşma meydana gelebilir ve zemine veya iç ünitenin altındaki diğer nesnelere damlayabilir.

Derece etiketi görüntüsü

AIR CONDITIONER	
MODEL SERIAL NO.	(A)
V- Hz	
COOLING CAPACITY	kW
CURRENT	A
INPUT POWER	kW
EER	kW/kW
HEATING CAPACITY	kW
CURRENT	A
INPUT POWER	kW
COP	kW/kW
MAX. CURRENT	A
TEST CONDITION EN60335-2-40	
MAX. PRESSURE:	
DISCHARGE	(B)
SUCTION	(C)
REFRIGERANT	kg
GWP	t-CO ₂ e
IPX4	(D)