

# OPERATION MANUAL

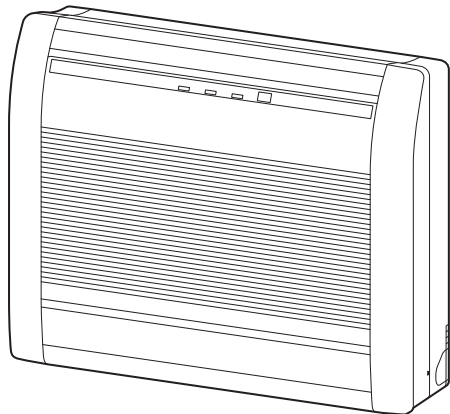

## MODEL:

- \* Please write down the model name.  
(Refer to the rating label.)
- \* Bitte schreiben Sie den Modellnamen auf.  
(Siehe Typenschild)
- \* Veuillez écrire le nom du modèle.  
(Consultez l'étiquette des spécifications.)
- \* Anote el nombre de modelo.  
(Consulte la etiqueta de calificación).
- \* Annotare il nome del modello.  
(Fare riferimento all'etichetta delle specifiche).
- \* Καταγράψτε το όνομα μοντέλου.  
(Ανατρέξτε στην ετικέτα τεχνικών στοιχείων.)
- \* Registe o nome de modelo.  
(Consulte a etiqueta de classificação.)
- \* Запишите название модели.  
(См. на паспортной табличке.)
- \* Lütfen model adını not ediniz.  
(Derece etiketine bakınız.)

## OPERATION MANUAL AIR CONDITIONER (Floor type)

Before using this product, read these instructions thoroughly and keep this manual for future reference.

## BEDIENUNGSANLEITUNG KLIMAANLAGE (Boden Typ)

Bevor Sie dieses Produkt verwenden, lesen Sie diese Anweisungen sorgfältig durch und bewahren Sie diese Anleitung für späteres Nachschlagen auf.

## MODE D'EMPLOI CLIMATISEUR (Type à sol)

Avant d'utiliser ce produit, veuillez lire attentivement ces instructions. Conservez ce manuel pour référence future.

## MANUAL DE FUNCIONAMIENTO ACONDICIONADOR DE AIRE (Tipo suelo)

Antes de utilizar el producto, lea estas instrucciones detenidamente y conserve este manual para consultarlo en el futuro.

## MANUALE DI ISTRUZIONI CONDIZIONATORE D'ARIA (Tipo da pavimento)

Prima di utilizzare l'apparecchio, leggere attentamente le presenti istruzioni e conservare il manuale per poterlo consultare il futuro.

## ΕΓΧΕΙΡΙΔΙΟ ΛΕΙΤΟΥΡΓΙΑΣ ΚΛΙΜΑΤΙΣΤΙΚΟ (Επιδαπέδιου τύπου)

Προτού χρησιμοποιήσετε το προϊόν, διαβάστε προσεκτικά τις παρούσες οδηγίες και φυλάξτε το παρόν εγχειρίδιο, ώστε να μπορείτε να ανατρέχετε σε αυτό στο μέλλον.

## MANUAL DE FUNCIONAMENTO AR CONDICIONADO (Tipo de chão)

Antes de utilizar este produto, leia atentamente estas instruções e guarde este manual para referência futura.

## РУКОВОДСТВО ПО ЭКСПЛУАТАЦИИ КОНДИЦИОНЕР ВОЗДУХА (Напольный тип)

Перед эксплуатацией устройства внимательно ознакомьтесь с данным руководством и сохраняйте его для использования в будущем.

## KULLANIM KILAVUZU KLİMA (Zemin tipi)

Bu ürünü kullanmadan önce verilen talimatları dikkatlice okuyun ve daha sonra tekrar faydalanmak üzere saklayın.

English

Deutsch

Français

Español

Italiano

Ελληνικά

Português

Русский

Türkçe



PART No. 9378532090-02





# Contents

- 1. SAFETY PRECAUTIONS..... 1
- 2. PREPARATION..... 2
- 3. NAME OF PARTS ..... 3
  - 3.1. Indoor unit ..... 3
  - 3.2. Remote controller ..... 3
  - 3.3. Inserting batteries..... 5
- 4. BASIC OPERATIONS ..... 5
- 5. AIRFLOW SETTINGS ..... 5
  - 5.1. Fan speed setting..... 5
  - 5.2. Airflow direction setting ..... 6
- 6. TIMER OPERATIONS ..... 6
  - 6.1. Weekly timer..... 7
  - 6.2. On timer or Off timer..... 7
  - 6.3. Program timer..... 7
  - 6.4. Sleep timer ..... 7
- 7. ENERGY SAVING OPERATION..... 8
  - 7.1. Economy operation ..... 8
- 8. OTHER OPERATIONS ..... 8
  - 8.1. Powerful operation ..... 8
  - 8.2. Outdoor Unit Low Noise operation ..... 8
  - 8.3. 10 °C Heat operation..... 8
- 9. SETTINGS ON INSTALLATION..... 8
  - 9.1. Remote controller custom code setting ..... 8
- 10. CLEANING AND CARE..... 9
- 11. GENERAL INFORMATION ..... 10
- 12. OPTIONAL PARTS ..... 11
  - 12.1. Wired remote controller ..... 11
  - 12.2. Multi-split type air conditioner..... 11
- 13. TROUBLESHOOTING ..... 11

## 1. SAFETY PRECAUTIONS



To prevent personal injury or property damage, read this section carefully before you use this product, and be sure to comply with the following safety precautions.

Incorrect operation due to failure to follow the instructions may cause harm or damage, the seriousness of which is classified as follows:

 <b>WARNING</b>
<b>This mark warns of death or serious injury.</b>
 <b>CAUTION</b>
<b>This mark warns of injury or damage to property.</b>
 This mark denotes an action that is PROHIBITED.
 This mark denotes an action that is COMPULSORY.

Explanation of symbols displayed on the indoor unit or outdoor unit.

 <b>WARNING</b>
This symbol shows that this product uses a flammable refrigerant. If the refrigerant is leaked and exposed to an external ignition source, there is a risk of fire.

 <b>CAUTION</b>
This symbol shows that the operation manual should be read carefully.
 <b>CAUTION</b>
This symbol shows that a service personnel should be handling this equipment with reference to the installation manual.
 <b>CAUTION</b>
This symbol shows that information is available such as the operation manual or installation manual.

## **WARNING**

-  • The appliance shall be installed, operated and stored in a room with a floor area larger than X m<sup>2</sup>.

Amount of refrigerant charge M (kg)	Minimum room area X (m <sup>2</sup> )
$M \leq 1.22$	-
$1.22 < M \leq 1.23$	12.99
$1.23 < M \leq 1.50$	19.31
$1.50 < M \leq 1.75$	26.28
$1.75 < M \leq 2.0$	34.33
$2.0 < M \leq 2.5$	53.63
$2.5 < M \leq 3.0$	77.23
$3.0 < M \leq 3.5$	105.12
$3.5 < M \leq 4.0$	137.29

(IEC 60335-2-40)

- This product contains no user-serviceable parts. Always consult authorized service personnel for repairing, installation, and relocation of this product. Improper installation or handling will cause leakage, electric shock, or fire.
- In the event of a malfunction such as burning smell, immediately stop operation of the air conditioner, and disconnect all the power supply by turning off the electrical breaker or disconnecting the power plug. Then consult authorized service personnel.
- Take care not to damage the power supply cable. If it is damaged, it should be replaced only by authorized service personnel in order to avoid a hazard.
- In the event of refrigerant leakage, be sure to keep away from fire or any flammables, and consult authorized service personnel.
- In the event of a thunder storm or any prior sign of a lightning strike, turn off the air conditioner via the remote controller, and refrain from touching the product or the power source to prevent any electrical hazards.
- This product shall be stored in a room without continuously operating ignition sources (for example: open flames, an operating gas appliance or an operating electric heater).
- This product shall be stored in a well-ventilated area.
- Be aware that refrigerants may not contain an odour.
- This product shall be stored so as to prevent mechanical damage from occurring.
- Disposing of the product shall be done properly, in compliance with national or regional regulations.
- During transportation or relocation of the indoor unit, pipes shall be covered with the wall hook bracket for protection.  
Do not move this product by holding the indoor unit pipes. (The stress applied to the pipe joints may cause the flammable gas to leak during operation).

### ! WARNING

- ! This product is not intended for use by persons (including children) with reduced physical, sensory or mental capabilities, or lack of experience and knowledge, unless they have been given supervision or instruction concerning use of this product by a person responsible for their safety. Children should be supervised to ensure that they do not play with this product.
- Dispose of the packing materials safely. Tear and dispose of the plastic packing bags so that children cannot play with them. There is danger of suffocation if children play with the original plastic bags.
- ⊘ Do not install the unit in area filled with mineral oil such as a factory or area containing a large amount of splashed oil or steam such as a kitchen.
- Do not start or stop the operation of this product by inserting or pulling out the power plug, or by turning on or off the circuit breaker.
- Do not use flammable gases near this product.
- Do not expose yourself directly to the cooling airflow for many hours.
- Do not insert your fingers or any other objects into outlet port or inlet port.
- Do not operate with wet hands.
- Do not use means to accelerate the defrosting process or to clean this product, other than those recommended by the manufacturer.
- Do not pierce or burn.

### ! CAUTION

- ! Provide occasional ventilation during use.
- Always operate this product with air filters installed.
- Ensure that any electronic equipment is at least 1 m (40 in) away from this product.
- Disconnect all the power supply when not using this product for extended periods.
- After a long period of use, ensure to get the mounting of the indoor unit checked to prevent this product from falling down.
- The airflow direction and the room temperature should be carefully considered when you use this product in a room with infants, children, elderly or sick persons.
- Keep the surroundings of the outdoor unit clean and tidy, and do not place items around it. Any objects blocking or entering from the outlet ports may cause product malfunction.
- ⊘ Do not direct the airflow at fireplaces or heating apparatus.
- Do not block or cover the intake grille and the outlet port.
- Do not apply any heavy pressure to radiator fins.
- Do not climb on, place objects on, or hang objects from this product.
- Do not place any other electrical products or household belongings under this product. Dripping condensation from this product might get them wet, and may cause damage or malfunction of your property.
- Do not expose this product directly to water.
- Do not use this product for preservation of food, plants, animals, precision equipment, art work, or other objects. This may cause quality deterioration of those items.
- Do not expose animals or plants to the direct airflow.
- Do not drink the drainage from the air conditioner.
- Do not pull the power supply cable.

### ! CAUTION

- ⊘ Do not touch the aluminum fins of heat exchanger built-in this product to avoid personal injury when you maintain the unit.
- Do not stand on unstable steps when operating or cleaning this product. It may overturn and can cause injury.
- Do not use flammable substances (such as pesticides and hair sprays). Doing so may cause an electric shock, fire or wrong detection by the refrigerant sensor.
- This product is equipped with a refrigerant leakage sensor. Do not install the product at a location filled with smoke, gases or chemicals.
- Do not turn off the breaker unless the product is under repair, inspection, or cleaning. Otherwise, the sensor is unable to detect refrigerant leak.

This product contains fluorinated greenhouse gases.

## 2. PREPARATION

### ! WARNING

- ! Take care to prevent infants and young children from accidentally swallowing the batteries.

### ! CAUTION

- ! If leaking battery fluid comes in contact with your skin, eyes, or mouth, immediately rinse with plenty of clean water, and consult your physician.
- Exhausted batteries must be removed immediately, and be disposed according to the local laws and regulations of your region.
- ⊘ Do not attempt to recharge dry batteries.
- Do not use dry batteries that has been recharged.

#### Indoor unit accessories

Please check that the following accessories are included.

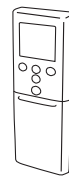

Remote controller

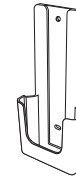

Remote controller holder



Self-tapping screws

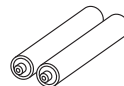

Batteries

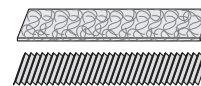

Air cleaning filters

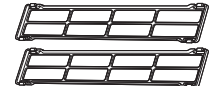

Filter holders

#### Remote controller holder installation

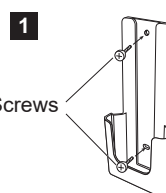

1

Screws

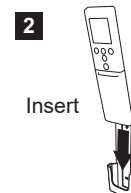

2

Insert

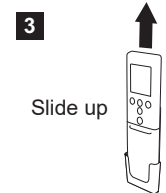

3

Slide up

### 3. NAME OF PARTS

#### CAUTION

For appropriate signal transmission between the remote controller and the indoor unit, keep the signal receiver away from the following items:

- Direct sunlight or other strong lights
- Flat-panel television screen

In rooms with instantaneous fluorescent lights, such as inverter type ones, the signal may not be transmitted properly. In such a case, consult the store of purchase.

#### 3.1. Indoor unit

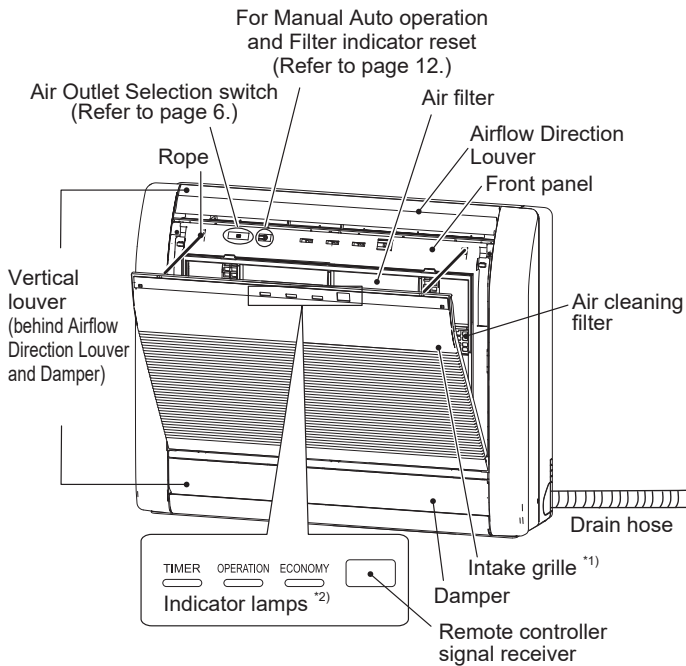

\*1) Before starting operation, make sure that the intake grille is closed completely. Incomplete closing may affect the proper function or performance of the product.

\*2) Indicator lamps light in the following conditions. It cannot see when the indicator lamp is off.

Name	Color	Operation or condition
TIMER	Orange	Timer operation
OPERATION	Green	Normal operation
ECONOMY	Green	Economy operation 10 °C Heat operation

#### 3.2. Remote controller

When you use the optional remote controller, the appearance and the operation procedure may differ. For details, please refer to the operation manual of each remote controller.

\* : The setting must be done while the setting screen is displayed for each function.

| : The button is controllable only when the air conditioner is operating.

#### Remote controller display

In this section, all the possible indicators are displayed for description. In actual operation, the display is linked with the button operation, and only shows the necessary indicators for each setting.

#### For Basic operations ..... Refer to page 5.

Starts or stops the air conditioner operation.

**MODE** Changes the operation mode. \*|

TEMP.  
 Adjusts the setting temperature. \*|

#### For 10 °C Heat operation ..... Refer to page 8.

Activates the 10 °C Heat operation.

#### For Energy saving operation ..... Refer to page 8.

Activates or deactivates the Economy operation. |

#### For Outdoor Unit Low Noise operation ... Refer to page 8.

Activates or deactivates the Outdoor Unit Low Noise operation.

Do not press this button in normal use. It starts the test run (for use by authorized service personnel only).  
**NOTES:** If the test run starts unintentionally, press to quit the test run.

## CAUTION

- To prevent malfunction or damage of the remote controller:
  - Place remote controller at where will not be exposed to direct sunlight or excessive heat.
  - Remove batteries if the product is not going to be used for an extended period.
- Obstacles such as a curtain or wall between the remote controller and the indoor unit may affect the appropriate signal transmission.
- Do not apply strong shocks to the remote controller.
- Do not pour water on the remote controller.

### Signal transmitter

- Aim at the signal receiver of the indoor unit properly.
- Operating range is approximately 7 m.
  - [▲] will appear when the signal is transmitted.
  - The indoor unit will emit a beep when it receive the signal properly. If there is no beep, press the button again.

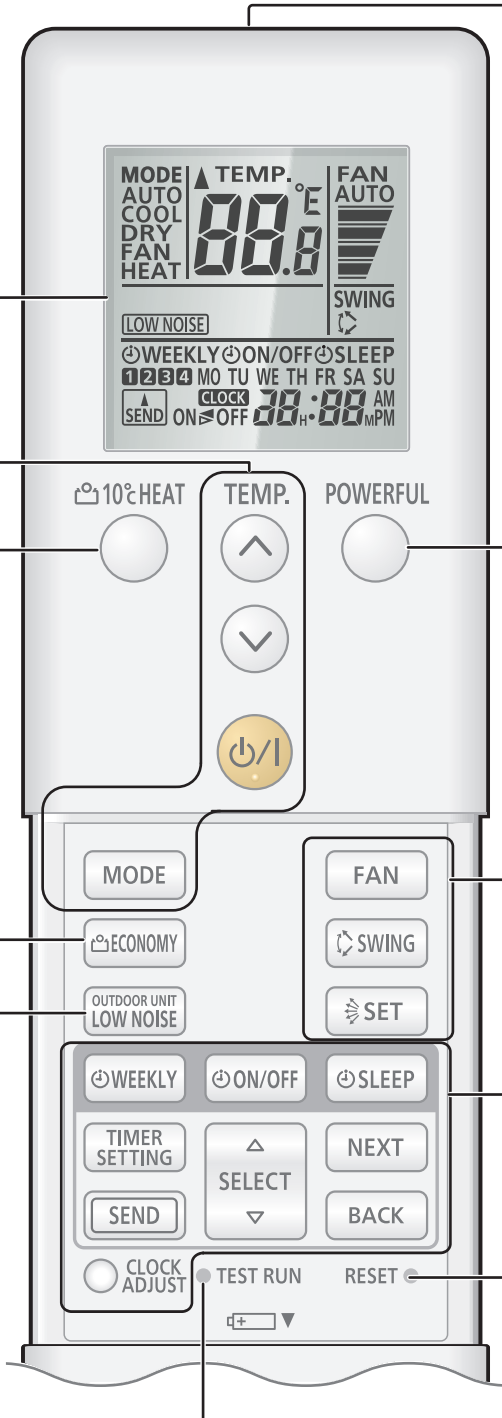

### For Powerful operation ..... Refer to page 8.

**POWERFUL** Activates or deactivates the Powerful operation. |

### For Airflow settings ..... Refer to page 5.

**FAN** Controls the fan speed. \*|

**SWING** Sets the automatic Swing operation. \*|

**SET** Controls the up and down airflow direction. |

### For Timer operations ..... Refer to page 5.

**WEEKLY** Activates or deactivates the Weekly timer.

**ON/OFF** Activates or deactivates the On timer, Off timer, or Program timer.

**SLEEP** Activates or deactivates the Sleep timer.

**TIMER SETTING** Starts the timer setting.

**SEND** Sends the timer or clock setting to the indoor unit. \*

**NEXT** Forwards the timer or clock setting to the next step.

**BACK** Returns the timer or clock setting to the previous step.

**SELECT** Adjusts the value of the timer or clock settings.

**CLOCK ADJUST** Starts the clock setting.

### After replacing batteries

**RESET** Press this button as shown in the following figure. Use a tip of a ballpoint pen or other small object.



### 3.3. Inserting batteries

Battery type: R03/LR03/AAA x 2

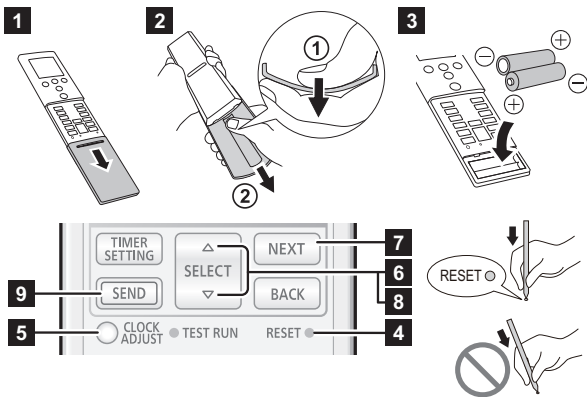

- 1** Pull the cover in the direction of the arrow and open it until it is trapped.
- 2** Remove the cover.
  - ① Turn the remote controller over and push the back side of the cover and remove the claws by curving the cover.
  - ② Pull in the direction of the arrow while curving the cover.
- 3** Put batteries as shown in the figure above.
- 4** Press RESET○ as shown in the figure above. Use the tip of a ballpoint pen or other small object.
- 5** Press **CLOCK ADJUST** to start setting day of the week and clock.
- 6** Press **SELECT** (△▽) to set day of the week (Monday to Sunday).
- 7** Press **NEXT** to continue.
- 8** Press **SELECT** (△▽) to set the clock. Press the buttons to change the clock by a minute. Press and hold the buttons to change the clock by 10 minutes.
  - \* To switch the time indicator (12-hour ⇄ 24-hour), press **TEMP.** (⊕⊖).
- 9** Press **SEND** to complete the setting. Be close to the indoor unit. If you press the button from a distance, settings may not be properly sent.
- 10** Install and close the cover.

#### NOTES:

- Use specified type of batteries only.
- Do not mix different types or new and used batteries together.
- Batteries can be used about 1 year in ordinary use.
- If the remote control range noticeably shortens, replace the batteries, and press RESET○ as shown in the figure above.

## 4. BASIC OPERATIONS

### 3 steps to start operation

1. Press **(ON/OFF)** to start or stop the operation.
2. Press **MODE** to select the operation mode. The operation mode changes as follows.
 

AUTO → COOL → DRY → FAN → HEAT
3. Press **TEMP.** (⊕⊖) to set the desired temperature. The temperature changes by 0.5 °C increments.

Temperature setting range	
Auto/Cooling/Dry	18.0 to 30.0 °C
Heating	16.0 to 30.0 °C

#### NOTES:

- In the Cooling or Dry mode, set the temperature lower than the current room temperature.
- In the Cooling mode, the indoor unit fan may stop from time to time to perform Fan control for energy saving that enables power-saving operation by stopping the rotation of the indoor unit fan when the outdoor unit is stopped. In initial setting, this function is activated. To deactivate the function, consult the installer or authorized service personnel.
- In the Heating mode,
  - set the temperature higher than the current room temperature.
  - at the beginning of the operation, the indoor unit fan rotates at very low speed for 3-5 minutes.
  - the Automatic defrosting operation overrides the Heating operation when necessary.
- In the Fan mode, temperature control is not available.

### Temperature unit switching

1. Press **(ON/OFF)** until only the clock is displayed.
2. Press down **TEMP.** (⊕) for more than 5 seconds. The current temperature unit will be displayed. (Factory setting: °C)
3. Press **TEMP.** (⊕⊖) to switch the temperature unit. (°C ⇄ °F)
4. Press **(ON/OFF)** to finish the setting. If you do not press the button for 30 seconds, the displayed temperature unit will be set.

## 5. AIRFLOW SETTINGS

### 5.1. Fan speed setting

- ✎ Press **FAN** to control the fan speed.

The fan speed changes as follows.



When **AUTO** is selected, the fan speed depends on the operating condition.

To increase the air cleaning effect, set the fan speed to High.

## 5.2. Airflow direction setting

For details of the airflow ranges, refer to “Airflow direction range”.

### ■ Up and down airflow direction setting

Press **SET** to adjust the Up and down airflow direction.

### ■ Left and right airflow direction setting

#### ⚠ CAUTION

Before you adjust the left and right airflow direction, make sure that the up and down airflow direction louver has been stopped completely.

Adjust two knobs by hand.

### ■ Swing operation setting

Press **SWING** to start/stop the Swing operation.

**NOTES:** The Swing operation may stop temporarily when the indoor unit fan is rotating at very low speed or is stopped.

### ■ Airflow direction range

Up and down airflow direction

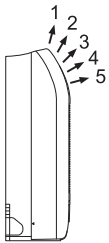

Change by <b>SET</b>	1 ↻ 2 ↻ 3 ↻ 4 ↻ 5
Swing operation by <b>SWING</b>	1 ← → 5

#### NOTES:

- Do not adjust the airflow direction louvers by hand.
- In the Auto or Heating mode, the airflow direction stay position 1 for a while from the start of the operation.
- When indoor unit is embedded in a wall, airflow is fixed to horizontal direction 5. Please ask the service personnel to perform the embedding in a wall.

### ■ Vertical louver Adjustment

Adjust the vertical louver.

Move the vertical louver to adjust airflow in the direction you prefer.

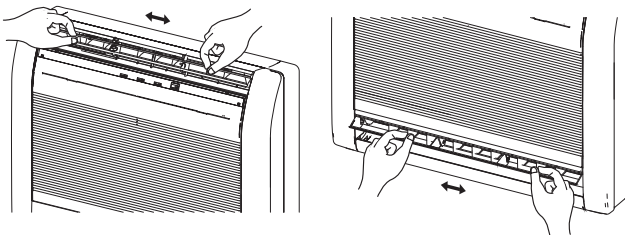

#### ⚠ CAUTION

Always adjust the vertical louver when the damper is open. Opening the damper forcibly with hands can cause damper to malfunction.

### ■ Air outlet selection

With this function, air come out simultaneously from the upper and lower air outlets so that the room can be cooled or heated effectively. This function is set using the switch behind the front grille of the Indoor unit. (This function is available in cooling and heating operation.)

- How to set to blow out air from the upper and lower air outlets.

Air Outlet Selection switch	
Upper airflow	Upper and lower airflow
←	→

#### NOTES:

- Set the air outlet selection switch to the end. Otherwise, air outlet cannot be selected as intended.

#### Description of operation

Operation Mode	Airflow	Conditions
Cooling	Upper and lower airflow	Room temperature and set temperature are different.
	Upper airflow	Room temperature is close to set temperature, or the air conditioner has operated for 1 hour.
Dry	Upper and lower airflow	-
Heating	Upper and lower airflow	Airflow temperature is high
	Upper airflow	Airflow temperature is low. (During defrosting operation, start of operation, etc.)

## 6. TIMER OPERATIONS

**NOTES:** When [ **TIMER** ] indicator on the indoor unit blinks, set the clock and timer again. This blinking shows that the internal clock go wrong due to an interruption of the power supply. (Refer to page 10.)

### ■ Timer setting procedure

Before setting the timer, please adjust the clock. (Refer to “remote controller preparation”).

- Press **TIMER SETTING**.  
ⓄWEEKLY on the remote controller display will blink.
- Press **SELECT** (△▽) to choose timer operation.  
The timer operation will change as follows:

ⓄWEEKLY	Weekly timer	Enables you to set operation schedules up to 4 setting for each day of the week.
ⓄON/OFF [ ON ]	On timer	Starts the operation at your desired time.
ⓄON/OFF [ OFF ]	Off timer	Stops the operation at your desired time.
ⓄON/OFF [ ON≠OFF ]	Program timer	Operates as the combination of the On timer and Off timer.
ⓄSLEEP	Sleep timer	Supports your comfortable sleep by moderating the air conditioner operation gradually.

- Press **NEXT**.
- Set each timer operation.  
For details, refer to the following instructions of each timer setting.
- Press **SEND** to complete the timer setting.  
Be close to the indoor unit.

- To cancel the timer setting during the procedure, press **TIMER SETTING** again.

## 6.1. Weekly timer

### Setting details

- Select Weekly timer in step 2 of "Timer setting procedure".
- Press **SELECT** ( $\Delta \nabla$ ) to select the program number and the day of the week.  
Selected program number (1~4) and the day of the week will blink.

MO	Monday
TU	Tuesday
WE	Wednesday
TH	Thursday
FR	Friday
SA	Saturday
SU	Sunday

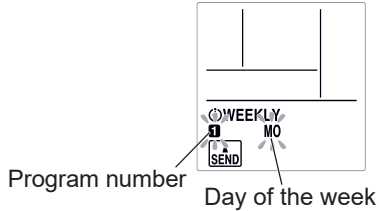

- Press **NEXT**.
- Press **SELECT** ( $\Delta \nabla$ ) to choose the timer operation.

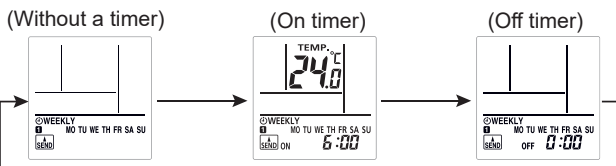

- Press **NEXT**.  
\* When you chose "Without a timer" in step 4, the setting display will return to step 1.
- Press **SELECT** ( $\Delta \nabla$ ) to set on time or off time.
- Press **NEXT**.  
\* When you chose "Off timer" in step 4, the setting display will return to step 1.
- Press **SELECT** ( $\Delta \nabla$ ) to set the temperature.

#### Temperature setting range

Auto, Cooling, or	18.0 to 30.0 °C
Dry mode:	*Even if you set to 10.0, 16.0-17.5 °C, the air conditioner will run at 18.0 °C.
Heating mode:	10.0 or 16.0 to 30.0 °C

- Press **NEXT**.  
The setting display will return to step 1.
- Press **SEND** to complete the setting.  
Be close to the indoor unit.  
**NOTES:** [  $\text{TIMER}$  ] indicator on the indoor unit will not turn on even if the setting is complete.

- If you want to return the previous step, press **BACK**.
- To check the schedule, use **SELECT** ( $\Delta \nabla$ ) to browse the Weekly timer settings in step 1.  
To finish checking, press **TIMER SETTING**.
- To deactivate the Weekly timer, press **WEEKLY** while  $\text{WEEKLY}$  is shown on the remote controller display.  
The indicator will disappear.

#### NOTES:

- The operation modes will be the same as the mode at the last time operation was stopped, so Cooling  $\rightarrow$  Heating  $\rightarrow$  Cooling  $\rightarrow$  Heating type of operations cannot be set automatically.
- If you set the On timer and Off timer on the same time, the On timer will work.
- If two On timers are set on the same time, the air conditioner will run in the order of the program number.
- You cannot the Weekly timer and the other timers simultaneously. If you use the On/Off timer, the Program timer, or the Sleep timer while the Weekly timer is activated, the Weekly timer will be deactivated.  
In such a case, activate the Weekly timer after the other timer finishes.
- If the wired remote controller (optional) is connected, this function is restricted.

## Examples of Weekly timer

### Example 1

	7:00	9:00	11:00	17:00	23:00
Monday to Friday	Program 1 On 26 °C Wake up	Program 2 Off Leave for work		Program 3 On 28 °C Come back home	Program 4 Off Go to sleep
Saturday	(No timer settings)				
Sunday	(On)	Program 1 Off (On)	Program 2 Off (On)	Program 3 Off (On)	Program 4 Off (On)

Example 2: You can specify temperature settings using the On timer in the Weekly timer.

	7:00	9:00	17:00	23:00
Program 1	Program 2	Program 3	Program 4	
On 28 °C	On 26 °C	On 27 °C	On 28 °C	

## 6.2. On timer or Off timer

- Select On timer or Off timer in step 2 of "Timer setting procedure".
  - Press **SELECT** ( $\Delta \nabla$ ) to set on time or off time.  
Pressing the button: The time will change by +5/-5 minutes.  
Pressing down the button: The time will change by +10/-10 minutes.
- To deactivate the On/Off timer, press **ON/OFF** while  $\text{ON/OFF}$  is shown on the remote controller display.  
The indicator will disappear.

## 6.3. Program timer

- Set On timer and Off timer. (Refer to "6.2. On timer or Off timer").
- Select Program timer in step 2 of "Timer setting procedure".  
The timer whose setting time is closer to the current time works first. The order of the timer operation is displayed as follows:

Timer	Indicator on the remote controller display
On $\rightarrow$ Off timer	<b>ON <math>\triangleright</math> OFF</b>
Off $\rightarrow$ On timer	<b>ON <math>\triangleleft</math> OFF</b>

**NOTES:** You can set the Program timer only within a span of 24 hours.

## 6.4. Sleep timer

- Select Sleep timer in step 2 of "Timer setting procedure".
- Press **SELECT** ( $\Delta \nabla$ ) to set the time until the operation stops.

Each time you press the button, the time changes as follows:

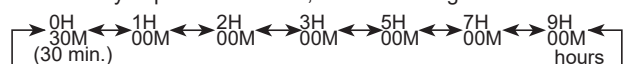

- To deactivate the Sleep timer, press **SLEEP** while  $\text{SLEEP}$  is shown on the remote controller display.  
The indicator will disappear.

During the Sleep timer operation, the setting temperature changes as the following figure.

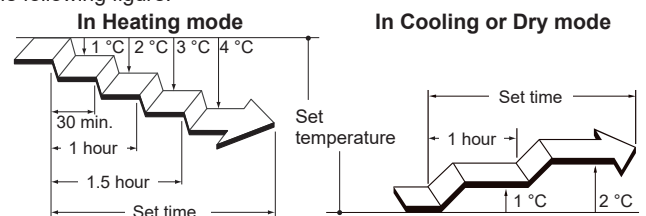

After the set time has elapsed, the air conditioner operation turns off.



## 7. ENERGY SAVING OPERATION

### 7.1. Economy operation

It saves more electricity than other operation modes by changing the set temperature to a moderate setting.

Press **ECONOMY** to activate/deactivate the Economy operation.

[ **OPERATION** **ECONOMY** ] indicator on the indoor unit will turn on.

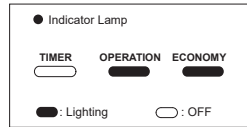

Operation mode	Room temperature
Cooling/Dry	Few degrees higher than the set temperature
Heating	Few degrees lower than the set temperature

#### NOTES:

- In the Cooling, Heating, or Dry mode, the maximum output of this operation is approximately 70 % of usual operation.
- This operation cannot be performed during the temperature monitoring by the Auto mode.

## 8. OTHER OPERATIONS

### 8.1. Powerful operation

In the Powerful operation, the air conditioner will operate at maximum power and strong airflow to cool down or warm up the room quickly.

**NOTES:** In multi connection, this function cannot be used.

Press **POWERFUL** to activate/deactivate the Powerful operation. When activated, the indoor unit will emit 2 short beeps. When deactivated, the indoor unit will emit 1 short beep.

The Powerful operation will be turned off automatically in the following situations:

- The Powerful operation runs for a certain amount of time and the room temperature reaches the set temperature in the Cooling, Dry, or Heating mode.
- 20 minutes after the Powerful operation has started.

#### NOTES:

- The airflow direction and the fan speed are controlled automatically.
- The Powerful operation cannot be performed simultaneously with Economy operation.
- The Powerful operation overrides the following operations. If the following operations are set, they will start after the Powerful operation finishes.
  - Outdoor Unit Low Noise operation
  - Energy Saving program
- If the wired remote controller (optional) is connected, this function is restricted.

### 8.2. Outdoor Unit Low Noise operation

The Outdoor Unit Low Noise operation lowers noise from the outdoor unit. During this operation, the rotation number of the compressor decreases and the outdoor unit fan rotates slowly.

**NOTES:** In multi connection, this function cannot be used.

Press **OUTDOOR UNIT LOW NOISE** to activate/deactivate the Outdoor Unit Low Noise operation.

While the Outdoor Unit Low Noise operation is activated, **LOW NOISE** on the remote controller is displayed.

The setting is preserved even if the air conditioner is turned off.

#### NOTES:

- This operation cannot be performed simultaneously with the Fan mode, Dry mode, and Powerful operation.
- If the wired remote controller (optional) is connected, this function is restricted.

### 8.3. 10 °C Heat operation

10 °C Heat operation maintains the room temperature at 10 °C so as to prevent the room temperature to drop too low.

Press **10°C HEAT** to activate the 10 °C Heat operation.

The indoor unit will emit 1 short beep and [ **ECONOMY** ] indicator on the indoor unit will turn on.

Press **(b/|)** to turn off the air conditioner.

[ **ECONOMY** ] indicator will turn off.

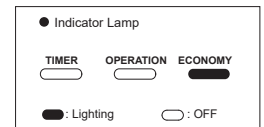

#### NOTES:

- During the 10 °C Heat operation, only **SET** is valid.
- When the room temperature is warm enough, this operation will not perform.
- If the wired remote controller (optional) is connected, this function is restricted.

## 9. SETTINGS ON INSTALLATION

### 9.1. Remote controller custom code setting

By setting custom code of indoor unit and remote controller, you can specify the air conditioner which the remote controller controls.

When two or more air conditioners are in the room and you wish to operate them separately, set the custom code (4 selections possible).

**NOTES:** If custom codes is different between the indoor unit and the remote controller, the indoor unit cannot receive a signal from the remote controller.

#### How to set the remote controller custom code

- Press **(b/|)** until only the clock is displayed on the remote controller display.
- Press and hold **(MODE)** for more than 5 seconds.  
The current custom code will be displayed (initially set to A).
- Press **(TEMP)** (**↕**) to change the custom code between A↔B↔C↔D (A→b→c→d).  
\* Match the custom code on the display to the air conditioner custom code.
- Press **(MODE)** again.  
The custom code will be set.  
The display will return to the clock display.

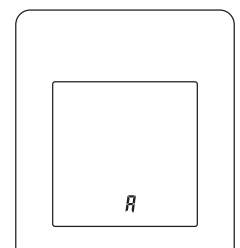

- To change the air conditioner custom code, contact an authorized service personnel (initially set to A).
- If you do not press any buttons for 30 seconds after the custom code is displayed, the display returns to the clock display. In this case, repeat the setting from step 2.
- Depending on the remote controller, the custom code may return to A when replacing the batteries. In this case, reset the custom code as necessary. If you do not know the air conditioner custom code, try each code until you find the code which operates the air conditioner.

## 10. CLEANING AND CARE

### CAUTION

- Before cleaning this product, be sure to turn it off and disconnect all the power supply.
  - Before starting operation, make sure that the intake grille has been shut completely. Incomplete closing of the intake grille might have an effect on the proper working or performance of the air conditioner.
  - If the filter cleaning involves high-place work, please consult the authorized service personnel.
- Do not touch the aluminum fins of heat exchanger built-in the indoor unit to avoid personal injury when you maintain the unit.
  - Do not expose the indoor unit to liquid insecticides or hair sprays.
  - Do not stand on slippery, uneven or unstable surfaces when you maintain the unit.

The frequency of the cleaning is as shown in the following table.

What to do	Frequency
Cleaning indoor unit body	When you notice
Cleaning air filter	Every 2 weeks
Cleaning Ion deodorization filter	Every 3 months
Replacing Apple-catechin filter (Model name: UTR-FA16)	
Replacing Ion deodorization filter (Model name: UTR-FA16-2)	Every 3 years

\* The air cleaning filters are sold separately. When you replace them, please contact the store of purchase.

### Cleaning indoor unit body

#### NOTES:

- Do not use water hotter than 40 °C.
  - Do not use scouring cleanser, volatile solvents such as benzene or thinner.
1. Wipe the indoor unit body gently with a soft cloth moisten with warm water.
  2. Wipe the indoor unit body gently with a dry and soft cloth.

### Cleaning air filter

1. Remove the Intake Grille.

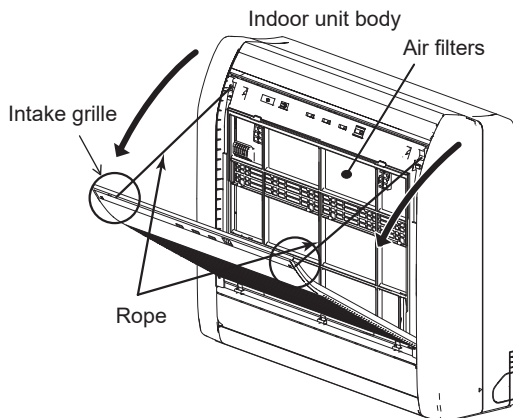

2. Remove the air filter.  
Lift up the air filter and pull out.

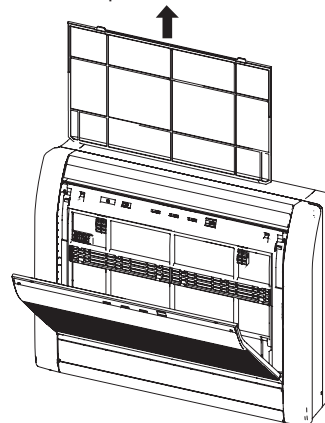

3. Remove the dust in either of the following ways.
  - Cleaning with vacuum cleaner.
  - Washing with mild detergent and warm water. After washing, dry the air filter thoroughly in shade.
4. Replace the Air Filter and close the Intake Grille.  
Align the sides of the air filter with the panel, and push in fully, making sure the 2 upper tabs are returned properly to their holes in the panel.

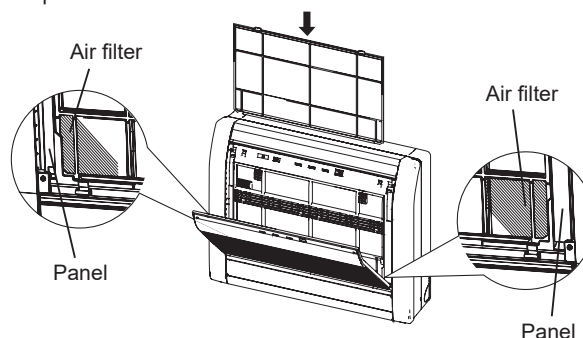

5. Close the intake grille.

**NOTES:** If dirt accumulates on the air filter, airflow will be reduced, operating efficiency will lower, and the noise will increase.

### Cleaning Ion deodorization filter and Replacing Apple-catechin filter

1. Remove the air filters. Refer to steps 1 ~ 2 of "Cleaning air filter".
2. Remove the air cleaning filters from the air cleaning filter holder.

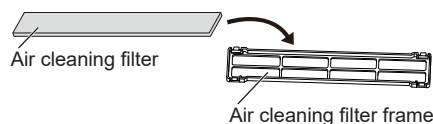

3. Flush the Ion deodorization filter (light blue) with high-pressure hot water until the surface of the filters are covered with water.
4. Wash the Ion deodorization filter with diluent neutral detergent.  
Do not ream or rub, otherwise the deodorizing effect may decrease.
5. Rinse the Ion deodorization filter with water flow.
6. Dry the Ion deodorization filter in shade.
7. Remove the Apple-catechin filter (light green) from the air cleaning filter holder.

- Set the new or washed air cleaning filters into the air cleaning filter frames.

**NOTES:** Use the Apple-catechin filter as soon as possible after opening the package. The air cleaning effect decreases when the filters are left in the opened package.

- Install the air cleaning filter holders to the air filters.  
Engage the 4 hooks at the rear of the air cleaning filter frame with the latch at both ends of the air filter.  
\* Take care that the air cleaning filter does not project beyond the frame.

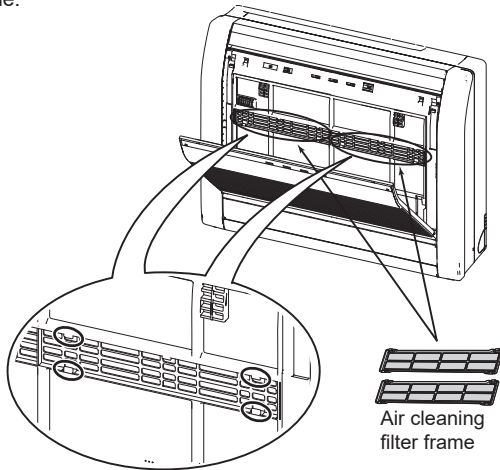

**NOTES:** Take care that the air cleaning filter does not project beyond the frame.

- Replace the air filter and close the intake grille. Refer to steps 4 ~ 5 of "Cleaning air filter".

### Replacing Ion deodorization filter

- Remove the air filters. Refer to steps 1 ~ 2 of "Cleaning air filter".
- Remove the Ion deodorization filter (light blue) from the air cleaning filter holder.
- Install the new Ion deodorizing filter.

### After extended non-use of the unit

If you have shut down the indoor unit for 1 month or more, perform the Fan mode operation for half a day to dry the internal parts thoroughly before the normal operation.

### Additional inspection

After long period of use, accumulated dust inside the indoor unit may reduce the performance even if you have maintained the unit properly. In such a case, a product inspection is recommended. For more information, consult authorized service personnel.

### Filter indicator reset (Special setting)

This function can be used if set correctly during installation. Please consult authorized service personnel in order to use this function.

☞ Clean the air filter when the indicator lamp show the following:

Indicator lamp	Blinking pattern
TIMER OPERATION ECONOMY ○ ○	Blinks 3 times, at intervals of 21 seconds

After cleaning, reset the filter indicator by pushing on the indoor unit for 2 seconds or less.

## 11. GENERAL INFORMATION

### ■ Heating performance

This air conditioner operates on the heat-pump principle, absorbing heat from air outdoors and transferring that heat to the indoor unit. As a result, the operating performance is reduced as outdoor air temperature drops.

If you feel that the heating performance is insufficient, we recommend you to use this air conditioner in conjunction with other kinds of heating appliance.

### ■ Automatic defrosting operation

When outdoor temperature is very low with high humidity, frost may form on the outdoor unit during the heating operation, and it could reduce the operating performance of the product.

For frost protection, a microcomputer-controlled automatic defrost function is equipped in this air conditioner.

If frost forms, the air conditioner will temporarily stop, and defrost circuit will operate briefly (maximum of 15 minutes.)

[ ] indicator on the indoor unit blinks during this operation.

If frost forms on the outdoor unit after the Heating operation, the outdoor unit will stop automatically after it operates for a few minutes. Then the Automatic defrosting operation starts.

### ■ Auto-restart function

In event of power interruption such as a blackout, the air conditioner stops once. But it restarts automatically and performs previous operation when the power supply is resumed.

If any power interruption occurs after the timer is set, counting down of the timer will be reset.

After the power supply is resumed, [ ] indicator on the indoor unit blinks to notify you that there has been a timer fault. In such a case, reset the clock and timer settings.

### ■ Malfunctions caused by other electrical devices

Use of other electrical appliances such as an electric shaver or nearby use of a wireless radio transmitter may cause the malfunction of the air conditioner.

If you encounter such a malfunction, turn off the circuit breaker once. Then turn it on again, and resume operation by using the remote controller.

### ■ Indoor unit temperature and humidity range

Permissible ranges of temperature and humidity are as follows:

Indoor temperature	Cooling/Dry	[°C]	18.0 to 30.0
	Heating	[°C]	16.0 to 30.0
Indoor humidity		[%]	80 or less *1)

\*1) If the air conditioner is used continuously for many hours, water may condense on the surface and drip.

- If the unit is operated under the conditions except the permissible temperature range, the air conditioner operation may stop because of the automatic protection circuit working.
- Depending on the operating conditions, the heat exchanger may freeze, causing water leakage or other malfunction (in the Cooling or Dry mode).

### ■ Other information

- Do not use the air conditioner for any purpose other than room cooling/dry, room heating or fan.
- For the permissible ranges of temperature and humidity for the outdoor unit, refer to the outdoor unit installation manual.



## 12. OPTIONAL PARTS

### 12.1. Wired remote controller

The optional wired remote controller can be used.

**You can use wired and wireless remote controller together.**

However, some functions of the wireless remote controller are restricted.

If you set the restricted functions, beeping sound will be heard, [    ] indicator on the indoor unit will blink.

<Restricted functions for wireless remote controller>

When using together with wired remote controller (2-wired type)

- Weekly timer operation
- Powerful operation
- Outdoor Unit Low Noise operation
- 10 °C Heat operation

You can use wired remote controller and wireless LAN control (optional).

However, some operations from the mobile app are restricted.

**Multiple remote controller**

You can connect two wired remote controllers to one air conditioner.

Either remote controller can control the air conditioner.

However, the timer functions cannot be used by the secondary unit.

### 12.2. Multi-split type air conditioner

This indoor unit can be connected to a multi-split type outdoor unit. The multi-split type air conditioner allows multiple indoor units to be operated in multiple locations. The indoor units may be operated simultaneously, in accordance with their respective output.

#### Simultaneous Use of Multiple Units

- When using a multi-split type air conditioner, the multiple indoor units can be operated simultaneously, but when 2 or more indoor units of the same group are operated simultaneously, the heating and cooling efficiency will be less than when a single indoor unit is used alone. Accordingly, when you wish to use more than 1 indoor unit for cooling at the same time, the use should be concentrated at night and other times when less output is required. In the same way, when multiple units are used simultaneously for heating, it is recommended that they be used in conjunction with other auxiliary space heaters, as required.
- Seasonal and outdoor temperature conditions, the structure of the rooms and the number of persons present may also result in differences of operating efficiency. We recommend that you try various operating patterns in order to confirm the level of heating and cooling output provided by your units, and use the units in the way that best matches your family's lifestyle.
- If you discover that 1 or more units delivers a low level of cooling or heating during simultaneous operation, we recommend that you stop simultaneous operation of the multiple units.
- Operation cannot be done in the following different operating modes. If the indoor unit is instructed to do an operating mode that it cannot perform, [  ] indicator on the indoor unit will flash (1 second on, 1 second off) and the unit will go into the standby mode.
  - Heating mode and Cooling mode (or Dry mode)
  - Heating mode and Fan mode
- Operation can be done in the following different operating modes.
  - Cooling mode and Dry mode
  - Cooling mode and Fan mode
  - Dry mode and Fan mode

- The operating mode (Heating mode or Cooling (Dry) mode) of the outdoor unit will be determined by the operating mode of the indoor unit that was operated first. If the indoor unit was started in the Fan mode, the operating mode of the outdoor unit will not be determined.

For example, if indoor unit (A) was started in the Fan mode and then indoor unit (B) was then operated in the Heating mode, indoor unit (A) would temporarily start operation in the Fan mode but when indoor unit (B) started operating in the Heating mode, [  ] indicator for indoor unit (A) would begin to flash (1 second on, 1 second off) and it would go into standby mode. Indoor unit (B) would continue to operate in Heating mode.

## 13. TROUBLESHOOTING

### WARNING

 In the following events, immediately stop operation of the air conditioner, and disconnect all the power supply by turning off the electrical breaker or disconnecting the power plug. Then consult your dealer or authorized service personnel.

As long as the unit is connected to the power supply, it is not insulated from the power supply even if the unit is turned off.

- Unit smells of something burning or emits smoke
- Water leaks from the unit

#### Does not operate at all.

- Has there been a power outage?  
In this case, the unit restarts automatically after the power supply is resumed. (Refer to **page 10**.)
- Has the circuit breaker been turned off?  
⇒ Turn on the circuit breaker.
- Has a fuse blown out or the circuit breaker been tripped?  
⇒ Replace the fuse or reset the circuit breaker.
- Is the timer operating?  
⇒ To check or deactivate the timer setting, refer to **page 5**.

#### Poor cooling or heating performance.

- Is the unit operating under the conditions except the permissible temperature range?  
In this case, the air conditioner may stop because of the automatic protection circuit working.
- Is the air filter dirty?  
⇒ Clean the air filter. (Refer to **page 9**.)
- Is the intake grille or outlet port of indoor unit blocked?  
⇒ Remove the obstructions.
- Is the room temperature adjusted appropriately?  
⇒ To change the temperature setting, refer to **page 5**.
- Is a window or door left opened?  
⇒ Close the window or the door.
- Is the fan speed set to Quiet?  
⇒ To change the fan speed, refer to **page 5**.
- Has the Outdoor Unit Low Noise operation been set?  
⇒ To stop the Outdoor Unit Low Noise operation, refer to **page 8**.
- <In the Cooling mode> Is direct or strong sunlight shining into the room?  
⇒ Close the curtains.
- <In the Cooling mode> Are there other heating apparatus or computers operating, or too many people in the room?  
⇒ Turn the heating apparatus or computers off, or set the temperature lower. (Refer to **page 5**.)

#### Airflow is weak or stops.

- Is the fan speed set to Quiet?  
⇒ To change the fan speed, refer to **page 5**.
- Has the Fan Control for Energy Saving set? In this case, the indoor unit fan may stop temporarily while the Cooling operation.  
⇒ To cancel the Fan control for energy saving, refer to **page 8**.

- <In the Heating mode> Have you just started the operation?  
In this case, the fan rotates at very low speed temporarily to warm up the internal parts of the unit.
- <In the Heating mode> Is the room temperature higher than the set temperature?  
In this case, the outdoor unit stops and the indoor unit fan rotates at very low speed.
- <In the Heating mode> Is [  ] indicator on the indoor unit blinking?  
In this case, the Automatic defrosting operation is working. The indoor unit stops for maximum of 15 minutes. (Refer to **page 10.**)
- <In the Dry mode> The indoor unit operates at low fan speed to adjust the room humidity, and may stop from time to time.
- <In the Auto mode> While the monitoring operation, the fan rotates at very low speed.

#### Noise is heard.

- Is the unit operating, or immediate after stopping operation?  
In this case, refrigerant flowing sound may be heard. It may be particularly noticeable for 2-3 minutes after starting operation.
- Do you hear a slight squeaking sound during the operation?  
This sound is produced by the minute expansion and contraction of the front panel caused by temperature change.
- <In the Heating mode> Do you hear a sizzling sound?  
This sound is produced by the Automatic defrosting operation. (Refer to **page 10.**)

#### Smell coming from the unit.

- The air conditioner may absorb various smells generated from interior textile, furniture, or cigarette smoke. These smells may be emitted during the operation.

#### Mist or steam is emitted from the unit.

- <In the Cooling or Dry mode> A thin mist may be generated by condensation formed with sudden cooling process.
- <In the Heating mode> Is [  ] indicator on the indoor unit blinking?  
In this case, steam may rise from the outdoor unit because of the Automatic defrosting operation. (Refer to **page 10.**)

#### Outdoor unit emits water.

- <In the Heating mode> The outdoor unit may emit water generated by the Automatic defrosting operation. (Refer to **page 10.**)

#### The unit operates differently from the remote controller setting.

- Are the batteries in the remote controller exhausted?  
⇒ Replace the batteries.

#### Operation is delayed after restart.

- Has the power supply turned from Off to On suddenly?  
In this case, the compressor will not operate for about 3 minutes to prevent a blowout of the fuse.

#### Does not operate at all.

- Is the [  ] indicator on the indoor unit blinking? (Refer to **page 12.**)  
Refrigerant leakage sensor error and harness disconnection/connection failure may have occurred.  
Contact an authorized service personnel.



#### The unit operates differently from the remote controller setting.

- Is the [  ] indicator on the indoor unit blinking? (Refer to **page 12.**)  
Refrigerant may have been leaked. Blowing operation is performed to prevent the refrigerant from accumulating.  
Open the windows to ventilate the room and contact an authorized service personnel.

#### The product starts to run on its own



























- Is the [  ] indicator on the indoor unit blinking? (Refer to **State of indicator lamps.**)  
Refrigerant may have been leaked. Blowing operation is performed to prevent the refrigerant from accumulating.  
Open the windows to ventilate the room and contact an authorized service personnel.

Immediately stop operation and turn off the electrical breaker in following cases. Then consult authorized service personnel.

- The problem persists even if you perform these checks or diagnostics.
- On the indoor unit, [  ] and [  ] blink while [  ] is blinking fast.

## State of indicator lamps

Lighting pattern:  Blinking,  Any state

State	Causes and solutions	See page
TIMER OPERATION ECONOMY   	Automatic defrosting operation ⇒ Please wait until finishing the defrosting (maximum of 15 minutes).	10
TIMER OPERATION ECONOMY    (3 times)	Filter indicator ⇒ Clean the air filter and reset the filter sign.	10
TIMER OPERATION ECONOMY    (Fast)	Error code display ⇒ Consult authorized service personnel.	-
TIMER OPERATION ECONOMY   	Timer setting error because of Auto restart ⇒ Reset the clock and timer settings.	10
TIMER OPERATION ECONOMY   	Test run operation (for authorized personnel only) ⇒ Press  to quit the test run.	3
TIMER OPERATION ECONOMY    (8 times) (Fast)	Refrigerant leakage suspicion ⇒ Blowing operation is performed to prevent the refrigerant from accumulating. Open the windows to ventilate the room and contact an authorized service personnel. * Press the  button to stop the buzzer sound.	-
TIMER OPERATION ECONOMY    (4 times) (Fast)	Refrigerant leakage sensor error ⇒ Sensor may have occurred. Contact an authorized service personnel. * Operation may be performed, however, contact an authorized service personnel	-
TIMER OPERATION ECONOMY   	Restricted function	11

## Manual Auto operation and Filter indicator -

You can operate the air conditioner with  on the indoor unit.

Status	Time to keep pressing	Mode or operation
In operation	More than 3 seconds	Stop
Stopping	2 seconds or less	Filter indicator reset
	More than 3 seconds and less than 10 seconds	Auto *1)
	More than 10 seconds (Only for servicing.*2)	Forced cooling

\*1) In multi connection, the operation mode follows the other indoor units.

\*2) To stop the forced cooling, press this button or  on the remote controller.