

# daitso

REFRIGERANT  
**R32**

**USER MANUAL**



## **AIWD URBAN II**

Serie

**AIWD URBAN II**

Edition

**06/22**

Models

**AIWD URBAN II 100-190L**

**AIWD URBAN II 100-240L**

**AIWD URBAN II 160-240L**

- This manual gives detailed description of the precautions that should be brought to your attention during operation.
- In order to ensure correct service of the wired controller, please read this manual carefully before using the unit.
- For convenience of future reference, keep this manual after reading it.

# CONTENTS

---

## 1 GENERAL SAFETY PRECAUTIONS

- 1.1 About the documentation ..... 01
- 1.2 For the user ..... 02

## 2 A GLANCE OF THE USER INTERFACE

- 2.1 The appearance of the wired controller ..... 05
- 2.2 Status icons ..... 06

## 3 USING HOME PAGES

- 3.1 About home pages ..... 07

## **4 MENU STRUCTURE**

- 4.1 About the menu structure ..... 11
- 4.2 To go to the menu structure ..... 11
- 4.3 To navigate in the menu structure ..... 11

## **5 BASIC USAGE**

- 5.1 Screen unlock ..... 12
- 5.2 Turning ON/OFF controls ..... 14
- 5.3 Adjusting the temperature ..... 19
- 5.4 Adjusting space operation mode ..... 22

## **6 NETWORK CONFIGURATION GUIDELINES**

- 6.1 Wired controller setting ..... 25
- 6.2 Mobile device setting ..... 28

## **7 INSTALLATION MANUAL**

- 7.1 Safety precaution ..... 35
- 7.2 Other precautions ..... 38
- 7.3 Installation procedure and matching setting of  
wired controller ..... 39
- 7.4 Front cover installation ..... 46

## **8 MODBUS MAPPING TABLE**

- 8.1 Modbus port communication specification ..... 48

# 1 GENERAL SAFETY PRECAUTIONS

## 1.1 About the documentation

- The original documentation is written in English. All other languages are translations.
- The precautions described in this document cover very important topics, follow them carefully.
- All activities described in the installation manual must be performed by an authorized installer.

### 1.1.1 Meaning of warnings and symbols

#### **DANGER**

Indicates a situation that results in death or serious injury.

---

#### **DANGER: RISK OF ELECTROCUTION**

Indicates a situation that could result in electrocution.

---

#### **DANGER: RISK OF BURNING**

Indicates a situation that could result in burning because of extreme hot or cold temperatures.

## **WARNING**

Indicates a situation that could result in death or serious injury.

---

## **CAUTION**

Indicates a situation that could result in minor or moderate injury.

---

## **NOTE**

Indicates a situation that could result in equipment or property damage.

---

## **INFORMATION**

Indicates useful tips or additional information.

### **1.2 For the user**

- If you are not sure how to operate the unit, contact your installer.

- The appliance is not intended for use by persons, including children, with reduced physical, sensory or mental capabilities, or lack of experience and knowledge, unless they have been given supervision or instruction concerning use of the appliance by a person responsible for their safety. Children must be supervised to ensure that they do not play with the product.



## CAUTION

Do NOT rinse the unit. This may cause electric shocks or fire.

---



## NOTE

- Do NOT place any objects or equipment on top of the unit.
- Do NOT sit, climb or stand on the unit.

- Units are marked with the following symbol:



This means that electrical and electronic products may not be mixed with unsorted household waste. Do not try to dismantle the system yourself: the dismantling of the system, treatment of the refrigerant, of oil and of other parts must be done by an authorized installer and must comply with applicable legislation. Units must be treated at a specialized treatment facility for reuse, recycling and recovery. By ensuring this product is disposed of correctly, you will help to prevent potential negative consequences for the environment and human health. For more information, contact your installer or local authority.

## 2 A GLANCE OF THE USER INTERFACE

### 2.1 The appearance of the wired controller

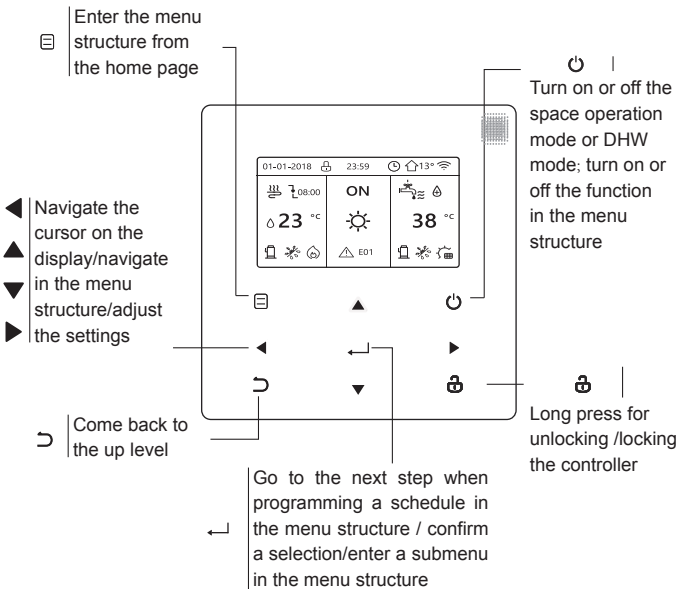



## 2.2 Status icons

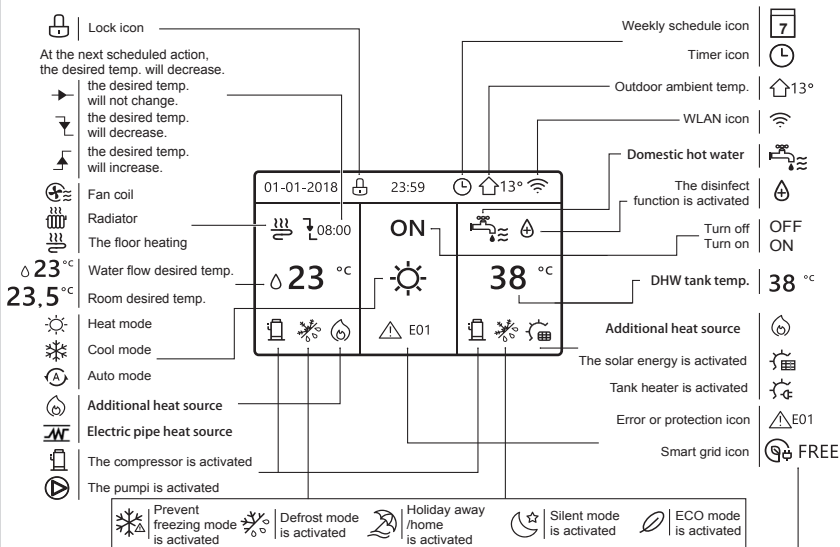

	Fan coil	Radiator	The floor heating	Domestic hot water
ON				
OFF				

	Free electricity	Valley electricity	Peak electricity
Smart grid	FREE	VALLEY	PEAK

## 3 USING HOME PAGES

### 3.1 About home pages

You can use the home pages to read out and change settings that are meant for daily usage. What you can see and do on the home pages is described where applicable. Depending on the system layout, the following home pages may be possible:

- Room desired temperature (ROOM )
- Water flow desired temperature (MAIN)
- DHW tank actual temperature (TANK)

DHW=domestic hot water

home page1 :

If you have set the WATER FLOW TEMP. as YES and ROOM TEMP. as NON, the system has the function including floor heating and making hot water. The following page will appear:

NOTE

All the pictures in the manual are used to explain, the actual pages in the screen may have some difference.

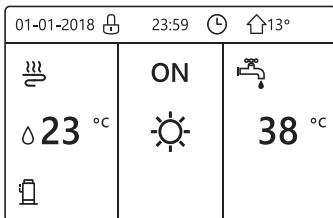







home page2 :

If you have set the WATER FLOW TEMP. as NON and ROOM TEMP. as YES, the system has the function including floor heating and making hot water. The following page will appear:

#### NOTE

The interface should be installed in the floor heating room to check the room temperature.

01-01-2018 	23:59 	 13°
 <b>23.5 °C</b> 	<b>ON</b> 	 <b>38 °C</b>

### home page3 :

If the DHW MODE is set NON , and if "WATER FLOW TEMP." is set YES, "ROOM TEMP." is set YES, There will be main page and additional page. The system has the function including floor heating and space cooling for fan coil, home page 3 will appear:

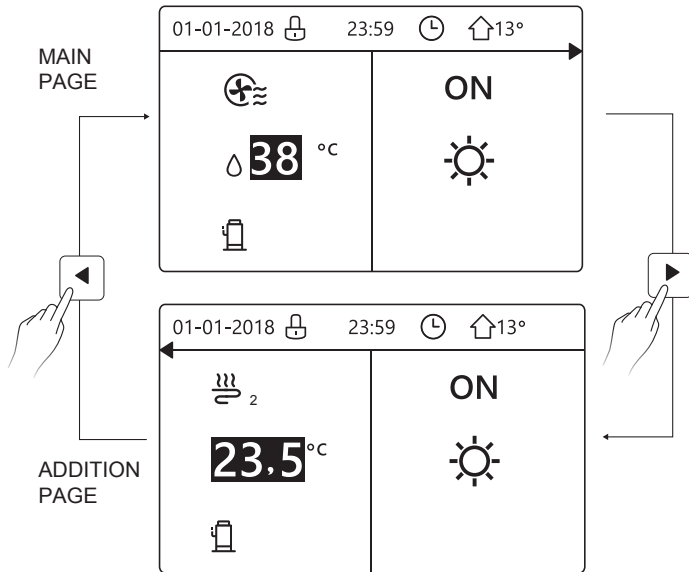

## home page4 :

If the DHW MODE is set YES. There will be main page and addition page. The system has the function including floor heating, space cooling for fan coil and domestic hot water, home page 4 will appear:

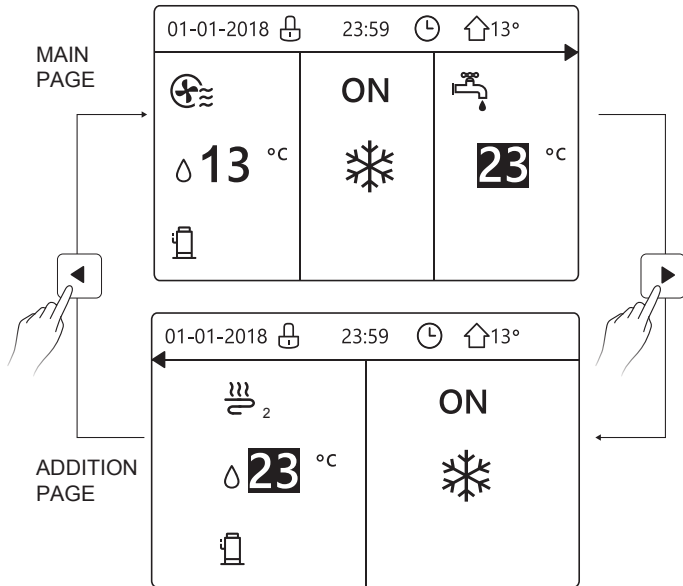



## 4 MENU STRUCTURE



### 4.1 About the menu structure

You can use the menu structure to read out and configure settings that are NOT meant for daily usage. What you can see and do in the menu structure is described where applicable.

### 4.2 To go to the menu structure

From a home page, press "  ". Result: The menu structure appear:

MENU	1/2
<b>OPERATION MODE</b>	
PRESET TEMPERATURE	
DOMESTIC HOT WATER(DHW)	
SCHEDULE	
OPTIONS	
CHILD LOCK	
 ENTER	

MENU	2/2
<b>SERVICE INFORMATION</b>	
OPERATION PARAMETER FOR SERVICEMAN	
WLAN SETTING	
SN VIEW	
 ENTER	

### 4.3 To navigate in the menu structure



Use"▼", "▲" to scroll.

## 5 BASIC USAGE

### 5.1 Screen Unlock

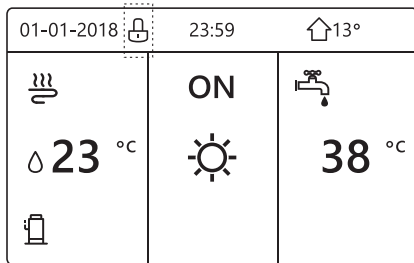
If the icon  is on the screen, the controller is locked. The following page is displayed:



Press any key, the icon  will flash. Long press the "  " key. The icon  will disappear, the interface can be controlled.

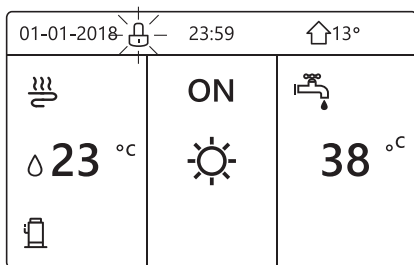

The interface will be locked if there is no handling for a long time (about 120 seconds). If the interface is unlocked, long press "🔒", the interface will be locked.

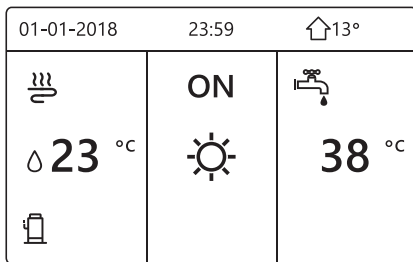

Long press



Long press

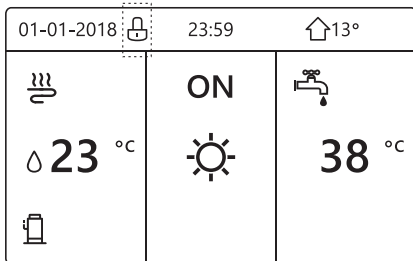





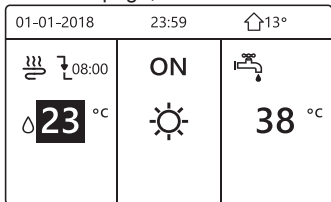

## 5.2 Turning ON/OFF controls

Use the interface to turn on or off the unit for space heating or cooling.

- The ON/OFF of the unit can be controlled by the interface if the ROOM THERMOSTAT is NON. (See "ROOM THERMOSTAT SETTING" in "Installation and owner's manual (M-thermal split indoor unit)")
- Press "◀", "▲" on home page, the black cursor will appear:



1 ) When the cursor is on the temperature of space operation mode side (Including heat mode , cool mode  and auto mode  ), press "⏻" key to turn on/off space heating or cooling.

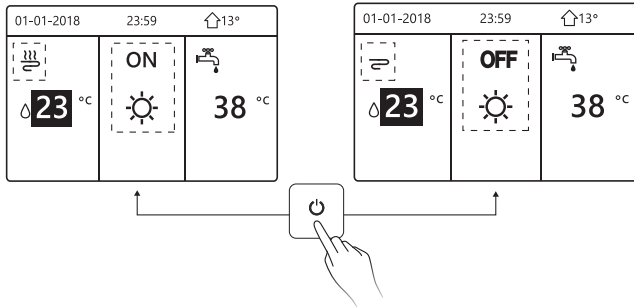

If the DHW TYPE is set NON, then following pages will display:

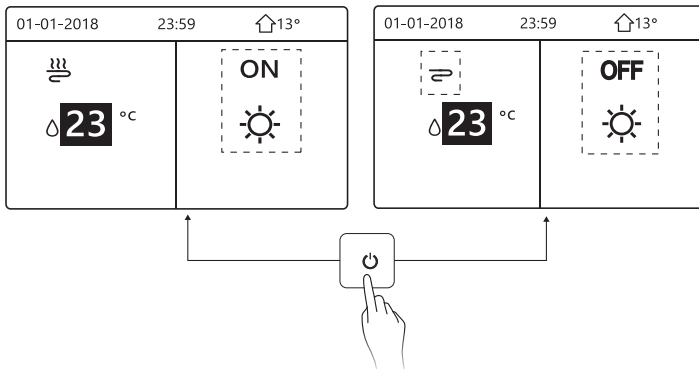

If the TEMP. TYPE is set ROOM TEMP., then following pages will display:

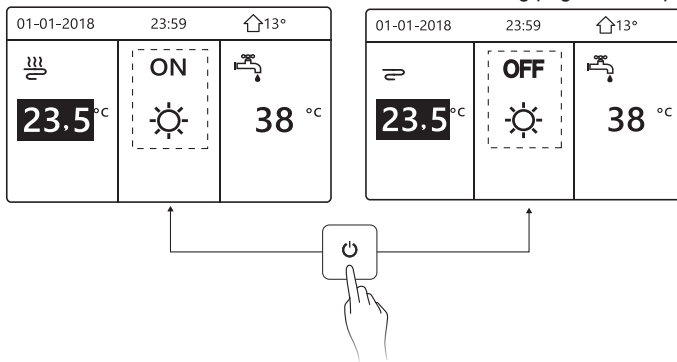

Use the room thermostat to turn on or off the unit for space heating or cooling.

① The room thermostat is SET YES(see "ROOM THERMOSTAT SETTING" on "Installation and owner's manual (M-thermal split indoor unit)") the unit is turned on or off by the room thermostat, press  on the interface, the following page will display:

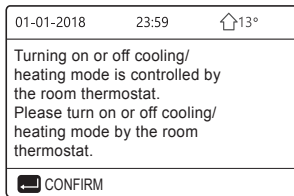

② DUAL ROOM THERMOSTAT is set YES(see "ROOM THERMOSTAT SETTING" in "Installation and owner's manual (M-thermal split indoor unit)"). The room thermostat for fan coil is turned off ,the room thermostat for the floor heating is turned on,and the unit is running, but the display is OFF. The following page is displayed:

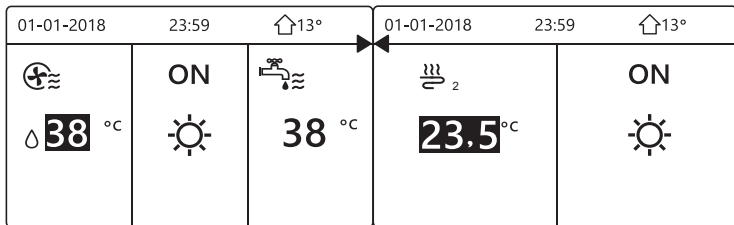

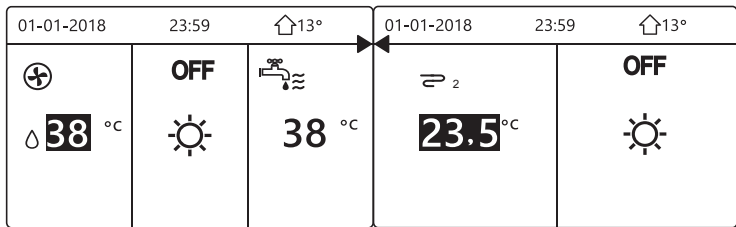

Use the interface to turn on or off the unit for DHW. Press "►", "▼" on home page, the black cursor will appear:

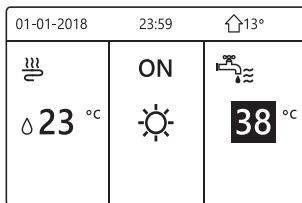

2) When the cursor is on DHW operation mode. Press " ⏻ " key to turn on/off the DHW mode.

If the space operation is ON, then following pages will display:

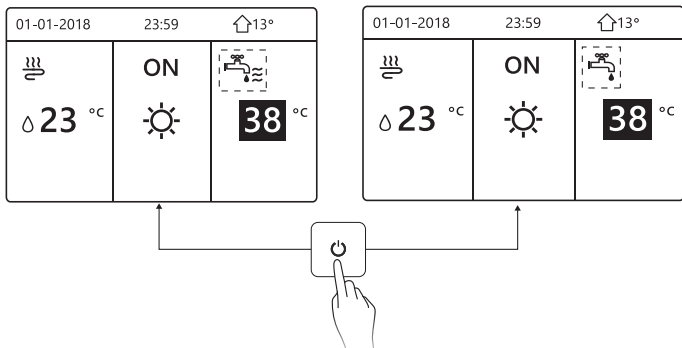

If the space operation mode is OFF, then following pages will display:

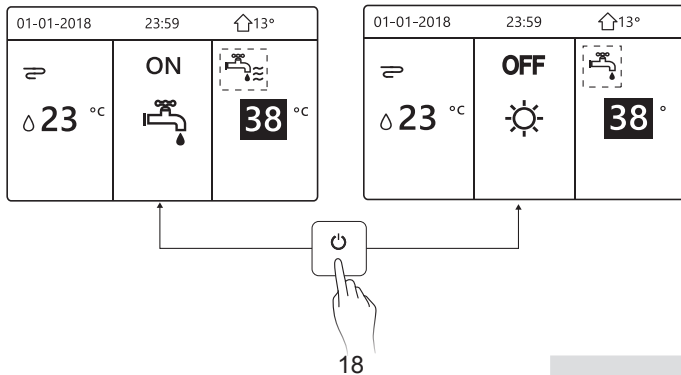

### 5.3 Adjusting the temperature

Press "◀", "▲" on home page, the black cursor will appear:

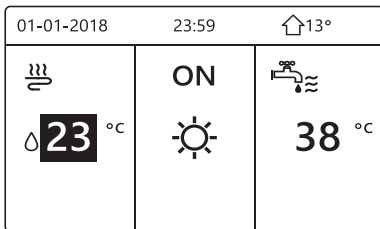

- If the cursor is on the temperature, use the "◀", "▶" to select and use "▼", "▲" to adjust the temperature.

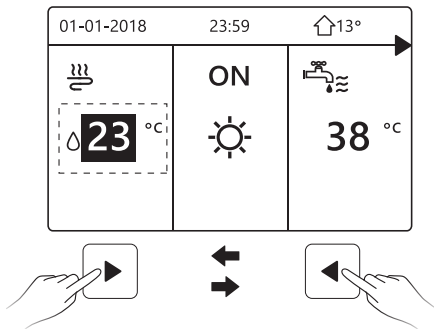

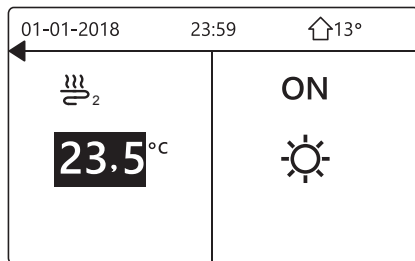
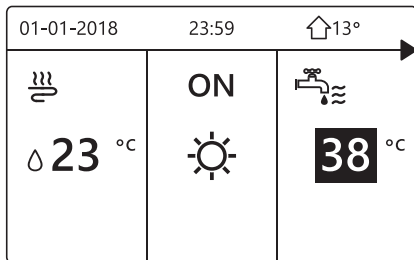

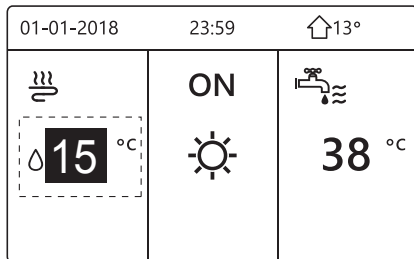
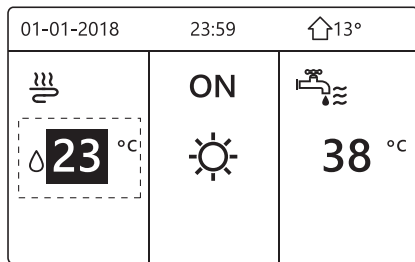



## 5.4 Adjusting space operation mode

- Adjusting space operation mode by interface. Go to "☰" > "OPERATION MODE". Press "↵", the following page will appear:

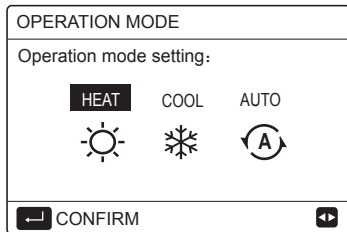

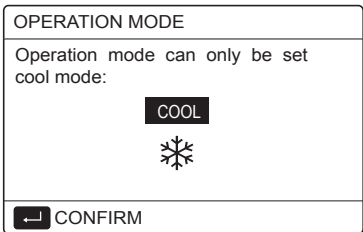
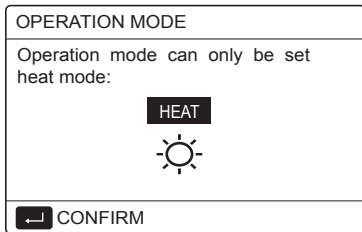

- There are three modes to be selected including HEAT, COOL and AUTO mode. Use the "◀", "▶" to scroll, press "↵" to select. Even if you don't press OK button and exit the page by pressing "⏪" button, the mode would still effective if the cursor have be moved to the operation mode.

If there is only HEAT(COOL) mode, the following page will appear:





- The operation mode can not be changed see cool MODE SETTING on installation and owner's manual.



If you select...	Then the space operation mode is...
 heat	Always heating mode
 cool	Always cooling mode
 auto	<p>Automatically changed by the software based on the outdoor temperature (and depending on installer settings of the indoor temperature), and takes monthly restrictions into account.</p> <p>Note: Automatic changeover is only possible under certain conditions.</p> <p>See the FOR SERVICEMAN&gt; AUTO MODE SETTING in "Installation and owner's manual (M-thermal split indoor unit)".</p>

- Adjust space operation mode by the room thermostat, see "ROOM THERMOSTAT" on "Installation and owner's manual (M-thermal split indoor unit)".

Go to  >OPERATION MODE, if you press any key to select or adjust, the follpage will appear:



01-01-2018	23:59	 13°
Cool/heat mode is controlled by the room thermostat.		
Please adjust the operation mode by the room thermostat.		
 CONFIRM		

## 6 Network Configuration Guidelines

- The wired controller realizes intelligent control with a built-in module, which receives control signal from the APP.
- Before connecting the WLAN, please check for it if the router in your environment is active and make sure that the wired controller is well-connected to the wireless signal.
- During the Wireless distribution process, the LCD icon “” flashes to indicate that the network is being deployed. After the process is completed, the icon “” will be constantly on.

### 6.1 Wired Controller Setting

The wired controller settings include AP MODE and RESTORE WLAN SETTING.

WLAN SETTING
<b>AP MODE</b>
RESTORE WLAN SETTING
 ENTER 

- Activate the WLAN by interface. Go to "☰"> "WLAN SETTING"> "AP MODE".

Press "↵", the following page will appear:

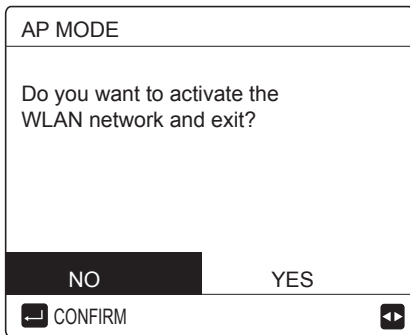



Use "◀", "▶" to move to "YES", press "↵" to select AP mode. Select AP Mode correspondingly on the mobile device and continue the follow-up settings according to the APP prompts.



### CAUTION

After enter Ap mode, if it's not connected with mobile phone, the LCD icon "📶" will flash 10 minutes then disappear.

If it's connected with the mobile phone, the icon "📶" will be constantly display.

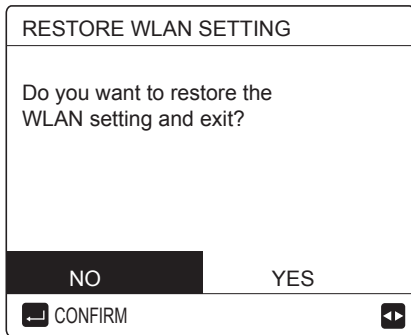
- Restore WLAN setting by interface. Go to “”> “WLAN SETTING” > “RESTORE WLAN SETTING”. Press “”, the following page will appear:



Use “”, “” to move to “YES”, press “” to restore WLAN setting. Complete the above operation and wireless configuration is reset.

## 6.2 Mobile Device Setting

AP Mode is available for wireless distribution on mobile device side.

- AP Mode connecting WLAN:

### 6.2.1 Install APP

- ① Scan the following QR code to install the Smart Home APP.



- ② When it is installed for the first time you have to put an access code, or scan a QR code. This code is the word "EUROFRED"  
This app is only applicable to Android 7.0 and IOS7, or up-to-date version operating systems.



EUROFRED

## 6.2.2 Sign in/Sign up

Please input your registration code.

Or scan the QR code on the controller packaging box if existed.

And register your account according to the guidance.

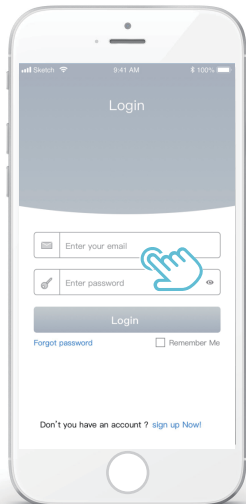
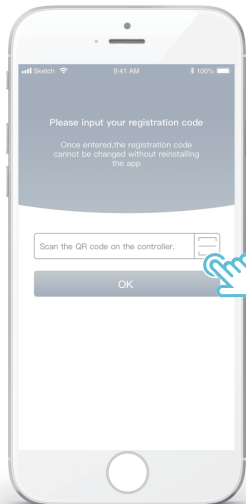



## 6.2.3 Add Home Appliances:

- 1) Add your device following the guidance.

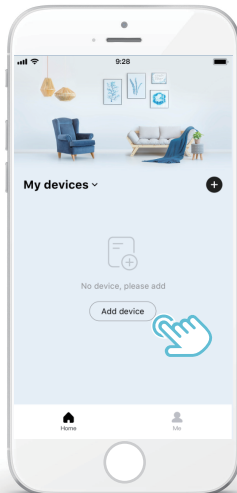

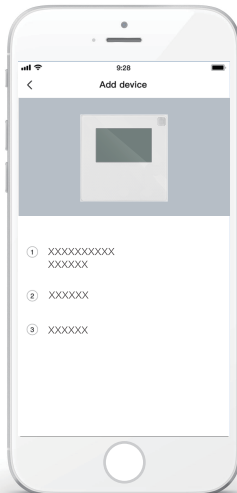

2) Operate the wired controller according to APP prompts.

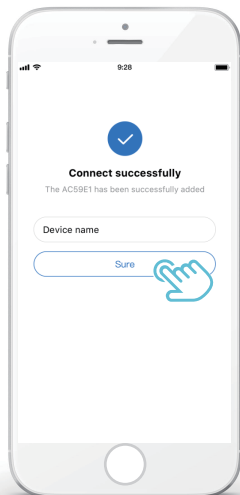

3) Wait for the home appliance to connect, and click “Sure”.

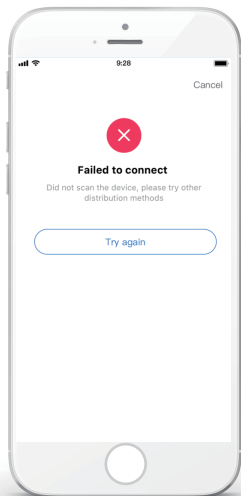

- 4) After the appliance is successfully connected, the LCD icon“



## Warning and troubleshooting for networking failures

When the product is connected to the network, please make sure that the phone is as close as possible to the product.

---

We only support 2.4GHz band routers at present.

---

Special characters (punctuation, spaces, etc.) are not recommended as part of the WLAN name.

---

It is recommended that you connect no more than 10 devices to a single router lest home appliances are affected by weak or unstable network signal.

---

If the password of the router or WLAN is changed, clear all settings and reset the appliance.

---

The contents of APP might change in version updates and actual operation shall prevail.

### WIFI information

WIFI transmit frequency range:2.400~2.4835 GHz  
EIRP not more than 20dbm

## 7 INSTALLATION MANUAL

### 7.1 Safety precaution

- Read the safety precautions carefully before installing the unit.
- Stated below are important safety issues that must be obeyed.
- Conform there is no abnormal phenomena during test operation after complete, then hand the manual to the user.
- Meaning of marks:



#### **WARNING**

Means improper handling may lead to personal death or severe injury.

---



#### **CAUTION**

Means improper handling may lead to personal injury or property loss.



## WARNING

Please entrust the distributor or professionals to install the unit. Installation by other persons may lead to imperfect installation, electric shock or fire.

---

Strictly follow this manual.  
Improper installation may lead to electric shock or fire.

---

Reinstallation must be performed by professionals.  
Improper installation may lead to electric shock or fire.

---

Do not disassemble your heat pump at will.  
A random disassembly may cause abnormal operation or heating, which may result in fire.

## CAUTION

Do not install the unit in a place vulnerable to leakage of flammable gases.

Once flammable gases are leaked and left around the wired controller, fire may occur.

---

The wiring should adapt to the wired controller current.

Otherwise, electric leakage or heating may occur and result in fire.

---

The specified cables shall be applied in the wiring. No external force may be applied to the terminal.

Otherwise, wire cut and heating may occur and result in fire.

---

Do not place the wired remote controller near the lamps, to avoid the remote signal of the controller to be disturbed. (refer to the right figure)





## 7.2 Other Precautions

### 7.2.1. Installation location

Do not install the unit in a place with much oil, steam, sulfide gas. Otherwise, the product may deform and fail.

### 7.2.2 Preparation before installation

1) Check whether the following assemblies are complete.

No.	Name	Qty.	Remarks
1	Wired Controller	1	_____
2	Cross round head wood mounting screw	3	For Mounting on the Wall
3	Cross round head mounting screw	2	For Mounting on the Electrical Switch Box
4	Installation and Owner's Manual	1	_____
5	Plastic bolt	2	This accessory is used when install the centralized control inside the electric cabinet
6	Plastic expansion pipe	3	For mounting on the Wall

### 7.2.3 Note for installation of wired controller:

- 1) This installation manual contains information about the procedure of installing Wired Remote Controller. Please refer to Indoor Unit Installation Manual for connection between Wired Remote Controller and Indoor Unit.
- 2) Circuit of Wired Remote Controller is low voltage circuit. Never connect it with a standard 220V/380V circuit or put it into a same Wiring Tube with the circuit.
- 3) The shielded cable must be connected stable to the ground, or transmission may fail.
- 4) Do not attempt to extend the shielded cable by cutting, if it is necessary, use Terminal Connection Block to connect.
- 5) After finishing connection, do not use Megger to have the insulation check for the signal wire.

### **7.3 Installation procedure and matching setting of wired controller**

### 7.3.1 Structure size figure

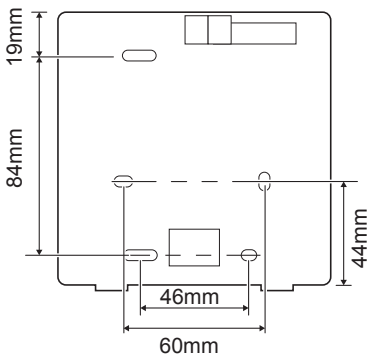
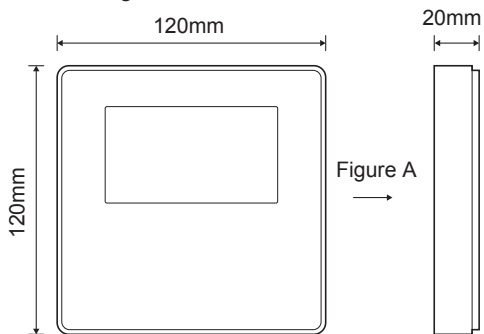

## 7.3.2 Wiring

Input Voltage(A/B)	13.5VAC
Wiring size	0.75mm <sup>2</sup>

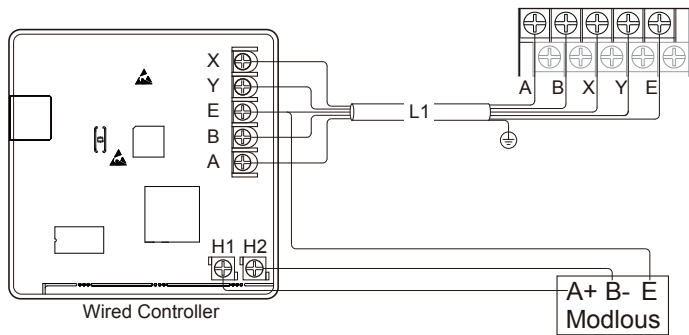

### 7.3.3 Back cover installation

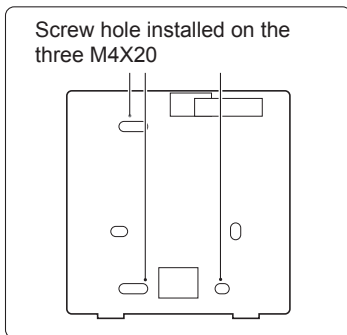
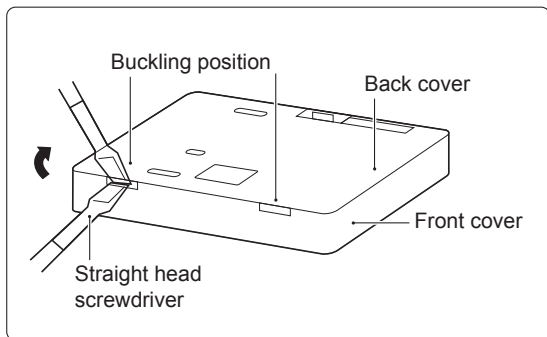

Screw hole installed on the  
three M4X20

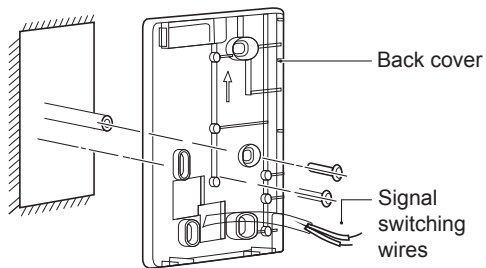
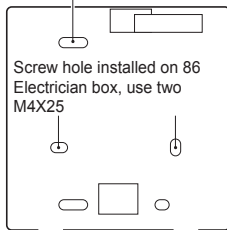

- 1) Use straight head screwdriver to insert in the buckling position in the bottom of wired controller, and spin the screwdriver to take down the back cover. (Pay attention to spinning direction, otherwise will damage the back cover!)
- 2) Use three M4X20 screws to directly install the back cover on the wall.
- 3) Use two M4X25 screws to install the back cover on the 86 electrician box, and use one M4X20 screws for fixing on the wall.
- 4) Adjust the length of two plastic screw bars in the accessory to be standard length from the electrical box screw bar to the wall. Make sure while installing the screw bar to the wall, making it as flat as the wall.
- 5) Use cross head screws to fix the wired controller bottom cover in the wall through the screw bar. Make sure the wired controller bottom cover is on the same level after installation, and then install the wired controller back to the bottom cover.
- 6) Over fastening the screw will lead to deformation of back cover.

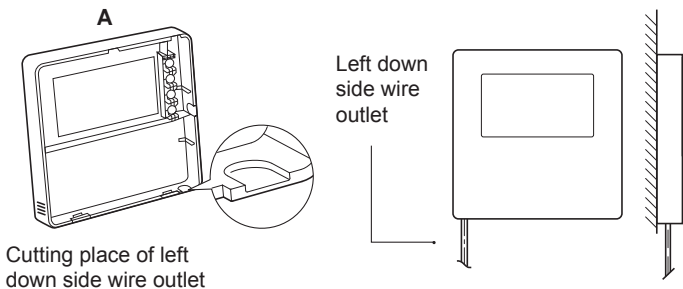

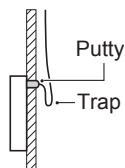
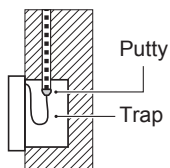
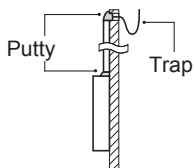
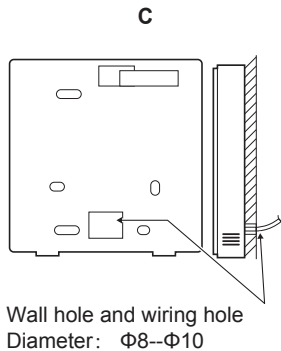
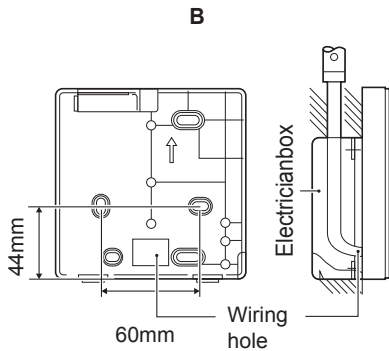

Avoid the water enter into the wired remote controller, use trap and putty to seal the connectors of wires during wiring installation.



## 7.4 Front cover installation

After adjusting the front cover and then buckle the front cover; avoid clamping the communication switching wire during installation.

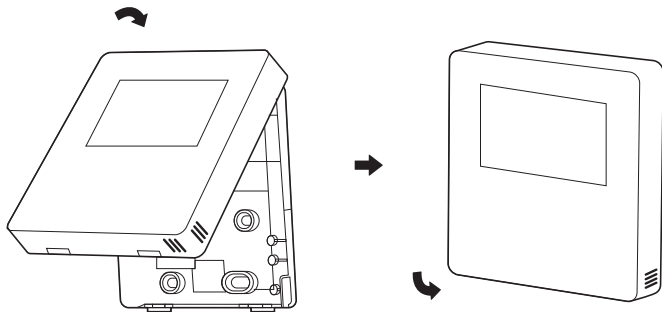

Sensor can not be affected with damp.

Correct install the back cover and firmly buckle the front cover and back cover, otherwise will make the front cover drop off.



## **8 MODBUS MAPPING TABLE**

### **8.1 Modbus Port Communication Specification**

Port: RS-485; the wired controller XYE is the communication port for connecting with the hydraulic module. H1 and H2 are the Modbus communication ports.

Communication address: It is consistent with the DIP switch address of the hydraulic module.

Baud rate: 9600.

Number of digits: Eight

Verification: none

Stop Bit: 1 bit

Communication protocol: Modbus RTU (Modbus ASCII is not supported)

### 8.1.1 Mapping of registers in the wired controller

The following addresses can use 03H, 06H (write single register), 10H (write multiple register)

Register address	Description	Remarks	
0 (PLC:40001)	Power on or off.	BIT15	Reserved
		BIT14	Reserved
		BIT13	Reserved
		BIT12	Reserved
		BIT11	Reserved
		BIT10	Reserved
		BIT9	Reserved
		BIT8	Reserved
		BIT7	Reserved
		BIT6	Reserved
		BIT5	Reserved
		BIT4	Reserved
		BIT3	0: power off floor heating; 1: power on floor heating;(zone 2) (water flow temperature control)
		BIT2	0: DHW(T5S) power off; 1: DHW(T5S) power on
		BIT1	0: power off floor heating; 1: power on floor heating;(zone 1) (water flow temperature control)
BIT0	0: power off air conditioner; 1: power on air conditioner; (zone 1) (room temperature control)		

1(PLC: 40002)	Setting the mode	1: Auto; 2: Cool; 3: Heat; Others: Invald	
2(PLC: 40003)	Setting water water temperature T1S	Bit8-Bit15	Water temperature T1s is corresponding to the floor heating.(zone 2)
		Bit0-Bit7	Water temperature T1s is corresponding to the floor heating.(zone 1)
3(PLC: 40004)	Setting air temperature Ts	The room temperature range is between 17°C and 30°C, and is valid when there is Ta. Portocol value=actual value*2	
4(PLC: 40005)	T5s	The water tank temperature range is between 20°C and 60°C.	
5(PLC: 40006)	Function Setting	BIT15	Reserved
		BIT14	Reserved
		BIT13	1: climate curve setting is valid; 0: climate curve setting is invalid. (zone2)
		BIT12	1: climate curve setting is valid; 0: climate curve setting is invalid. (zone1)
		BIT11	DHW pump's running constant-temperature water recycling
		BIT10	ECO mode
		BIT9	Reserved
		BIT8	Holiday home (the status can only be read, not changed)
		BIT7	0: Silent mode level1; 1: Silent mode level2
		BIT6	Silent mode
		BIT5	Holiday away (the status can only be read, but cannot be changed)
		BIT4	Disinfect
		BIT3	Reserved
BIT2	Reserved		
BIT1	Reserved		
BIT0	Reserved		
6 (PLC: 40007)	Curve selection	Bit8-Bit15	Climate Curve 1-9(zone 2)
		Bit0-Bit7	Climate Curve 1-9(zone 1)
7(PLC: 40008)	Forced water heating	0: Invalid 1: Forced on	TBH is the electric water tank heater. IBH1 and 2 are the hydraulic module's rear electric heater. IBH1 and 2 can be activated together.
8 (PLC: 40009)	Forced TBH	2: Forced off	TBH cannot be activated together with IBH1 and IBH2.
9(PLC: 40010)	Forced IBH1		
10(PLC: 40011)	t_SG_MAX		0-24 Hours
11(PLC: 40012)	T1S		Water temperature T1S is corresponding to the floor heating.(zone 1)
12(PLC: 40013)	T1S		Water temperature T1S is corresponding to the floor heating.(zone 2)
13(PLC: 40014)	t_ANTILOCK		Default setting: 5, range: 0-60 S(Available in Sphera A)
<p>Leaving water temperature T1s setting range instruction:  In cooling mode, T1S low temp setting range is 5-25°C;T1S high temp setting range is 18-25°C.  In heating mode, T1S low temp setting range is 25-55°C;T1S high temp setting range is 35-65°C.</p>			

8.1.2 When the wired controller is connected to the hydraulic module, the parameters of the whole unit can be checked:

The following address table can only use 03H function code(Read register).

**Whole unit parameter mapping address table**

<b>1) Running parameters</b>		
Register address	Description	Remarks
100(PLC: 40101)	Operating frequency	Compressor operating frequency in Hz
101(PLC: 40102)	Operating Mode	Outdoor unit's actual operating mode, 2: cooling, 3: heating, 0: off
102(PLC: 40103)	Fan Speed	Fan speed, in /min
103(PLC: 40104)	PMV openness	Openness of the outdoor unit's electronic expansion valve in P
104(PLC: 40105)	Water inlet temperature	TW_in, unit: °C
105(PLC: 40106)	Water outlet temperature	TW_out, unit: °C
106(PLC: 40107)	T3 Temperature	Condenser temperature, unit: °C
107(PLC: 40108)	T4 Temperature	Outdoor ambient temperature unit: °C
108(PLC: 40109)	Discharge temperature	Compressor discharge temperature Tp unit: °C
109(PLC: 40110)	Suction temperature	Compressor suction temperature Th, unit: °C
110(PLC: 40111)	T1	System total water outlet temperature (behind the auxiliary heater), unit: °C
111(PLC: 40112)	Tw2	Zone 2 water flow temperature, unit: °C
112(PLC: 40113)	T2	Refrigerant liquid side temperature, unit: °C
113(PLC: 40114)	T2B	Refrigerant gas side temperature, unit: °C
114(PLC: 40115)	Ta	Room temperature, unit: °C
115(PLC: 40116)	T5	Water tank temperature, unit: °C
116(PLC: 40117)	Pressure 1	Outdoor unit high pressure value, unit: kPa
117(PLC: 40118)	Pressure 2	Outdoor unit low pressure value, unit: kPa
118(PLC: 40119)	Outdoor unit current	Outdoor unit operating current, unit: A
119(PLC: 40120)	Outdoor unit voltage	Outdoor unit voltage, unit: V
120(PLC: 40121)	Tbt1	Tbt1, unit: °C
121(PLC: 40122)	Tbt2	Tbt2, unit: °C
122(PLC: 40123)	Compressor operation time	Compressor operating time in hour
123(PLC: 40124)	Unit capacity	0702 for 200 register is reserved. When it is 071x, data 4-30 means 4-30kW
124(PLC: 40125)	Current fault	Check the code table for detailed fault codes
125(PLC: 40126)	Fault 1	
126(PLC: 40127)	Fault 2	Check the code table for detailed fault codes.
127(PLC: 40128)	Fault 3	

128(PLC: 40129)	Status bit 1	BIT15	Request to send operation parameter, 1: request; 0: not request
		BIT14	Request to send software version, 1: request; 0: not request
		BIT13	Request to send SN code, 1: request; 0: not request
		BIT12	Reserved
		BIT11	EUV 1: free electricity; 0: judge by SG's signal
		BIT10	SG 1: normal electricity; 0: high price electricity (judge when EUV is 0)
		BIT9	Anti-freezing operation for water tank
		BIT8	Solar energy signal input
		BIT7	Cooling mode set by room thermostat
		BIT6	Heating mode set by room thermostat
		BIT5	Outdoor unit test mode mark
		BIT4	Remote On/Off (1: d8)
		BIT3	Oil return
		BIT2	Anti-freezing
		BIT1	Defrosting
BIT0	Reserved		
129(PLC: 40130)	Load output	BIT15	DEFROST
		BIT14	Auxiliary heat source
		BIT13	RUN
		BIT12	ALARM
		BIT11	Solar water pump
		BIT10	HEAT4
		BIT9	SV3
		BIT8	Mixed water pump P_c
		BIT7	Water return water P_d
		BIT6	External water pump P_o
		BIT5	SV2
		BIT4	SV1
		BIT3	Water pump PUMP_I
		BIT2	Electric heater TBH
		BIT1	Electric heater IBH2
BIT0	Electric heater IBH1		
130(PLC: 40131)	Software version	1~99 is the software version of hydronic module	
131(PLC: 40132)	Wired controller version No.	1~99 is the wired controller's version number.	

132(PLC: 40133)	Unit target frequency	Hz	
133(PLC: 40134)	DC bus current	Unit: A	
134(PLC: 40135)	DC bus voltage	The actual value/10, unit: V	
135( PLC: 40136)	TF module temperature	Feedback on outdoor unit, unit: °C	
136(PLC: 40137)	Climate curve T1S calculated value 1	The corresponding calculated T1S of zone 1	
137( PLC: 40138)	Climate curve T1S calculated value 2	The corresponding calculated T1S of zone 2	
138( PLC: 40139)	Water flow	The actual value*100, unit: m3/H	
139(PLC: 40140)	Limit scheme of outdoor unit current	Scheme value	
140(PLC: 40141)	Ability of Hyd raulic module	The actual value*100, unit: kW	
141(PLC: 40142)	Tsolar	Tsolar	
142(PLC: 40143)	Quantity of units in parallel	BIT1-BIT15	Respectively represent the online status of slaves unit 1-15
		BIT0	Reserved
143(PLC: 40144)	Higher bits for electricity consumption		
144(PLC: 40145)	Lower bits for electricity consumption		
145(PLC: 40146)	Higher bits for power output		
146(PLC: 40147)	Lower bits for power output		

Note :

1. When Tw2 unavailable, "25" would display in upper unit address 113.
2. When T2B unavailable, the wired controller would display"--" and "25" would display in upper unit address 113.
3. When Ta unavailable, "25" would display in upper unit address 114.
4. When E series without Tbt1- Tbt2, the wired controller would display"--" and "0" would display in upper unit addresses 120 and 121.



The following register address 200-208 can only use 03H(Read register) function code.Register address 209 and follows can use 03H, 06H (write single register), 10H (write multiple register).

2) Parameter setting		
Register address	Description	Remarks
200(PLC: 40201)	Home appliance type	The upper 8 bits are the types of home appliances: Air to water heat pump: 0x07 The middle 4 bits are product codes: 0x1* The lower 4 bits are sub-type: R32: 0x*2
201(PLC: 40202)	Temperature upper limit of T1S cooling	Lower 8 bits are for zone 1. higher 8 bits are for zone 2
202(PLC: 40203)	Temperature lower limit of T1S cooling	Lower 8 bits are for zone 1. higher 8 bits are for zone 2
203(PLC: 40204)	Temperature upper limit of T1S heating	Lower 8 bits are for zone 1. higher 8 bits are for zone 2
204(PLC: 40205)	Temperature lower limit of T1S heating	Lower 8 bits are for zone 1. higher 8 bits are for zone 2
205(PLC: 40206)	Temperature upper limit of TS setting	Protocol value = actual value * 2
206(PLC: 40207)	Temperature lower limit of TS setting	Protocol value = actual value * 2
207(PLC: 40208)	Temperature upper limit of water heating	
208(PLC: 40209)	Temperature lower limit of water heating	
209(PLC: 40210)	PUMP RUNNING TIME	DHW PUMP water return running time. It is five minutes by default and can be adjusted between 5 and 120 min at an interval of 1 min.
210(PLC: 40211)	Parameter setting 1	BIT15 Enable water heating BIT14 Supports water tank electric heater TBH(Read-only) BIT13 Supports disinfection BIT12 DHW PUMP, 1: supported; 0: not supported BIT11 Reserved BIT10 DHW pump is valid in disinfection mode BIT9 Enable cooling BIT8 T1S cooling high/low temperature settings(Read-only) BIT7 Enable heating BIT6 T1S heating high/low temperature settings(Read-only) BIT5 PUMPI silent mode, 1: valid, 0: invalid BIT4 Supports room temperature Sensor Ta BIT3 Supports room thermostat BIT2 Room thermostat BIT1 Dual Room Thermostat, 0: not supported;1: supported BIT0 0: room cooling/heating first, 1: water heating first

211(PLC: 40212)	Parameter setting 2	BIT15	ACS(Double water tank control) 1: Yes 0: No (read only)
		BIT14	M1M2 is used for AHS control 1: Yes 0: No
		BIT13	RT_Ta_PCNE(enable Temperature Collection Kit) 1: Yes 0: No
		BIT12	Tbt2 sensor is valid 1: Yes 0: No
		BIT11	Piping length selection 1: >10m 0: <10m
		BIT10	Solar energy input port 1: CN18 0: CN11
		BIT9	Solar energy kit enable 1: Yes 0: No
		BIT8	Define the port, 0=remote ON/OFF; 1=DHW heater
		BIT7	Smart grid, 0=NON; 1=YES
		BIT6	Tw2 sensor enable 0: None 1: Yes
		BIT5	Cooling high/low temperature setting T1S2 for Zone 2 (read only)
		BIT4	Heating high/low temperature setting T1S2 for Zone 2 (read only)
		BIT3	Double zone setting is valid
		BIT2	Ta sensor position 1: IDU 0: HMI
BIT1	Tbt1 sensor enable1: Yes 0: No		
BIT0	IBH/AHS installation position 1: buffer tank 0: pipe C		
212(PLC: 40213)	dT5_On	Default setting: 10° C, range: 1~30° C;	
213(PLC: 40214)	dT1S5	Default setting: 10° C, range: 5~40° C, setting interval: 1°	
214(PLC: 40215)	T_Interval_DHW	Default setting: 5 min, range: 5~5 min, setting interval: 1 min	
215(PLC: 40216)	T4DHWmax	Default setting: 43°C, range: 35~43°C, setting interval: 1°C	
216(PLC: 40217)	T4DHWmin	Default: -10° C, range: -25~30° C;	
217(PLC: 40218)	t_TBH_delay	Default setting: 30 min, range: 0~240 min, setting interval: 5 min	
218(PLC: 40219)	dT5S_TBH_off	Default setting: 5°C, range: 0~10°C, setting interval: 1°C	
219(PLC: 40220)	T4_TBH_on	Default setting: 5° C, range: -5~50° C;	
220(PLC: 40221)	T5s_DI	Temperature for the disinfection operation, range: 60~70 ° C, default setting: 65°C	

221(PLC: 40222)	t_DI_max	Maximum disinfection duration, range: 90~300 min, default setting: 210 min
222(PLC: 40223)	t_DI_hightemp	Disinfection high temperature duration, range: 5~60 min, default setting: 15 min
223(PLC: 40224)	t_interval_C	Time interval of compressor start-up in cooling mode; range: 5~5 min, default setting: 5 min
224(PLC: 40225)	dT1SC	Default setting: 5°C, range: 2~10°C, setting interval: 1°C
225(PLC: 40226)	dTSC	Default setting: 2°C, range: 1~10°C, setting interval: 1°C
226(PLC: 40227)	T4cmax	Default setting: 52°C, range: 35~52°C, setting interval: 1°C
227(PLC: 40228)	T4cmin	Default setting: 10°C, range: -5~25°C, setting interval: 1°C
228(PLC: 40229)	t_interval_H	Time interval of compressor start-up in the heating mode; range: 5~5 min, default setting: 5 min
229(PLC: 40230)	dT1SH	Default setting: 5°C, range: 2~20°C;
230(PLC: 40231)	dTSH	Default setting: 2°C, range: 1~10°C, setting interval: 1°C
231(PLC: 40232)	T4hmax	Default setting: 25°C, range: 20~35°C, setting interval: 1°C
232(PLC: 40233)	T4hmin	Default setting: -15°C, range: -25~30°C, Setting interval 1°C
233(PLC: 40234)	T4_IBH_on	Ambient temperature for enabling the hydraulic module auxiliary electric heating IBH, range: -15~10°C; default setting: -5°C
234(PLC: 40235)	dT1_IBH_on	Temperature return difference for enabling the hydraulic module auxiliary, range: 2~10°C; default setting: 5°C
235(PLC: 40236)	t_IBH_delay	Delay time of enabling the hydraulic module auxiliary electric heating IBH, range: 15~120 min; default setting: 30 min
237(PLC: 40238)	T4_AHS_on	The trigger ambient temperature for turning on AHS range: -15~30°C; default setting: -5°C
238(PLC: 40239)	dT1_AHS_on	The temperature difference between the heat pump's leaving water set temperature (T1S) and the heat, range: 2~20°C; default setting: 5°C
240(PLC: 40241)	t_AHS_delay	Delay time for enabling the external heater AHS, range: 5~120 min; default setting: 30 min

241(PLC: 40242)	t_DHWHP_max	Longest duration of water heating by the heat pump, range: 10~600 min, default setting: 90 min;
242(PLC: 40243)	t_DHWHP_restrict	Duration of limited water heating by the heat pump, range: 10~600 min, default setting: 30 min;
243(PLC: 40244)	T4autocmin	Default setting: 25°C, range: 20~29°C, setting interval: 1°C
244(PLC: 40245)	T4autohmax	Default setting: 17°C, range: 10~17°C, setting interval: 1°C
245(PLC: 40246)	T1S_H_A_H	Default setting: 25°C, range: 20~25°C, setting interval: 1°C
246(PLC: 40247)	T5S_H_A_DHW	In the holiday mode, setting of T1 in the water heating mode, range: 20~25°C, default setting: 25°C
247(PLC: 40248)	PER_START ratio	Range10-100, default setting10.Setting interval10
248(PLC: 40249)	TIME_ADJUST	Range1-60 default setting5
249(PLC: 40250)	dTbt2	Rrange0-50 default setting15
250(P LC: 40251)	IBH1 power	Range0-200, default setting0, unit: 100W
251(PLC: 40252)	IBH2 power	Range0-200, default setting0, unit: 100W
252(P LC: 40253)	TBH power	Range0-200, default setting0,unit: 100W
253(PLC: 40254)	Comfort parameter	Reserved, wrong address is reported when this register is queried
254(P LC: 40255)	Comfort parameter	Reserved, wrong address is reported when this register is queried
255(PLC: 40256)	t_DRYUP	Temperature rise day number, range: 4~15 days, default setting: 8 days
256(PLC: 40257)	t_HIGHPEAK	Drying day number, range: 3~7 days, default setting: 5 days
257(PLC: 40258)	t_DRYD	Temperature drop day number, range: 4~15 days, default setting: 5 days
258(PLC: 40259)	T_DRYPEAK	Highest drying temperature, range: 30~55°C, default setting: 45°C
259(PLC: 40260)	t_firstFH	Running time of floor heating for the first time, default setting: 72 hrs, range: 48-96 hrs
260(PLC: 40261)	T1S (first floor heating)	T1S of floor heating for the first time, range: 25~35°C, default setting: 25°C

261(PLC: 40262)	T1SetC1	Parameter of the ninth temperature curves for cooling mode, range: 5~25°C, default setting: 10°C
262(PLC: 40263)	T1SetC2	Parameter of the ninth temperature curves for cooling mode, range: 5~25°C, default setting: 16°C
263(PLC: 40264)	T4C1	Parameter of the ninth temperature curves for cooling mode, range: (-5)~46°C, default setting: 35°C
264(PLC: 40265)	T4C2	Parameter of the ninth temperature curves for cooling mode, range: (-5)~46°C, default setting: 25°C
265(PLC: 40266)	T1SetH1	Parameter of the ninth temperature curves for heating mode, range: 25~65°C, default setting: 35°C
266(PLC: 40267)	T1SetH2	Parameter of the ninth temperature curves for heating mode, range: 25~65°C, default setting: 28°C
267(PLC: 40268)	T4H1	Parameter of the ninth temperature curves for heating mode, range: (-25)~35°C, default setting: -5°C
268(PLC: 40269)	T4H2	Parameter of the ninth temperature curves for heating mode, range: (-25)~35°C, default setting: 7°C
269(PLC: 40270)	POWER INPUT LIMITATION	The type of power input limitation, 0=NON, 1~8=type 1~8, default: 0
270(P LC: 40271 )	HB: t_T4_FRESH_C	Range: 0.5~6 hour, setting interval: 0.5 hour, sending value=actual value*2
	LB: t_T4_FRESH_H	Range: 0.5~6 hour, setting interval: 0.5 hour, sending value=actual value*2
271(PLC: 40272)	T_PUMPI_DELAY	Range: 0.5~20 hour, setting interval: 0.5 hour, sending value=actual value*2
272(PLC: 40273)	EMISSION TYPE	Bit12-15: The type of zone 2 end for cooling mode
		Bit8-11: The type of zone 1 end for cooling mode
		Bit4-7: The type of zone 2 end for heating mode
		Bit0-3: The type of zone 1 end for heating mode

### 8.1.3 Error code

Unit	Register address	Content	Remarks
E0	1	Water flow fault(E8 displayed 3 times)	
E1	2	Phase loss or neutral wire and live wire are connected	Only applies to 3-phase models
E2	3	Communication fault between controller and hydraulic	
E3	4	Final outlet water temp. sensor(T1) fault	Sensor T1
E4	5	Water tank temp. sensor(T5) fault	Sensor T5
E5	6	The condenser outlet refrigerant temperature sensor(T3)	Sensor T3
E6	7	The ambient temperature sensor(T4) fault	Sensor T4
E7	8	Buffer tank up temp. sensor(Tbt1) fault	Sensor Tbt1
E8	9	Water flow failure	
E9	10	Compressor suction temp. sensor (Th) fault	Sensor Th
EA	11	Compressor discharge temp. sensor (Tp) fault	Sensor Tp
Eb	12	Solar temp. sensor(Tsolar) fault	
Ec	13	The balance tank low temp. sensor(Tbt2) fault	Sensor Tbt2
Ed	14	The plate exchanger water inlet temp. sensor(Tw in) fault	Sensor Tw in
EE	15	The main control board of hydraulic module EEPROM	
P0	20	Low pressure protection	
P1	21	High pressure protection	
P3	23	Compressor overcurrent protection	
P4	24	Compressor discharge temp. too high protection	
P5	25	High temperature difference protection between water inlet and water outlet of the plate heat exchanger	
P6	26	Inverter module protection	Displayed on user interface when any of L0, L1, L2, L4,L5, L7, L8 or L9 occur
Pb	31	Anti-freeze mode protection	
Pd	33	High temperature protection of refrigerant outlet temp. of condenser	
PP	38	Water inlet temperature is higher than water outlet in heating mode	
H0	39	Communication fault between main control board of hydraulic module and main control board PCB B	
H1	40	Communication fault between inverter module PCB A and main control board PCB B	
H2	41	The plate exchanger refrigerant outlet(liquid pipe) temp. sensor(T2) fault	Sensor T2
H3	42	The plate exchanger refrigerant outlet(gas pipe) temp. sensor(T2B) fault	Sensor T2B
H4	43	Three times L0/L1 protection	
H5	44	Room temp. sensor(Ta) fault	Sensor Ta
H6	45	DC fan motor fault	
H7	46	Main circuit voltage protection fault	

Unit	Register address	Content	Remarks
H8	47	Pressure sensor fault	
H9	48	Zone 2 water flow temp. sensor(Tw2) fault	Sensor TW2
HA	49	The plate heat exchanger water outlet temperature sensor(Tw_out) fault	Sensor Tw_out
Hb	50	3 times PP protection and Tw_out<7℃	
Hd	52	Communication fault between master unit and slave unit(in parallel)	
HE	53	Communication fault between main board of hydraulic module and Ta/room thermostat transfer PCB	
HF	54	Inverter module board EE PROM fault	
HH	55	H6 display 10 times in 120 minutes	
HP	57	Low pressure protection (Pe<0.6) occurred 3 times in 1 hour in cooling mode	
C7	65	High temp. protection of inverter module	
bH	112	PED PCB fault	
F1	116	DC bus low voltage protection	
L0	134	DC compressor inverter module fault	
L1	135	DC bus low voltage protection(from inverter module mostly when compressor running)	
L2	136	DC bus high voltage protection from DC driver	
L4	138	MCE fault	
L5	139	Zero speed protection	
L7	141	Phase sequence fault	
L8	142	Compressor frequency variation greater than 15Hz within one second protection	
L9	143	Actual compressor frequency differs from target frequency by more than 15Hz protection	

# dzitsu

**EUROFRED**  
*being efficient*

Eurofred S.A.  
Marqués de Sentmenat 97  
08029 Barcelona  
[www.eurofred.es](http://www.eurofred.es)