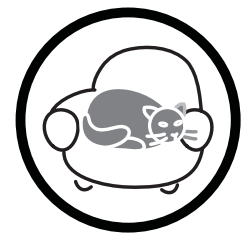
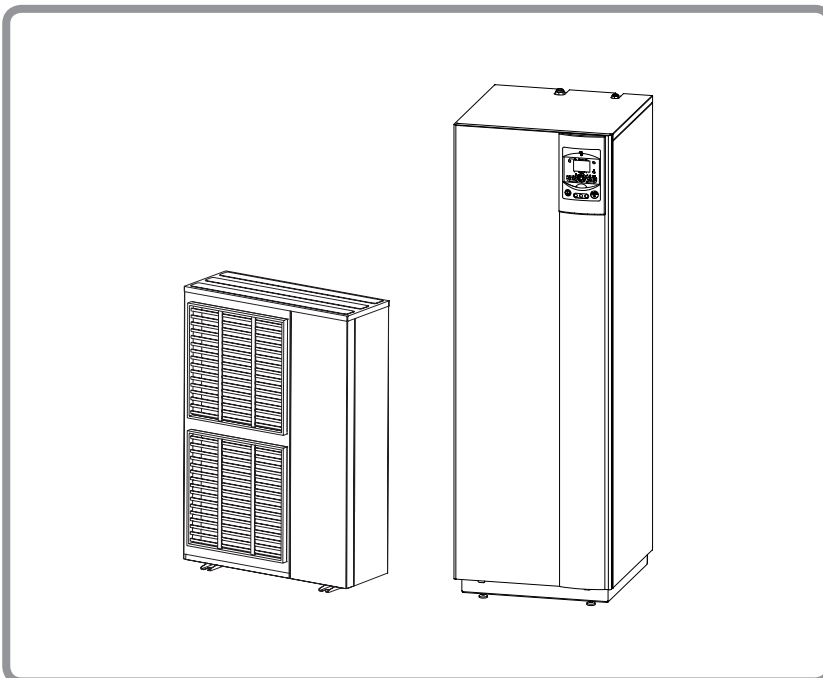
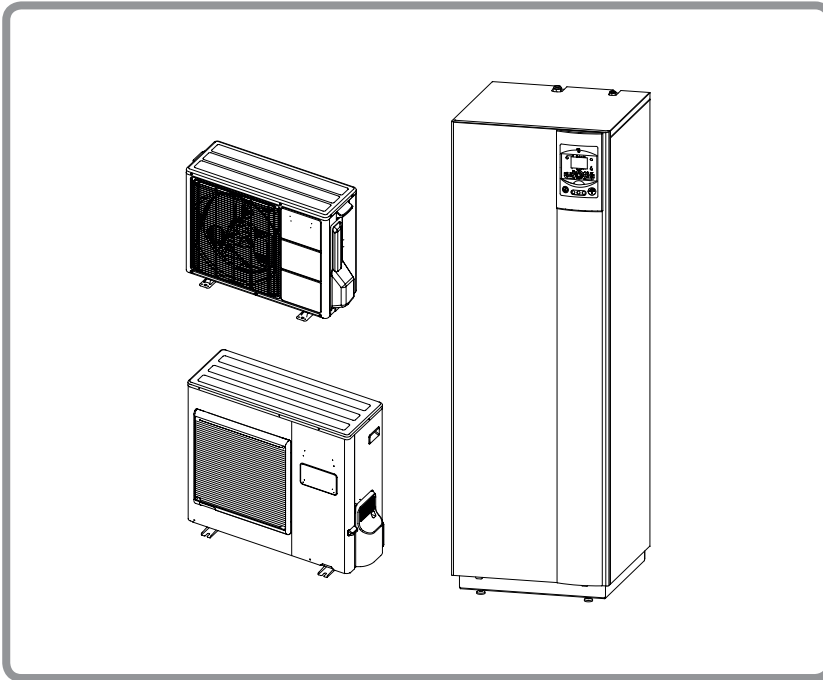


## Air to Water Heat Pump

### Split integrated DHW type



**Operation manual  
intended for professionals  
and end users.**

To be saved for  
future consultation

**Packing list**

<i>Heat Pump</i>	<i>Outdoor Unit</i>	<i>Hydraulic Unit</i>
<i>Model</i>	<i>Reference</i>	<i>Reference</i>
Waterstage Comfort Integrated DHW 5	WOYA060LFCA	WGYA050DG6
Waterstage Comfort Integrated DHW 6	WOYA060LFCA	WGYA100DG6
Waterstage Comfort Integrated DHW 8	WOYA080LFCA	
Waterstage Comfort Integrated DHW 10	WOYA100LFTA	
Waterstage High Power Integrated DHW 11 single phase	WOYG112LHT WOYG112LCTA	WGYG140DG6
Waterstage High Power Integrated DHW 14 single phase	WOYG140LCTA	WGYK160DG9
Waterstage High Power Integrated DHW 11 3-phase	WOYK112LCTA	
Waterstage High Power Integrated DHW 14 3-phase	WOYK140LCTA	
Waterstage High Power Integrated DHW 16 3-phase	WOYK160LCTA	

**Contents**

**Safety instructions . . . . . 3**

**Overall view of the installation . . . . . 4**

Precautions and warnings regarding your installation . . . . . 4

    The outdoor unit . . . . . 4

    The hydraulic unit . . . . . 4

    Control system . . . . . 4

    The radiators . . . . . 4

    Floor-heating systems . . . . . 4

    Fan convectors / Dynamic radiators with integrated control system . . . . . 4

    Domestic hot water (DHW) . . . . . 4

    End of life of the device . . . . . 5

    Overall view of the installation . . . . . 5

**Operation of the installation. . . . . 6**

User interface, Room control unit and Room thermostat (option) . . . . . 6

Description of the display . . . . . 8

Appliance start up . . . . . 9

Quick start-up . . . . . 9

Setting the time . . . . . 10

Structure of the "End user" control menu . . . . . 11

Parametering the setting . . . . . 12

    General . . . . . 12

    Setting parameters . . . . . 12

    List of "End user" settings . . . . . 12

Information display . . . . . 18

Details . . . . . 18

Operation of the DHW system. . . . . 19

Selecting cooling mode . . . . . 19

Pilot wire (if kit regulation extension AVS 55) . . . . . 19

Telephone modem (if Regulation extension kit AVS 55) . . . . . 19

Configuring room control unit (option) . . . . . 19

**Maintenance . . . . . 20**

Regular checks . . . . . 20

Checking the outdoor unit . . . . . 20

Domestic hot water tank . . . . . 20

**ERP Comfort values . . . . . 20**

**ERP High power values . . . . . 22**

# 1 Safety instructions

---

Please comply with the following instructions in order to avoid any risk of injury or inappropriate use of the appliance.

## • Start-up

- ☞ Do not switch the appliance on until every fillings have been done.
- ☞ Do not try to install this appliance yourself.
- ☞ This heat pump requires an appropriately qualified person to install it.
- ☞ The installation must always be connected to the Earth and fitted with a protective circuit breaker.
- ☞ Do not modify the electricity supply.
- ☞ The appliances are not fireproof and should therefore not be installed in a potentially explosive atmosphere.

## • Use

- ☞ Do not let children insert foreign bodies into the fan protection grill or climb on top of the outdoor unit. The fins on the air exchanger are extremely fine and cause cuts.
- ☞ Nothing should obstruct the air circulation through the evaporator and from the fan.
- ☞ The outdoor unit must only be installed outdoor (outdoors). If a shelter is required, it must have broad openings on the 4 walls and observe the installation clearances (see with your installer).
- ☞ Do not climb on the top of the outdoor unit.
- ☞ The room in which the appliance is operating must be correctly ventilated in order to prevent any loss of oxygen if there is an escape of refrigerant gas.
- ☞ Consult your Installer before making any changes or modifications to the premises where the appliance is installed.
- ☞ Do not place any heat source under the room control unit.

## • Maintenance

- ☞ Do not try to repair this appliance yourself.
- ☞ This appliance does not contain any components capable of being repaired by the user himself. Removing one or other of the covers can expose you to dangerous electrical voltages.
- ☞ In any case, switching off the current is not sufficient to protect you from any external electrical shocks (capacitors).
- ☞ Do not open the outdoor unit or the hydraulic unit while they are operating.
- ☞ Switch off the power supply if there are any abnormal noises, smells or smoke coming from the appliance and contact your installer.
- ☞ Switch off the power to the appliance before you clean it.
- ☞ Do not use aggressive cleaning liquid or solvents to clean the body work.
- ☞ Do not use a pressure washer to clean the outdoor unit. This could damage the air exchanger and the water might penetrate into the electrical circuits.

## 2 Overall view of the installation

---

### 2.1 Precautions and warnings regarding your installation.

#### 2.1.1 The outdoor unit

The outdoor unit contains the equipment for capturing energy from the ambient air.

Your installer has placed this unit in a location that enables it to operate in an optimum manner.

Nothing should obstruct the air circulation through the evaporator and from the fan.

The water that the air contains condenses and flows from the external unit.

In cold periods, this water freezes in contact with the exchanger and is drained away by regular defrosting cycles. The control system automatically controls the defrosting cycle, whose operation can lead to the quite normal emission of steam.

#### 2.1.2 The hydraulic unit

The hydraulic unit contains the heat pump complete control system, in charge of controlling the heating comfort level and the production of domestic hot water.

The heat pump is equipped with an electrical back-up system, which is designed to provide additional heat during the coldest periods

#### 2.1.3 Control system

Your installer has carefully adjusted your installation. Do not modify setting parameters without his agreement. If in doubt, do not hesitate to contact him.

The control system for your heating system is designed in flow temperature for the water based on the outdoor temperature (water control).

The installation of a room thermostat (option) allows to improve operation of the regulation (the influence of the room temperature is taken into account).

#### 2.1.4 The radiators

To ensure the function of the regulation with room influence, it's necessary that the room in which the room thermostat is installed has no thermostatic valve or that they must be completely open.

#### 2.1.5 Floor-heating systems

New floor-heating systems require to be initially heated slowly to avoid any problems with cracking. Check with your installer that this initial heating procedure has indeed been performed before using your heating system freely.

The great stability in a regulation system for floor-heating systems avoids sharp differences in temperature. However, this stability involves a reaction time of the order of several hours, (approx 6 hours).

Any changes to the setting must be made slowly, leaving the installation time to react. Adjusting the system to exaggerated setting or in an untimely manner always results in significant temperature fluctuations during course of the day.

Similarly if your dwelling has a floor-heating system, do not reduce the heating or switch it off if you will be absent for a short period. The reheating period is always quite long (approx 6 hours).

#### 2.1.6 Fan convectors / Dynamic radiators with integrated control system

Do not use a room sensor in the area.

#### 2.1.7 Domestic hot water (DHW)

When the DHW production is required, the heat pump adapts to this demand with higher priority.

No space heating is produced while the domestic hot water is being prepared.

Domestic hot water (DHW) is produced by the heat pump and then topped up, if necessary, by electrical backup heating or the boiler.

To ensure a DHW setting over 45°C, the electrical back-up heating or the boiler must be left on (Optional boiler connection kit).

The electrical back-up heating enables anti-legionella cycles to be conducted efficiently.

## 2.2 End of life of the device

Disassembly and recycling shall be handled by a qualified body. Wild disposal is strickly prohibited.

At the end-of-life of the equipment, please contact your installer or any local representant to proceed to disassembly and recycling.

## 2.3 Overall view of the installation

Your heat pump has been configured by your installer. It is composed of the following main elements:

- The outdoor unit is positioned, as its name indicates, outdoor your dwelling and extracts energy from the outdoor air.
- The hydraulic unit positioned in your boiler room, cellar, garage or even your kitchen, transfers the energy to the heating circuit (and the domestic hot water).
- The outdoor sensor detects the outdoor temperature.

*Optional equipment:*

- Room thermostat.
- Room control unit.

Heat pumps are systems that can be connected to any form of **low temperature heat distribution systems** : the heat captured by the heat pump can therefore be used in different ways:

- Floor-heating systems.
- Radiators or fan coil heaters.
- Domestic hot water (DHW).

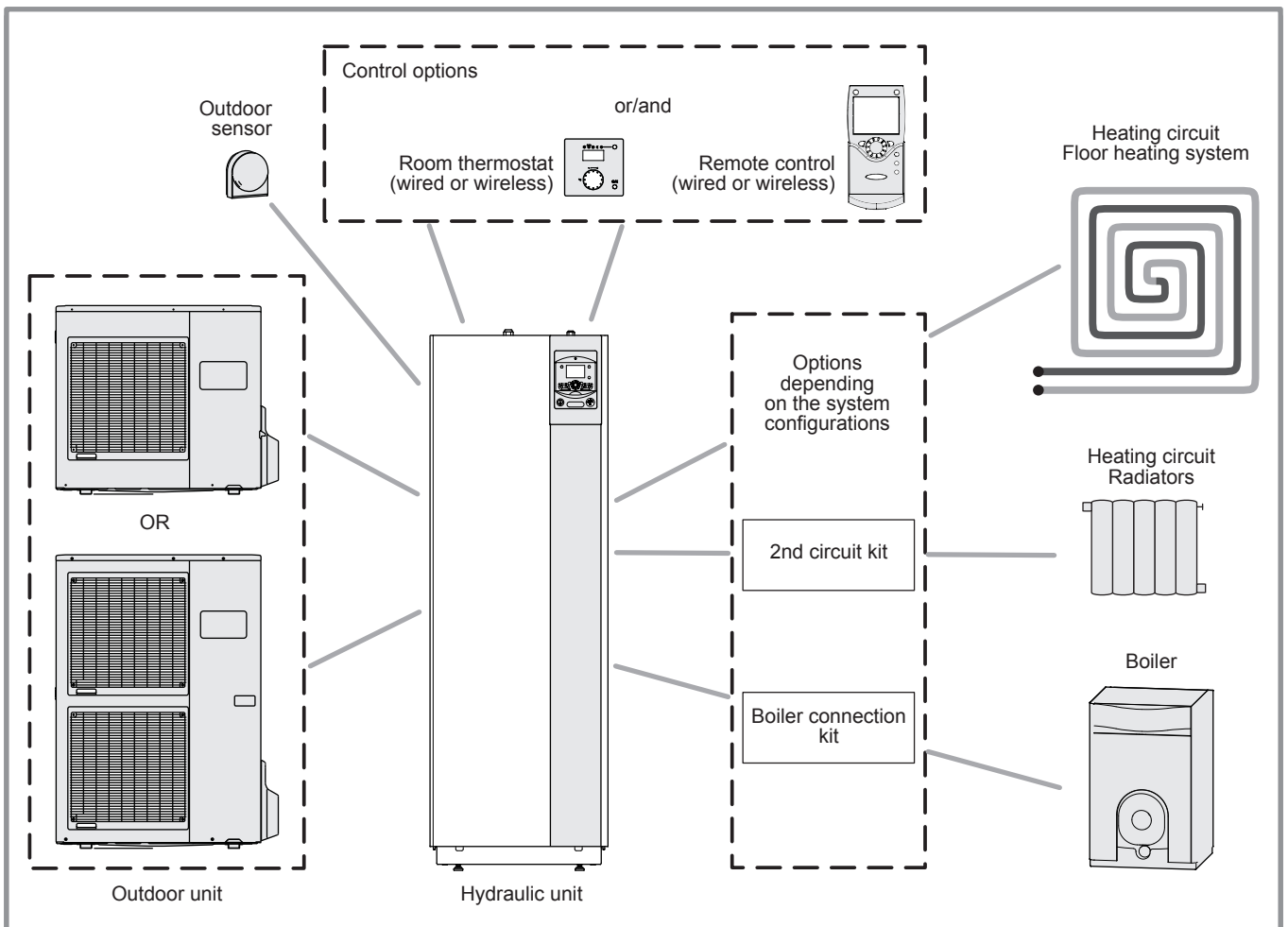


figure 1 - Overall view of the configuration of a complete installation

### 3 Operation of the installation

#### 3.1 User interface, Room control unit and Room thermostat (option)

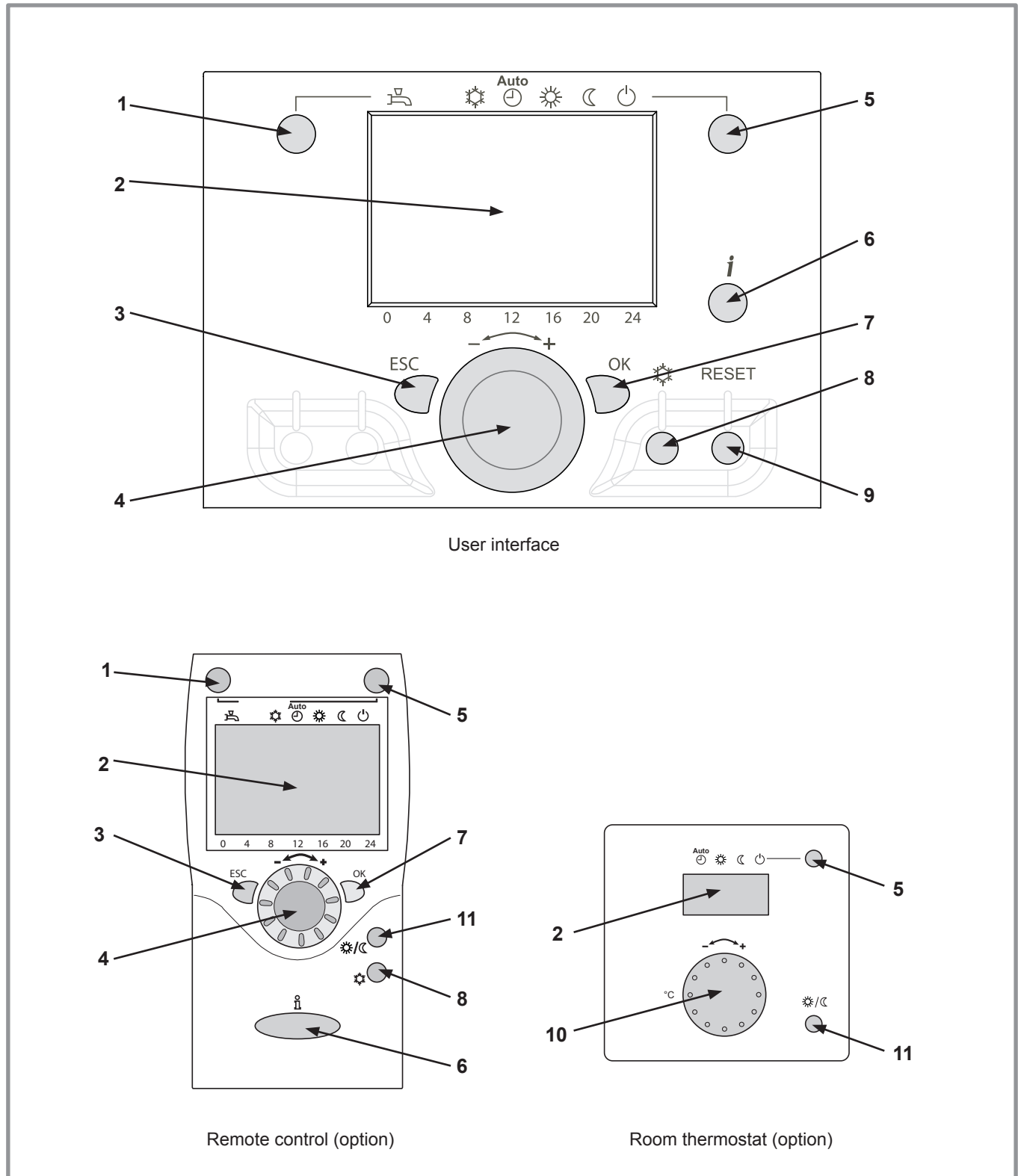












figure 2 -

Ref.	Functions	- Definitions
1	Selecting of the DHW operating mode (Domestic hot water).   On  Off	<ul style="list-style-type: none"> <li>- <b>On:</b> Production of DHW according to the time program.</li> <li>- <b>Off:</b> Preparing the domestic hot water for stopping with the anti-frost function active.</li> <li>- <b>Manual start button:</b> Hold down the DHW key for 3 seconds. Switch from "reduced" to "comfort" until the next time the ECS timer switches over.</li> </ul>
2	Digital display.	<ul style="list-style-type: none"> <li>- Operating control. Readout of the current temperature, of the heating mode and of any faults  .</li> <li>- View the settings.</li> </ul>
3	Exit "ESC".	<ul style="list-style-type: none"> <li>- Quit the menu.</li> </ul>
4	Navigation and setting.	<ul style="list-style-type: none"> <li>- Selecting the menu.</li> <li>- Setting parameters.</li> <li>- Adjusting the ambient temperature setpoint.</li> </ul>
5	Selecting the heating mode.	<ul style="list-style-type: none"> <li>-  Heating operating according to the heating program (Summer/winter mode switchover is automatic).</li> <li>-  Constant comfort temperature.</li> <li>-  Constant reduced temperature.</li> <li>-  Stand-by mode with anti-frost protection (Provided that the heat pump's electrical power supply is not interrupted).</li> </ul>
6	Information display.	<ul style="list-style-type: none"> <li>- Various data (see <a href="#">page 18</a>).</li> <li>-  Reading error codes (see <a href="#">Installation and operating manual</a>).</li> <li>-  Information concerning maintenance, special mode.</li> </ul>
7	Confirm "OK".	<ul style="list-style-type: none"> <li>- Input into the selected menu.</li> <li>- Confirmation of the parameter settings.</li> <li>- Confirmation of the adjustment to the comfort temp. setting.</li> </ul>
8	Selecting cooling mode.	<ul style="list-style-type: none"> <li>- If the installation is fitted with the cooling kit:</li> <li>-  Cooling operating according to the heating program (Summer/winter mode switchover is automatic).</li> </ul>
9	RESET button (Brief press)	<ul style="list-style-type: none"> <li>- Reinitialising the parameters and cancelling error messages. <b>Do not use during normal operation.</b></li> </ul>
10	Control knob.	<ul style="list-style-type: none"> <li>- Adjusting the ambient temperature setpoint.</li> </ul>
11	Presence key.	<ul style="list-style-type: none"> <li>- Comfort / Reduced switchover.</li> </ul>





### 3.3 Appliance start up

- The installation and 1st start up of the appliance must be done by a qualified installer. That person will also give you instructions on starting and running the appliance.
- Ensure that the installation is fully filled with water and has been correctly bled and that there is a sufficient pressure of 1,5 to 2 bars on the manometer (ref. 2, figure 5).
- Close the installation's main circuit breaker.  
In winter, so that the compressor can be preheated, close the installation's main circuit breaker (outdoor unit's power supply) some hours before pressing the on/off button.

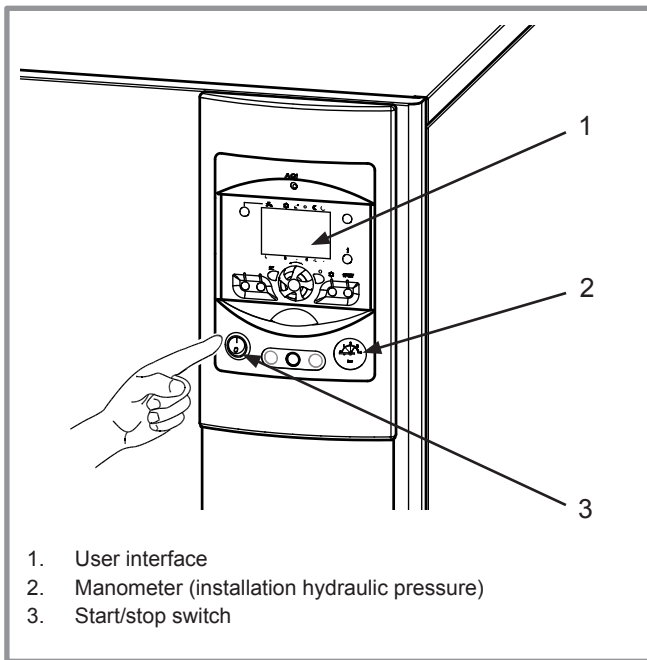


figure 5 - Start-up

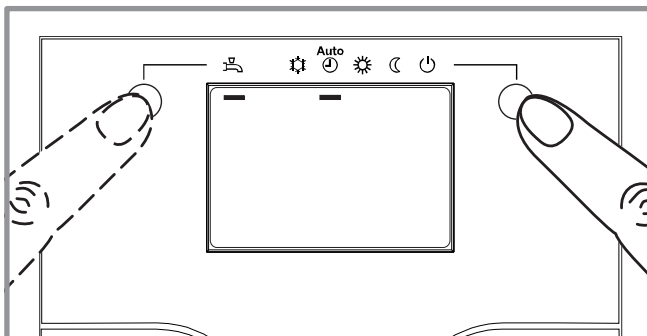


figure 6 - Selecting the heating mode AUTO and Select the DHW mode

### 3.4 Quick start-up

Once your installer has started your installation for the first time:

- Engage the start/stop switch.  
During the regulator initialisation phase, the display shows all the symbols and then "Data, update" and then "State heat pump".
- Select the "AUTO" heating mode (figure 6).
- Select the DHW mode (figure 6).
- Adjust the date and time if necessary (figure 7).

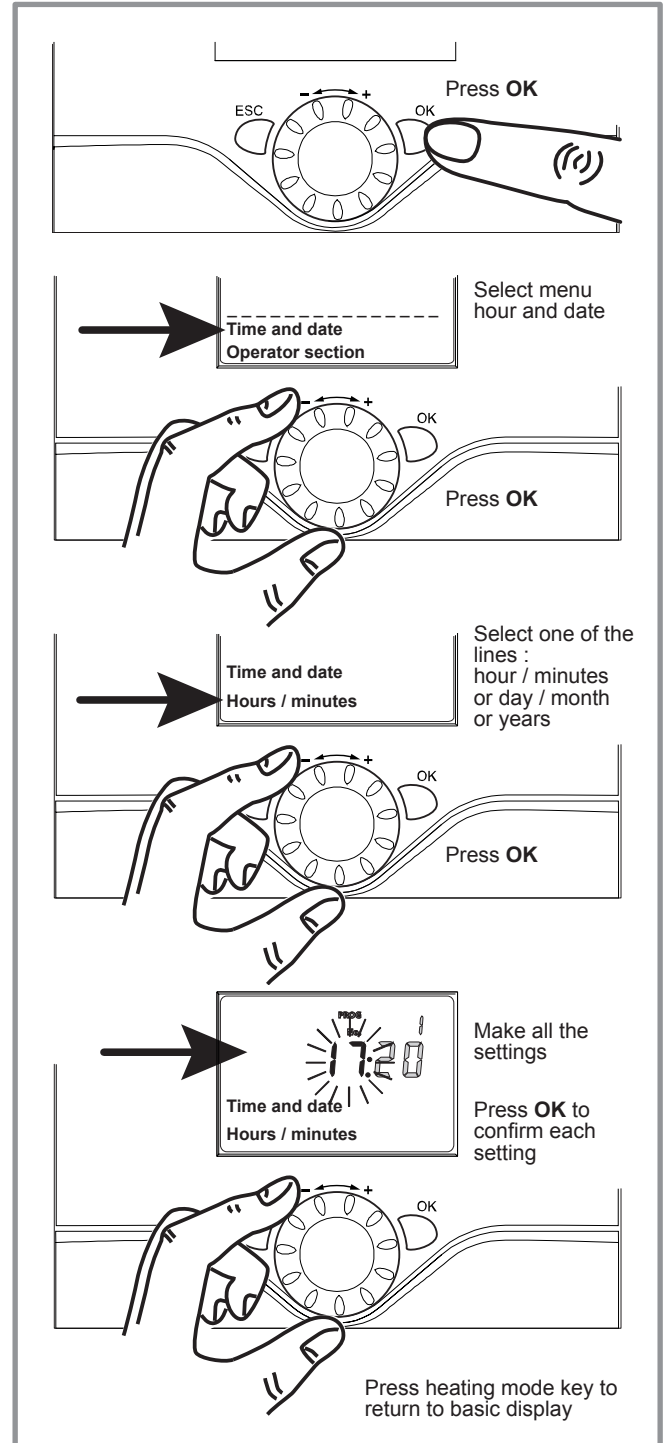


figure 7 - Setting the time and the date

### 3.5 Setting the time

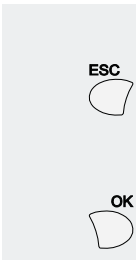
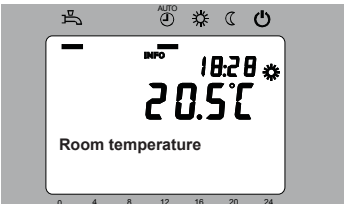
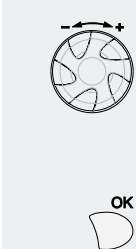
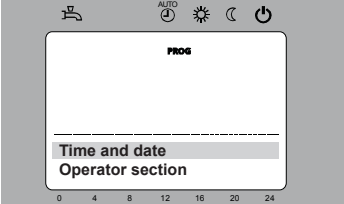
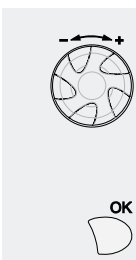
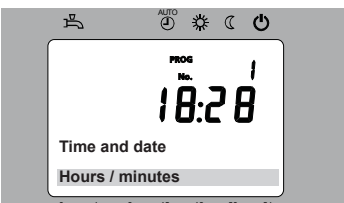

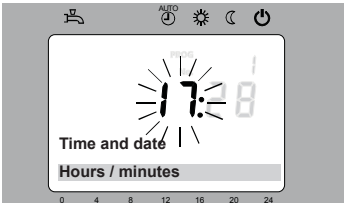
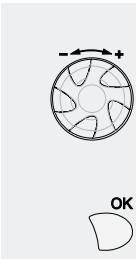
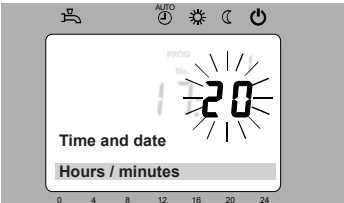
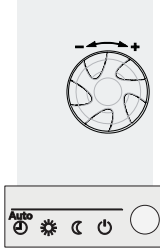
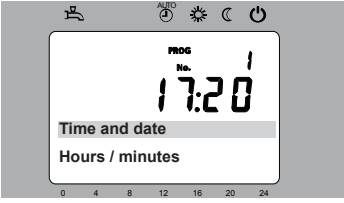
Keys	Display example	Description
<p>1</p> 		<p>Basic display</p> <p>If the basic display is not shown, press <b>ESC</b> to return to it</p> <p>Press <b>OK</b> to confirm.</p>
<p>2</p> 		<p>Turn the knob Select menu hour and date</p> <p>Press <b>OK</b> to confirm.</p>
<p>3</p> 		<p>Turn the knob</p> <p>Select line 1 Hours / minutes</p> <p>Press <b>OK</b> to confirm.</p>
<p>4</p> 		<p>The hour display flashes</p> <p>Turn the knob to set the time</p> <p>Press <b>OK</b> to confirm.</p>
<p>5</p> 		<p>The minutes display flashes</p> <p>Turn the knob to set the minutes</p> <p>Press <b>OK</b> to confirm.</p>
<p>6</p> 		<p>The setting are recorded</p> <p>Turn the knob to make other settings</p> <p>or</p> <p>Press heating mode key to return to basic display.</p>

figure 8 -

### 3.6 Structure of the "End user" control menu

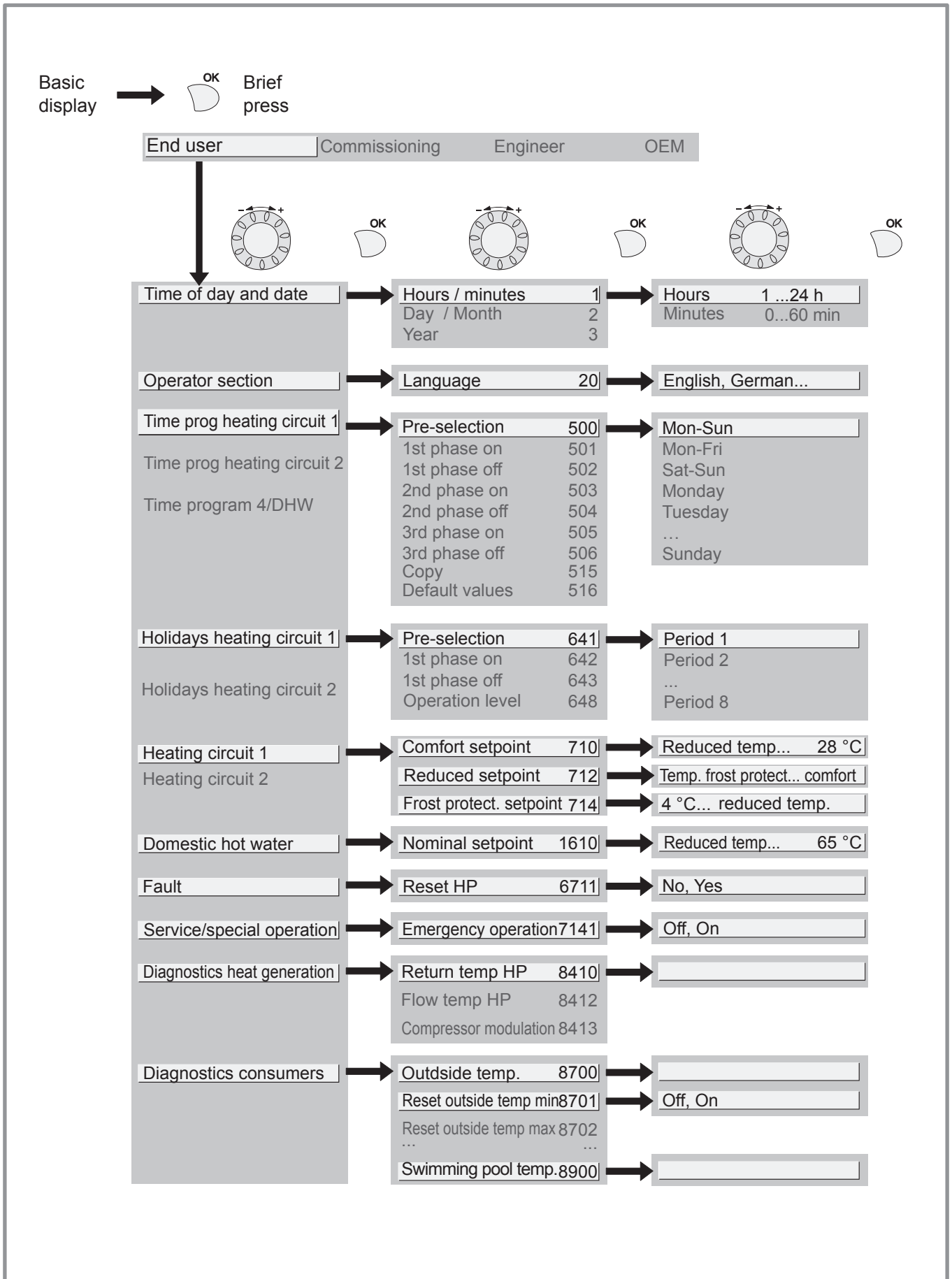


figure 9 -

### 3.7 Parametering the setting

#### 3.7.1 General

Only the parameters accessible to levels:

End user

Are described in this document.

The parameters accessible at level:

Commissioning

Engineer

... are described in the document reserved for these professional specialists. **Do not make any modifications to these parameters without advice from these professional specialists. Incorrect use of any kind may result in serious malfunctioning.**

#### 3.7.2 Setting parameters

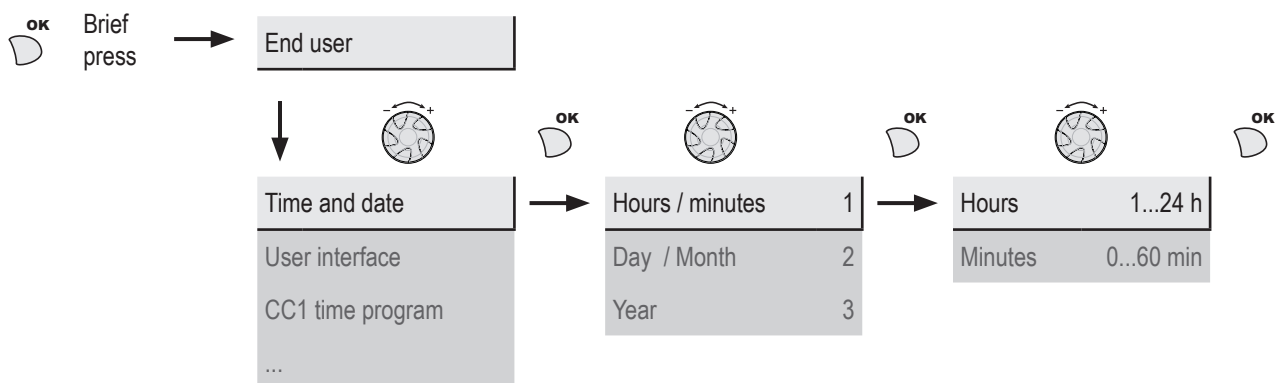
With the screen on basic display.

- Press **OK**.

Once in "End user" level.

- Scroll the menu list.
- Choose the desired menu.
- Scroll the function lines.
- Choose the desired line.
- Adjust the parameter.
- Check the setting by pressing **OK**.
  
- To return the menu, press **ESC**.

If no setting is made for 8 minutes, the screen returns automatically to the basic display.



#### 3.7.3 List of "End user" settings

Line	Function	Setting range or display	Setting increment	Basic setting
<b>Time of day and date</b>				
1	Hours / Minutes	00:00... 23:59	1	
2	Day / Month	01.01... 31.12	1	
3	Year	1900... 2099	1	
<b>Operator Section</b>				
20	Language	English, Français, Italiano, Nederlands...		<b>English</b>

<i>Line</i>	<i>Function</i>	<i>Setting range or display</i>	<i>Setting increment</i>	<i>Basic setting</i>
<b>Time program heating / cooling, circuit 1</b>				
500	Pre-selection (Day / Week)	Mon-Sun, Mon-Fri, Sat-Sun, Monday, Tuesday, ...		<b>Mon-Sun</b>
501	1st phase On (start)	00:00... --:--	10 min	<b>6:00</b>
502	1st phase Off (end)	00:00... --:--	10 min	<b>22:00</b>
503	2nd phase On (start)	00:00... --:--	10 min	--:--
504	2nd phase Off (end)	00:00... --:--	10 min	--:--
505	3rd phase On (start)	00:00... --:--	10 min	--:--
506	3rd phase Off (end)	00:00... --:--	10 min	--:--
516	Default values, Circuit 1	No, Yes		<b>No</b>
Yes + OK: The default values memorised in the regulator replace and cancel the customised heating programs. Your customised settings are therefore lost.				
<b>Time program heating / cooling, circuit 2</b>				
Only with the 2nd circuit kit option.				
520	Pre-selection (Day / Week)	Mon-Sun, Mon-Fri, Sat-Sun, Monday, Tuesday, ...		<b>Mon-Sun</b>
521	1st phase On (start)	00:00... --:--	10 min	<b>6:00</b>
522	1st phase Off (end)	00:00... --:--	10 min	<b>22:00</b>
523	2nd phase On (start)	00:00... --:--	10 min	--:--
524	2nd phase Off (end)	00:00... --:--	10 min	--:--
525	3rd phase On (start)	00:00... --:--	10 min	--:--
526	3rd phase Off (end)	00:00... --:--	10 min	--:--
536	Default values, Circuit 2	No, Yes		<b>No</b>
Yes + OK: The default values memorised in the regulator replace and cancel the customised heating programs. Your customised settings are therefore lost.				
<b>Time program 4 / DHW</b>				
560	Pre-selection (Day / Week)	Mon-Sun, Mon-Fri, Sat-Sun, Monday, Tuesday, ...		<b>Mon-Sun</b>
561	1st phase On (start)	00:00... --:--	10 min	<b>00:00</b>
562	1st phase Off (end)	00:00... --:--	10 min	<b>05:00</b>
563	2nd phase On (start)	00:00... --:--	10 min	<b>14:30</b>
564	2nd phase Off (end)	00:00... --:--	10 min	<b>17:00</b>
565	3rd phase On (start)	00:00... --:--	10 min	--:--
566	3rd phase Off (end)	00:00... --:--	10 min	--:--
576	Default values	No, Yes		<b>No</b>
Yes + OK: The default values memorised in the regulator replace and cancel the customised heating programs. Your customised settings are therefore lost.				
<b>Holidays, heating circuit 1</b> (For the Holiday program is active, the heating mode should be on AUTO).				
641	Preselection	Period 1 to 8		<b>Period 1</b>
642	Period Start (Day / Month)	01.01... 31.12	1	
643	Period End (Day / Month)	01.01... 31.12	1	
648	Operating level	Frost protection, Reduced		<b>Frost protection</b>

<i>Line</i>	<i>Function</i>	<i>Setting range or display</i>	<i>Setting increment</i>	<i>Basic setting</i>
<b>Holidays, heating circuit 2</b> (For the Holiday program is active, the heating mode should be on AUTO).				
If the installation consists of 2 heating circuits (Only with the 2nd circuit kit option).				
651	Preselection	Period 1 to 8		<b>Period 1</b>
652	Period Start (Day / Month)	01.01... 31.12	1	
653	Period End (Day / Month)	01.01... 31.12	1	
658	Operating level	Frost protection, Reduced		<b>Frost protection</b>
<b>Heating adjustment, circuit 1</b>				
710	Comfort setpoint	Reduced setpoint... Comfort setpoint maximum	0,5 °C	<b>20 °C</b>
712	Reduced setpoint	Frost protection setpoint... Comfort setpoint	0,5 °C	<b>19 °C</b>
714	Frost protection setpoint	4 °C... Reduced setpoint	0,5 °C	<b>8 °C</b>
<b>Cooling circuit 1</b>				
If the installation is fitted with the cooling kit (Only with the cooling kit option).				
901	Operating mode	Protection, Automatic, Reduced, Comfort		<b>Protection</b>
902	Comfort cooling setpoint	17... 40 °C	0,5 °C	<b>24 °C</b>
903	Reduced setpoint	5... 40°C		<b>26 °C</b>
<b>Heating adjustment, Circuit 2</b>				
Only with the 2nd circuit kit option (If the installation consists of 2 heating circuits).				
1010	Comfort setpoint	Reduced setpoint... Comfort setpoint maximum	0,5 °C	<b>20 °C</b>
1012	Reduced setpoint	Frost protection setpoint... Comfort setpoint	0,5 °C	<b>19 °C</b>
1014	Frost protection setpoint	4 °C... Reduced setpoint	0,5 °C	<b>8 °C</b>
<b>Cooling circuit 2</b>				
If the installation is fitted with the cooling kit (Only with the cooling kit option).				
1201	Operating mode	Protection, Automatic, Reduced, Comfort		<b>Protection</b>
1202	Comfort cooling setpoint	17... 40 °C	0,5 °C	<b>24 °C</b>
1203	Reduced setpoint	5... 40°C		<b>26 °C</b>
<b>Domestic hot water</b>				
1600	Operating mode	Off, On, Eco		<b>On</b>
1610	Nominal setpoint	Reduced setpoint (line 1612)... 65 °C	1	<b>55 °C</b>
The backup electrical system is required to reach this level.				
1612	Reduced setting	8 °C... Nominal setting (line 1610)	1	<b>40 °C</b>
<b>Swimming pool (Only with swimming pool kit option)</b>				
2055	Setpoint solar heating	8... 80 °C		<b>26 °C</b>
2056	Setpoint source heating	8... 35 °C		<b>22 °C</b>

<i>Line</i>	<i>Function</i>	<i>Setting range or display</i>	<i>Setting increment</i>	<i>Basic setting</i>
<b>Energy meter</b>				
3095 --> 3110 : Not used				
3113	Energy brought in		Kwh	--
<b>Cumulation of total consumed electrical energy.</b> Electrical energy consumed = Electrical energy absorbed by outdoor unit + electric energy absorbed by the heating electrical backup and / or DHW electrical backup (if installed).				
3121 --> 3123 : Not used				
3124	Energy brought in heating 1 (N - 1)		Kwh	--
3125	Energy brought in DHW 1		Kwh	--
3126	Energy brought in cooling 1		Kwh	--
3128 --> 3130 : Not used				
3131	Energy brought in heating 2 (N - 2)		Kwh	--
3132	Energy brought in DHW 2		Kwh	--
3133	Energy brought in cooling 2		Kwh	--
3135 --> 3137 : Not used				
3138	Energy brought in heating 3 (N - 3)		Kwh	--
3139	Energy brought in DHW 3		Kwh	--
3140	Energy brought in cooling 3		Kwh	--
3142 --> 3144 : Not used				
3145	Energy brought in heating 4 (N - 4)		Kwh	--
3146	Energy brought in DHW 4		Kwh	--
3147	Energy brought in cooling 4		Kwh	--
3149 --> 3151 : Not used				
3152	Energy brought in heating 5 (N - 5)		Kwh	--
3153	Energy brought in DHW 5		Kwh	--
3154	Energy brought in cooling 5		Kwh	--
3156 --> 3158 : Not used				
3159	Energy brought in heating 6 (N - 6)		Kwh	--
3160	Energy brought in DHW 6		Kwh	--
3161	Energy brought in cooling 6		Kwh	--
3163 --> 3165 : Not used				
3166	Energy brought in heating 7 (N - 7)		Kwh	--
3167	Energy brought in DHW 7		Kwh	--
3168	Energy brought in cooling 7		Kwh	--
3170 --> 3172 : Not used				
3173	Energy brought in heating 8 (N - 8)		Kwh	--
3174	Energy brought in DHW 8		Kwh	--
3175	Energy brought in cooling 8		Kwh	--

**Note: "Energy" Counters increment as of 1 July each year.**

<b>Line</b>	<b>Function</b>	<b>Setting range or display</b>	<b>Setting increment</b>	<b>Basic setting</b>
3177 --> 3179 : Not used				
3180	Energy brought in heating 9 (N - 9)		Kwh	--
3181	Energy brought in DHW 9		Kwh	--
3182	Energy brought in cooling 9		Kwh	--
3184 --> 3186 : Not used				
3187	Energy brought in heating 10 (N - 10)		Kwh	--
3188	Energy brought in DHW 10		Kwh	--
3189	Energy brought in cooling 10		Kwh	--
3190 --> 3267 : Not used				
<b>Error</b>				
6711	Reset HP	No, Yes		<b>No</b>
<b>Maintenance / special regime</b>				
7141	Emergency operation	Off, On		<b>Off</b>
	Off: Heat pump functions normally (with boosters if necessary). On: Heat pump uses the electric boost system or the boiler connection. Use the "On" position only in Assist mode or Test mode: may result in high power bills.			
<b>Generator diagnosis</b>				
8410	Return temp HP	0... 140 °C		--
	Setpoint (flow) HP			--
8412	Flow temp HP	0... 140 °C		--
	Setpoint (flow) HP			--
8413	Compressor modulation	0... 100%		--
<b>Diagnostics consumers</b>				
8700	Outdoor temperature	-50... 50 °C		--
8701	Outdoor temp min Reset ? (no, yes)	-50... 50 °C		<b>50 °C</b>
8702	Outdoor temp max Reset ? (no, yes)	-50... 50 °C		<b>-50 °C</b>
8740	Room temperature 1	0... 50 °C		--
	Room setting 1			<b>20 °C</b>
8743	Flow temperature 1	0... 140 °C		--
	Flow temperature setpoint 1			--
8756	Cooling flow temperature 1	0... 140 °C		--
	Cooling flow temperature setpoint 1			--
8830	DHW (domestic hot water) temperature	0... 140 °C		--
	DHW temperature setpoint			<b>50 °C</b>






### 3.8 Information display

Various data can be displayed by pressing the info button.


Depending on the type of unit, configuration and operating state, some of the info lines listed below may not appear.

- Possible error messages:

The display shows the "Bell" symbol  .

☞ **Consult your heating technician.**

- Service messages ; Special mode messages:

The display shows the "Key" symbol  .

☞ **Consult your heating technician.**

- Various data (see below).

<i>Designation</i>	<i>Line</i>
Floor drying current setpoint .	-
Current drying day.	-
Terminated drying days.	-
State heat pump.	8006
State supplementary source.	8022
State DHW.	8003
State swimming pool.	8011
State heating circuit 1.	8000
State heating circuit 2.	8001
State cooling circuit 1.	8004
Outdoor temperature.	8700
Room temperature 1.	8740
Room setpoint 1.	
Flow temperature 1.	8743
Flow temperature setpoint1.	
Room temperature 2.	8770
Room setpoint 2.	
Flow temperature 2.	8773
Flow temperature setpoint 2.	
DHW (domestic hot water) temperature.	8830
Heat pump return temperature.	8410
Setpoint (return) HP.	
Heat pump flow temperature.	8412
Setpoint (flow) HP.	
Swimming pool temperature.	8900
Swimming pool temperature setpoint.	
Minimum remaining stop time for compressor 1.	-
Minimum remaining running time for compressor 1.	-

### 3.9 Details

If the electrical power supply has been cut off while the heat pump is operating (electrical power failure or unprogrammed pressing of the on/off switch on the hydraulic unit) the display will show error 370 when the appliance restarts. Do not be concerned, the communication between the outdoor and hydraulic unit will re-establish itself in a few moments.

### 3.10 Operation of the DHW system

The key enables you to switch the DHW (domestic hot water) mode on and off. The selection is shown by a bar, which appears under the corresponding symbol.

Manual activation: Hold down the DHW key for 3 seconds (Switch from "reduced" to "nominal" until the next time the DHW timer switches over).

To ensure a DHW setting over 45°C, the electrical back-up heating or the boiler must be left on.

In order to optimise operation of the DHW, it is possible to:

- Program the timer settings (parameters 560 to 576),
- Adjust the comfort temperature set point (parameter 1610),
- Adjust the reduced temperature set point (parameter 1612).

Press the info key to obtain the details on the DHW (temperature setting operation).

### 3.11 Selecting cooling mode

If the installation is fitted with the cooling kit.

The key activates and deactivates cooling mode.

### 3.12 Pilot wire (if kit regulation extension AVS 55)

It's possible to order up to 15 electric heaters via output "pilot wire".

The "pilot wire" handles only the hourly operation of electric heaters (comfort mode / reduced mode commutation and Frost protection mode).

The comfort temperature setting should be done directly on the electric heater(s). The "pilot wire" does not handle the temperature of the electric heaters. Refer to the manual supplied with the electric heater(s).

Put the electric heaters on "PROG" mode or "AUTO" mode for piloting by the regulation board.

The difference between the comfort temperature and the reduced temperature is from 3,5 ° C.

Frost protection temperature is set directly on the electric heaters. Refer to the manual supplied with the electric heater(s).

In the absence of signal, electric heaters operating in comfort mode.

### 3.13 Telephone modem (if Regulation extension kit AVS 55)

It is possible to command the switching of the heating mode to the "freeze" protection mode / reduced (and vice versa) on the heat pump using a modem contact.

The telephone command switches the current heat pump settings to "freeze" protection mode / reduced (and vice versa). In accordance with the setting, any temperature requests from the heating circuits and the DHW are ignored or activated.

The "freeze" protection mode / reduced must not be selected on the heat pump and/or the remote control.

See with your installer.

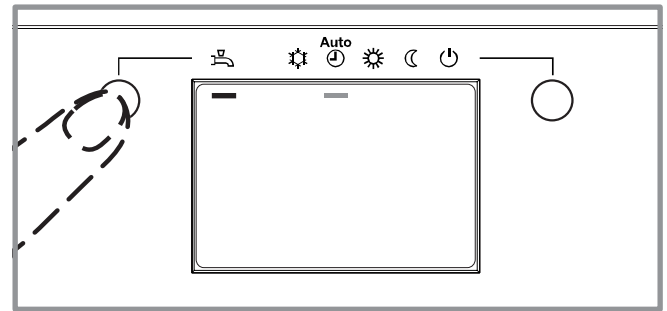


figure 10 - Select the DHW mode

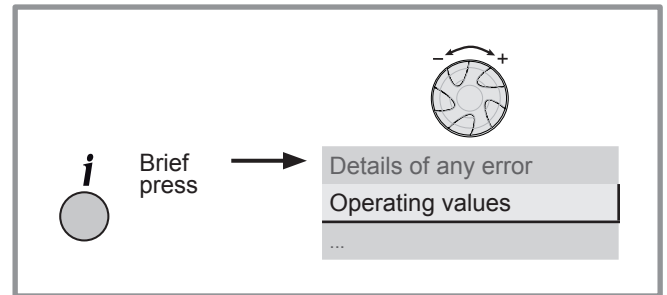


figure 11 - Information key

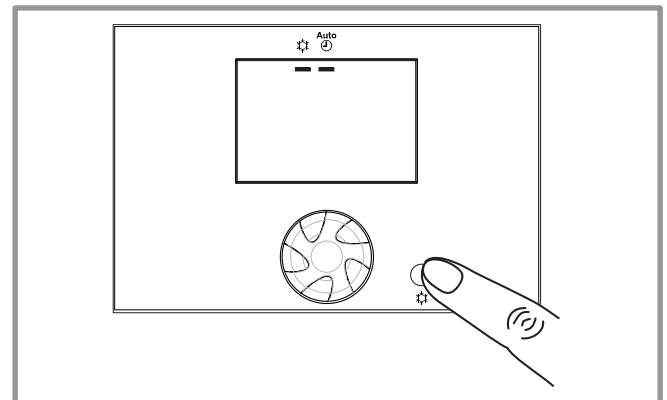


figure 12 - Selecting cooling mode

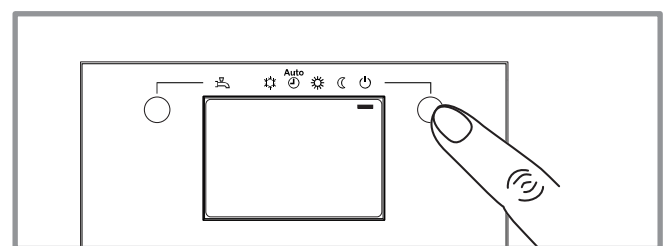


figure 13 - Selecting the frost protection

### 3.14 Configuring room control unit (option)

In the event that the room control unit (see figure 2), is used, on start-up, after initialising for around 3 minutes, the language needs setting:

- Press OK.
- Choose menu "Operator section".
- Choose language "Language" **English**.

## 4 Maintenance

In order to insure your appliance operates correctly for many years, the maintenance operations described below are required at the start of each heating season. Generally, these are performed as part of a service contract.

### 4.1 Regular checks

- Periodically check the water pressure in the heating circuit (Refer to the pressure recommended by the installer - between 1 to 2 bar).
- If filling and re-pressurization are required, check what type of fluid has been used initially (If in any doubt, contact your installer).

- If frequent refills are required it is essential that you look for any leaks.

☞ **The frequent water supply is at risk of scaling for the Heat exchanger and degrades performance and longevity of it.**

### 4.2 Checking the outdoor unit

Dust off the heat exchanger if necessary, being careful not to damage the fins.

Check that there is nothing obstructing the passage of air.

#### • Checking the refrigeration circuit

When the refrigerant charge is in excess of 2kg (models > 8 kW) it is compulsory to have an approved after sales service check the refrigeration circuit every year (with a certificate of capacity for the handling of refrigerants). Consult your heating technician.

### 4.3 Domestic hot water tank

Maintenance of the tank must be undertaken once a year (The frequency may vary according to water hardness).

Consult your heating technician.

#### • ACI Operation

- In normal operation, the light flashes (ref. 2).

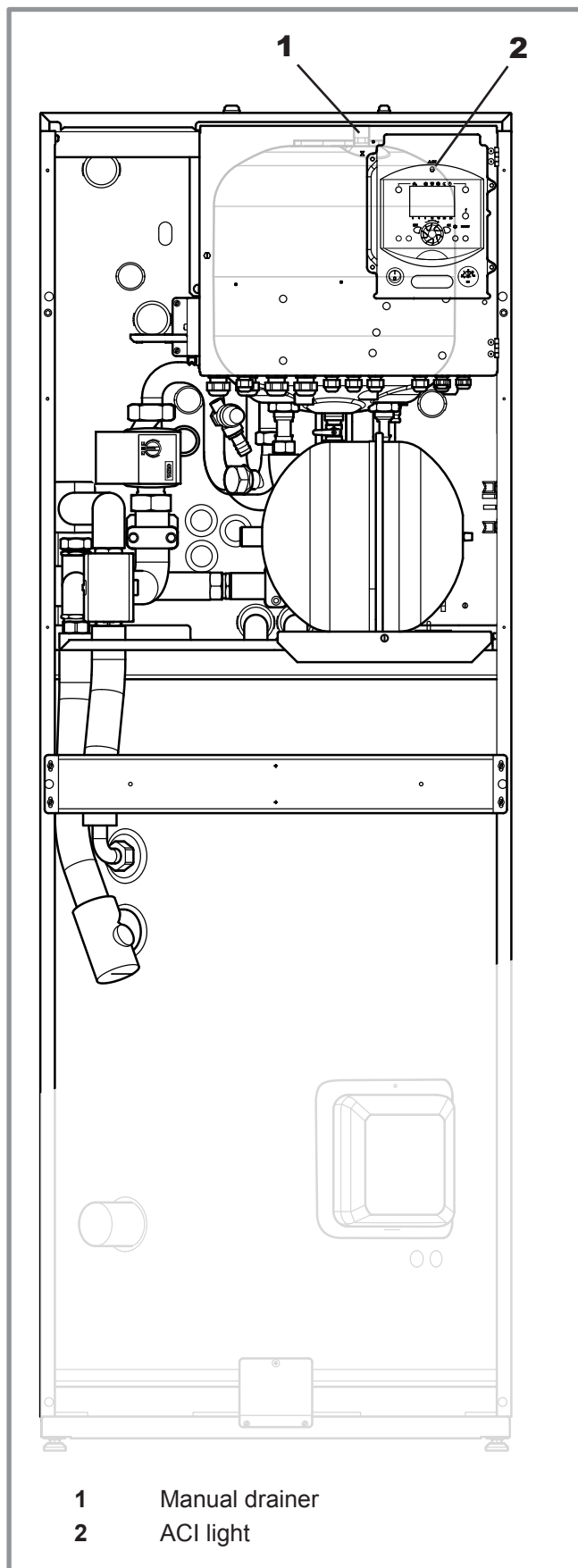






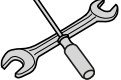


figure 14 - Manual drainer & ACI light

	<b>OFF</b>	LED Off: The pump does not work, no electrical power.
		Green LED on: The pump works normally.
	<b>10 min.</b>	Green LED blink: Venting operating mode (10 minutes).
	<b>Auto Test</b>	Green/Red LED blink: Operating error with automatic reboot.
		Red LED blink: Operating error.

*figure 15 - Operation signals the HP circulator*

## ErP performance values

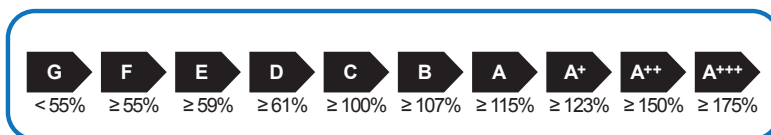
### • ErP Definition

"ErP" includes two directives that are part of the program for the reduction of green house gas emission :

- Eco-design directive sets efficiency thresholds and prohibits the sale of any product with efficiency lower than the set thresholds.
- According to labelling directive, energetic efficiency shall be displayed to encourage end-users to purchase energy-efficient products.

### • Package fiche (Comfort models)

☞ application 35 °C

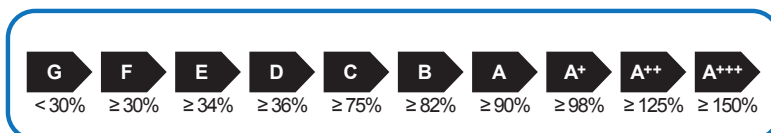


Models	Waterstage ...	Comfort Integrated DHW 5		Comfort Integrated DHW 6		Comfort Integrated DHW 8		Comfort Integrated DHW 10	
<b>Hydraulic unit reference</b>		<b>WG YA050DG6</b>		<b>WG YA100DG6</b>		<b>WG YA100DG6</b>		<b>WG YA100DG6</b>	
Seasonal space heating energy efficiency of heat pump		169%		169%		157%		155%	
Type of temperature control (* = Outdoor sensor ; ** = Room unit)		* class II	** class VI	* class II	** class VI	* class II	** class VI	* class II	** class VI
Bonus		2%	4%	2%	4%	2%	4%	2%	4%
Seasonal space heating energy efficiency of package <b>under average climate</b>		171%	173%	171%	173%	159%	161%	157%	159%
Energy class of package		A++	A++	A++	A++	A++	A++	A++	A++
Seasonal space heating energy efficiency of package <b>under warmer climate</b>		219%	221%	214%	215%	209%	211%	198%	200%
Seasonal space heating energy efficiency of package <b>under colder climate</b>		NA							

The energy efficiency of the package of products provided for in this fiche may not correspond to its actual energy efficiency once installed in a building, as the efficiency is influenced by further factors such as heat loss in the distribution system and the dimensioning of the products in relation to building size and characteristics.

Electrical back up heater consumption is taken into account in the performance calculation.

☞ application 55 °C



Models	Waterstage ...	Comfort Integrated DHW 5		Comfort Integrated DHW 6		Comfort Integrated DHW 8		Comfort Integrated DHW 10	
<b>Hydraulic unit reference</b>		<b>WG YA050DG6</b>		<b>WG YA100DG6</b>		<b>WG YA100DG6</b>		<b>WG YA100DG6</b>	
Seasonal space heating energy efficiency of heat pump		115%		115%		118%		113%	
Type of temperature control (* = Outdoor sensor ; ** = Room unit)		* class II	** class VI	* class II	** class VI	* class II	** class VI	* class II	** class VI
Bonus		2%	4%	2%	4%	2%	4%	2%	4%
Seasonal space heating energy efficiency of package <b>under average climate</b>		117%	119%	117%	119%	120%	122%	115%	117%
Energy class of package		A+	A+	A+	A+	A+	A+	A+	A+
Seasonal space heating energy efficiency of package <b>under warmer climate</b>		141%	143%	140%	142%	140%	142%	138%	140%
Seasonal space heating energy efficiency of package <b>under colder climate</b>		NA							

The energy efficiency of the package of products provided for in this fiche may not correspond to its actual energy efficiency once installed in a building, as the efficiency is influenced by further factors such as heat loss in the distribution system and the dimensioning of the products in relation to building size and characteristics.

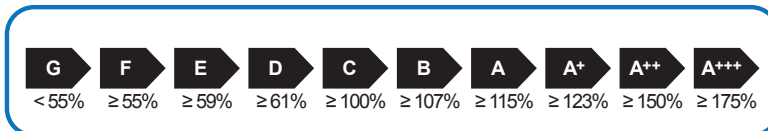
Electrical back up heater consumption is taken into account in the performance calculation.

Outdoor sensor included in the package	
Controller class	II
Contribution to energy efficiency	2%

Room unit references	UTW-C55XA UTW-C58XD UTW-C74XF UTW-C74HXF UTW-C78XD
Controller class	VI
Contribution to energy efficiency	4%

• Package fiche (HP models)

☞ application 35 °C

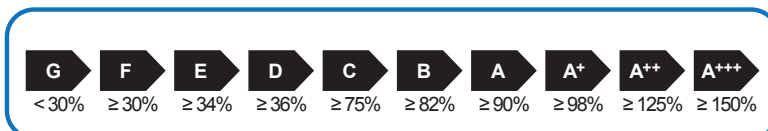


Models	Waterstage ...	HP 11 Single phase type		HP 14 Single phase type		HP 11 3-Phase		HP 14 3-Phase		HP 16 3-Phase	
<b>Hydraulic unit reference</b>		<b>WGYG140DG6</b>		<b>WGYG140DG6</b>		<b>WGYK160DG9</b>		<b>WGYK160DG9</b>		<b>WGYK160DG9</b>	
Seasonal space heating energy efficiency of heat pump		151%		148%		154%		150%		149%	
Type of temperature control (* = Outdoor sensor ; ** = Room unit)		*classe II	**classe VI	*classe II	**classe VI	*classe II	**classe VI	*classe II	**classe VI	*classe II	**classe VI
Bonus		2%	4%	2%	4%	2%	4%	2%	4%	2%	4%
Seasonal space heating energy efficiency of package <b>under average climate</b>		153%	155%	150%	152%	156%	158%	152%	154%	151%	153%
Energy class of package		A++	A++	A++	A++	A++	A++	A++	A++	A++	A++
Seasonal space heating energy efficiency of package <b>under warmer climate</b>		173%	175%	178%	180%	207%	209%	198%	200%	190%	192%
Seasonal space heating energy efficiency of package <b>under colder climate</b>		123%	125%	120%	122%	126%	128%	124%	126%	121%	123%

The energy efficiency of the package of products provided for in this fiche may not correspond to its actual energy efficiency once installed in a building, as the efficiency is influenced by further factors such as heat loss in the distribution system and the dimensioning of the products in relation to building size and characteristics.

Electrical back up heater consumption is taken into account in the performance calculation.

☞ application 55 °C



Models	Waterstage ...	HP 11 Single phase type		HP 14 Single phase type		HP 11 3-Phase		HP 14 3-Phase		HP 16 3-Phase	
<b>Hydraulic unit reference</b>		<b>WGYG140DG6</b>		<b>WGYG140DG6</b>		<b>WGYK160DG9</b>		<b>WGYK160DG9</b>		<b>WGYK160DG9</b>	
Seasonal space heating energy efficiency of heat pump		112%		113%		112%		117%		117%	
Type of temperature control (* = Outdoor sensor ; ** = Room unit)		*classe II	**classe VI	*classe II	**classe VI	*classe II	**classe VI	*classe II	**classe VI	*classe II	**classe VI
Bonus		2%	4%	2%	4%	2%	4%	2%	4%	2%	4%
Seasonal space heating energy efficiency of package <b>under average climate</b>		114%	116%	115%	117%	114%	116%	119%	121%	119%	121%
Energy class of package		A+	A+	A+	A+	A+	A+	A+	A+	A+	A+
Seasonal space heating energy efficiency of package <b>under warmer climate</b>		122%	124%	121%	123%	138%	140%	139%	141%	143%	145%
Seasonal space heating energy efficiency of package <b>under colder climate</b>		102%	104%	102%	104%	102%	104%	102%	104%	102%	104%

The energy efficiency of the package of products provided for in this fiche may not correspond to its actual energy efficiency once installed in a building, as the efficiency is influenced by further factors such as heat loss in the distribution system and the dimensioning of the products in relation to building size and characteristics.

Electrical back up heater consumption is taken into account in the performance calculation.



Outdoor sensor included in the package	
Controller class	II
Contribution to energy efficiency	2%

Room unit references	UTW-C55XA UTW-C58XD UTW-C74TXF UTW-C74HXF UTW-C78XD
Controller class	VI
Contribution to energy efficiency	4%















This appliance is marked with this symbol. This means that electrical and electronic products shall not be mixed with general household waste. European Community countries(\*), Norway, Iceland and Liechtenstein should have a dedicated collection system for these products. Do not try to dismantle the system yourself as this could have harmful effects on your health and on the environment. The dismantling and treatment of refrigerant, oil and other parts must be done by a qualified installer in accordance with relevant local and national regulations. This appliance must be treated at a specialized treatment facility for re-use, recycling and other forms of recovery and shall not be disposed of in the municipal waste stream. Please contact the installer or local authority for more information.  
\* subject to the national law of each member state

---

*Date of installation :*

*Contact of your heating technician or your after-sales service.*