

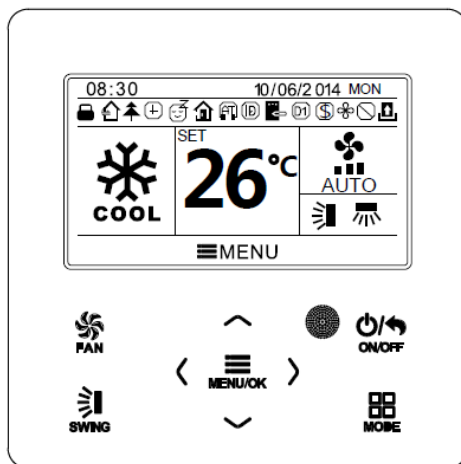

IM

En



Serie

WIRED CONTROL LIBERTY

Edition

R00

Models

ACCD_WC3

User Notices

For correct installation and operation, please read all instructions carefully. Before reading the instructions, please be aware of the following items:

(1) Prohibit installing the wired controller at wet or sunshine places.

(2) Do not knock, throw or frequently disassemble the wired controller.

(3) Do not operate the wired controller with wet hands.

(4) Do not remove or install the wired controller by yourself. If there is any question, please contact our after-sales service center.

(5) The wired controller is a general model, applicable for several kinds of units. Some functions of the wired controller are not available for certain kinds of units, more details please refer to the owner's manual of unit. The setting of such unavailable function will not affect unit's operation.

(6) The wired controller is universal. The remote receiver is either in the indoor unit or in the wired controller. Please refer to the specific models.

Contents

1 Display	1
1.1 Appearance.....	1
1.2 Instructions for Related Displayed Symbols	2
2 Buttons	3
2.1 Button Graphics	3
2.2 Function Instructions of Buttons	3
3 Operation Instructions.....	3
3.1 Menu Structure.....	3
3.2 On/Off	5
3.3 Mode Setting.....	5
3.4 Temperature Setting.....	5
3.5 Fan Setting	5
3.6 Swing Setting	6
3.7 Functions Setting	8
3.8 Unit Status View	12
3.9 Current Error View	13
3.10 Timer Setting.....	15
3.11 Clock Setting	20
3.12 Lock Setting	21
4 Installation Instructions	22
4.1 Parts and Dimension of Wired Controller	22
4.2 Installation Requirements.....	23
4.3 Installation Methods	23
4.4 Disassembly	26

1 Display

1.1 Appearance

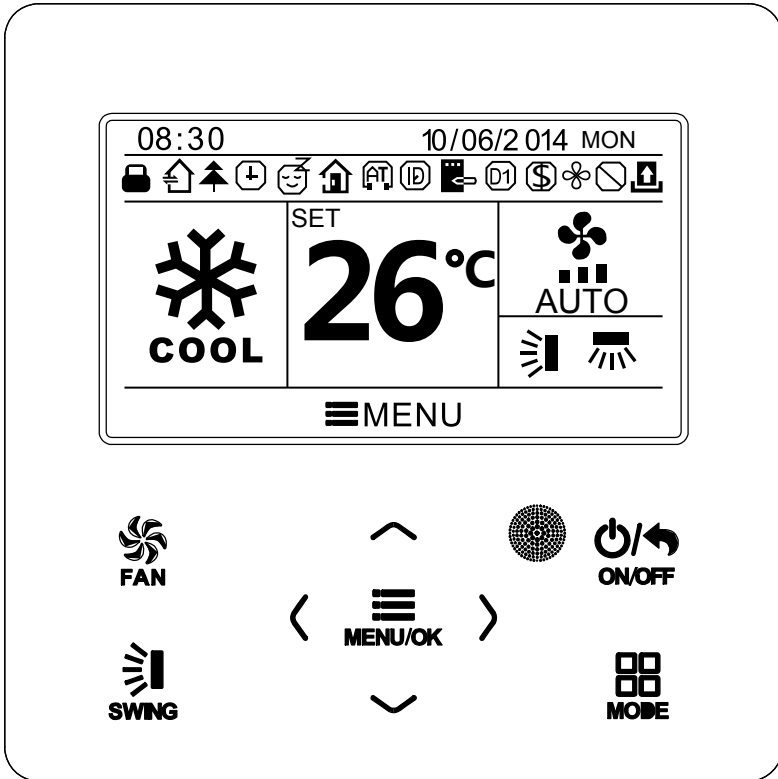























Fig.1 Appearance of wired controller

1.2 Instructions for Related Displayed Symbols

No.	Symbols	Instructions
1		Up and down swing function
2		Left and right swing function
3		Fresh air function
4		Sleep function
5		Auto mode
6		Cooling mode
7		Dry mode
8		Fan mode
9		Heating mode
10		Health function
11		I-Demand function
12		Absence function
13		Shielding status (Buttons, temperature, ON/OFF, mode or energy saving is shielded by remote monitor)
14		Current set fan speed
15		Memory function (Memory in power failure)
16		DRED function
17		Save function
18		X-fan function
19		Timer on status
20		Gate card pulled-off status or nobody presented status
21		Quiet function
22		Function lock

2 Buttons

2.1 Button Graphics

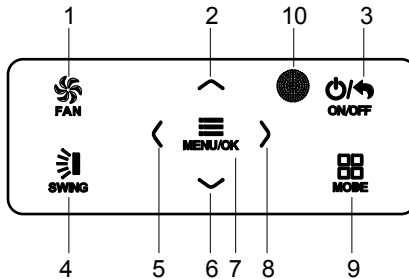

Fig. 2 Button graphics

2.2 Function Instructions of Buttons

No.	Button name	Button Function
1	FAN	Set low speed, medium speed, high speed, turbo and auto speed.
2	^	(1) Set temperature
6	v	(2) Set parameter (3) Move option cursor
3	ON/OFF/BACK	(1) Turn on or turn off unit (2) Return to last page
4	SWING	Set up&down swing and set left&right swing
5	<	(1) Set related function on or off
8	>	(2) Move option cursor (3) Set parameter
7	MENU/OK	(1) Enter menu page (2) Confirm setting
9	MODE	Set auto, cooling, dry, fan and heating modes for indoor unit.
10	Remote control receiver window	

3 Operation Instructions

3.1 Menu Structure

Normal setting of wired controller can be set directly on the main page, including fan speed, swing, set temperature, mode, ON/OFF. The setting and status view of other functions can be set in corresponding submenu. Detailed menu structure is as shown in Fig. 3.

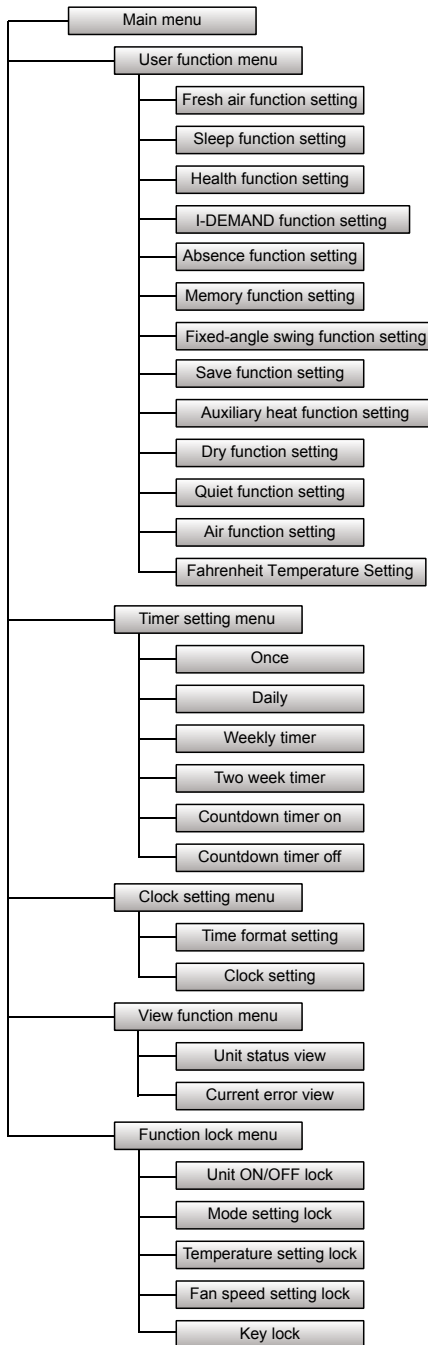

Fig. 3 Menu structure

3.2 On/Off

When the wired control is on main page, press ON/OFF button to turn on the unit. Press ON/OFF button again to turn off the unit. The interfaces of On/Off status are shown in Fig. 4 and Fig. 5.

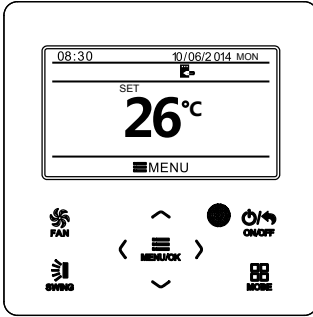

Fig. 4 Off interface

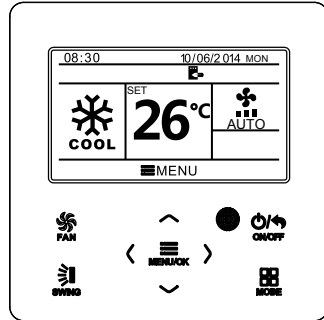
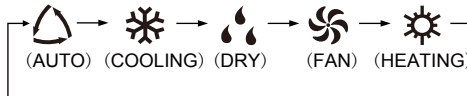

Fig. 5 On interface

3.3 Mode Setting

Under On status, pressing MODE button can set mode circularly as:



Note: If save function is on, auto mode is not available.

3.4 Temperature Setting

Under unit on status, pressing “^” or “v” button on the main page increases or decreases set temperature by 1°C(1°F); holding “^” or “v” button increases or decreases set temperature by 1°C(1°F) every 0.3s.

In cooling,dry,fan and heating mode,temperature setting range is 16°C~30°C (61°F~86°F). Under auto mode, set temperature cannot be adjusted.

3.5 Fan Setting

Under On status, pressing FAN button can set fan speed circularly as:

Low→Medium→High→Turbo→Auto→Low

Symbols displayed are as shown in Fig. 6.



Fig. 6 Fan setting

3.6 Swing Setting

In unit on status, press SWING button for swing setting. Two swing modes are available: fixed-angle swing and simple swing.

When fixed-angle swing mode is set, swing operation is as follows:

In unit on status, press SWING button to select up&down swing . Up&down swing angle will be adjusted circularly as below:

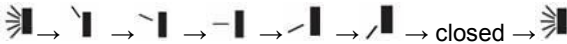



Select up&down swing and left&right swing through “<” or “>” button. When left&right swing  is selected. Left&right swing angle will be adjusted circularly as below:



Note:

- ①. Turn on fixed-angle swing mode in function setting page;
- ②. If fixed-angle swing is not available for the model, fixed-angle swing will be invalid when the wired controller turns on fixed-angle swing mode.

Simple swing mode: when fixed-angle swing mode is turned off, swing operation is as below:

Pressing SWING button under unit on status, up&down swing frame occurs. Then press SWING button to turn on or turn off up&down swing.  is displayed when up&down swing is on and is not displayed when up&down swing is off. When up&down swing frame have not disappeared, press “<” or “>” button to switch to left&right swing setting. Then left&right swing frame occurs. In this case, press SWING button to turn on or turn off left&right swing.  is displayed when left&right swing is on and is not displayed when left&right swing is off. For detailed operation, please refer to Fig. 7.

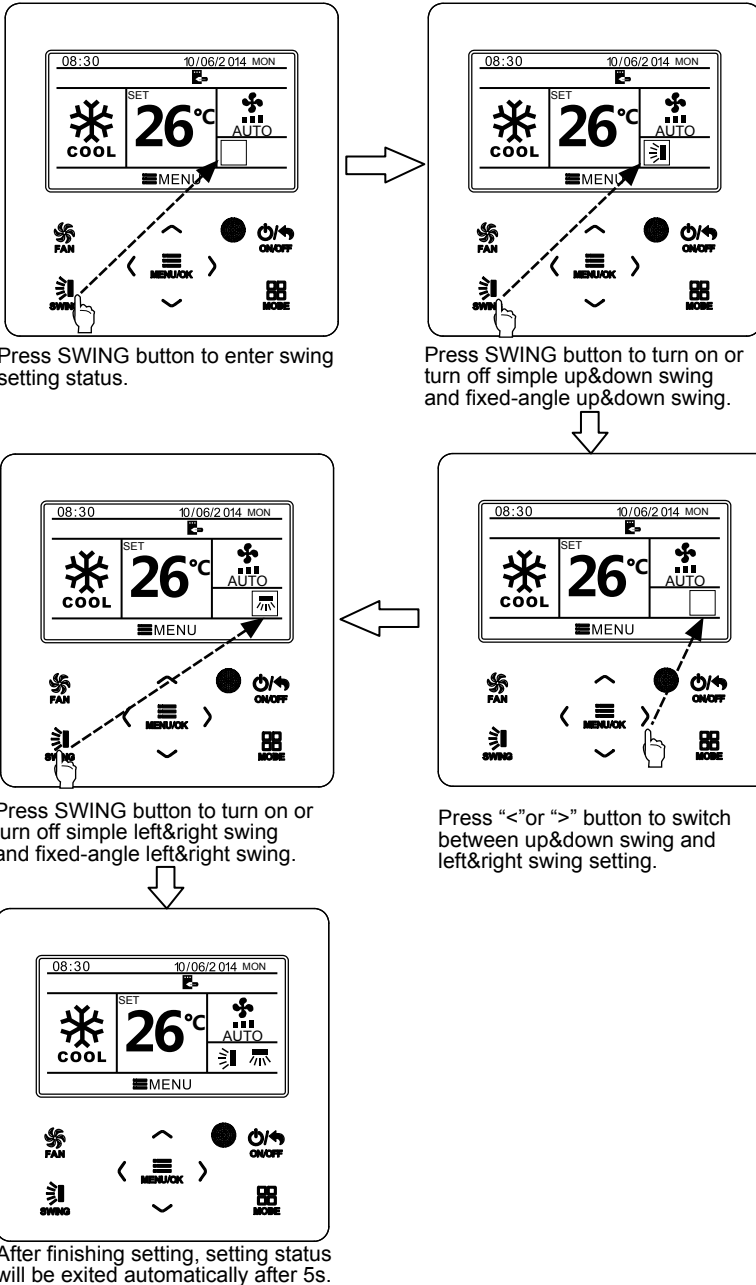

Fig. 7 Swing setting

3.7 Functions Setting

Press MENU/OK button on main page to enter main menu page. Press “^” or “v” or “<” or “>” button to select the function setting symbol. Then press MENU/OK button to enter user function setting page. Press “^” or “v” button to select specific function item. Press “<” or “>” button to turn on or turn off this function. If the function item can't be set, it will displays with gray color. Please refer to Fig.8.

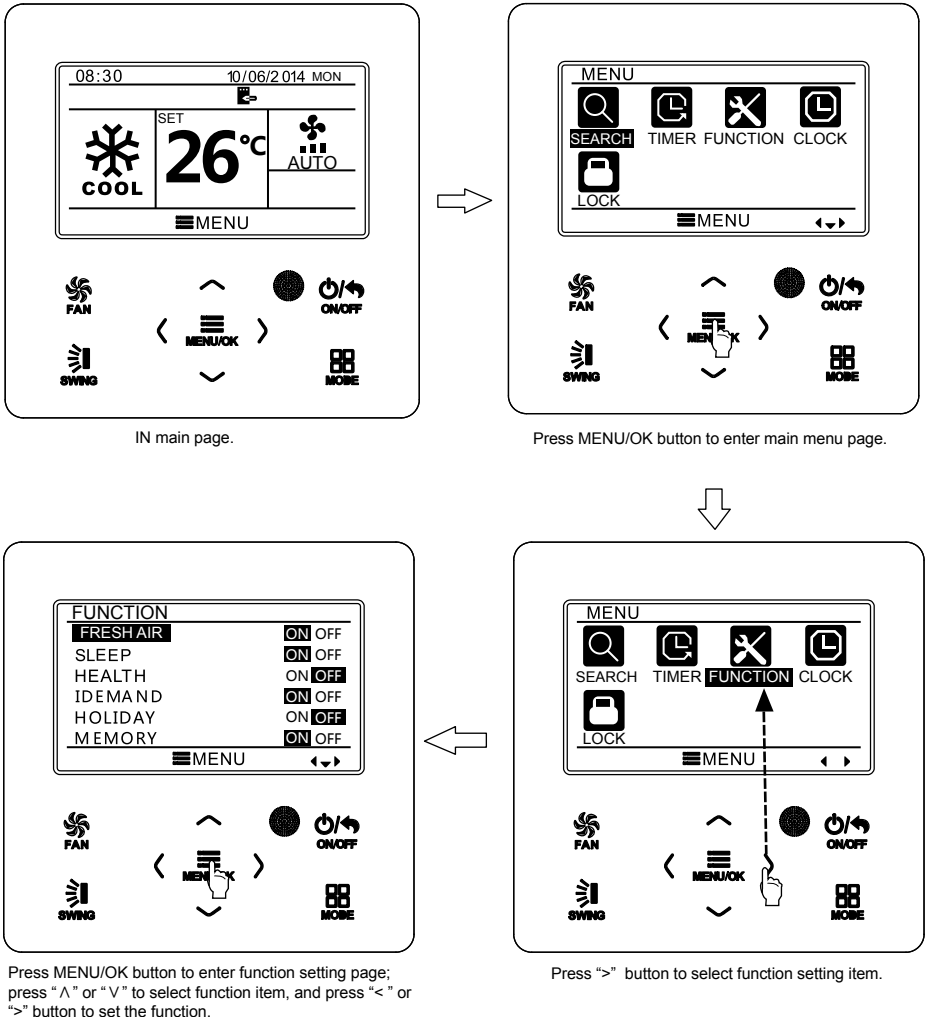

Fig. 8 Function setting

3.7.1 Fresh Air Function Setting

After entering user function page, press “^” or “v” button to select fresh air function and press “<” or “>” button to turn on or turn off air function. Press MENU button to adjust the mode of fresh air.

After entering fresh air mode setting, press “^” or “v” button to adjust the mode in the range of 1~10. After setting, press MENU button to save the setting.

3.7.2 Sleep Function Setting

After entering user function page, press “^” or “v” button to select sleep function and press “<” or “>” button to turn on or turn off sleep function with auto saving.

If this function is turned on, the unit will operate according to the preset sleep curve to provide comfortable sleep environment.

Note:

- In fan or auto mode, sleep function is not available.
- Sleep function will be cancelled when turning off the unit or switching modes.

3.7.3 Health Function Setting

After entering user function page, press “^” or “v” button to select health function and press “<” or “>” button to turn on or turn off health function with auto saving.

3.7.4 I-DEMAND Function Setting

After entering user function page, press “^” or “v” button to select IDEMAND function option and press “<” or “>” button to turn on or turn off this function with auto saving.

Note:

- This function is only available in cooling mode.
- When this function has been set, set temperature is displayed in SE. In this case, temperature setting and fan speed setting are shielded.
- This function will be cancelled when switching modes.
- This function and sleep function cannot be on simultaneously. If I-demand function is set firstly and then sleep function is set, I-demand function will be cancelled while sleep function will be valid, and vice versa.

3.7.5 Absence Function Setting

After entering user function page, press “^” or “v” button to select holiday function option and press “<” or “>” button to turn on or turn off this function with auto saving.

This function is used to maintain indoor temperature so that unit can realize fast heating.

Note:

- This function is only available in heating mode.
- When this function has been set, set temperature is displayed in 8C (46°F). In this case, temperature setting and fan speed setting are shielded.
- This function will be cancelled when switching modes.
- This function and sleep function cannot be on simultaneously. If absence function is set firstly and then sleep function is set, absence function will be cancelled while sleep function will be valid, and vice versa.

3.7.6 Memory Function Setting

After entering user function page, press “^” or “v” button to select memory function and press “<” or “>” button to turn on or turn off memory function with auto saving.

3.7.7 Fixed-angle Swing Mode Setting

After entering user function page, press “^” or “v” button to select lock swing function option and press “<” or “>” button to turn on or turn off this function with auto saving.

Note: If fixed-angle swing function is not available for the connected unit, this function will be cancelled automatically after setting.

3.7.8 Save Function Setting

After entering user function page, press “^” or “v” button to select save function and press “<” or “>” button to turn on or turn off save function. Press MENU button to enter save function setting page.

After entering save function setting page, press “<” or “>” button to select cooling or heating limitation temperature. After selecting cooling or heating limitation temperature, press “^” or “v” button to adjust limitation temperature value. After setting, press MENU button to save the setting.

Note: When save function has been set, auto mode cannot be set.

3.7.9 Auxiliary Heating Function Setting

After entering user function page, press “^” or “v” button to select auxiliary heating function and press “<” or “>” button to turn on or turn off this function with auto saving.

3.7.10 X-fan Function Setting

After entering user function page, press “^” or “v” button to select dry function option and press “<” or “>” button to turn on or turn off this function with auto saving.

Note:

- This function is only available in cooling mode and dry mode.

3.7.11 Quiet Function Setting

After entering user function page, press “^” or “v” button to select quiet function and press “<” or “>” button to turn on or turn off this function with auto saving.

Note: This function is only available in cooling mode, heating mode and auto mode.

3.7.12 Fahrenheit Temperature Setting

After entering user function page, press “^” or “v” button to select Fahrenheit temperature function and press “<” or “>” button to turn on or turn off this function with auto saving. After closing this function, Celsius temperature will be displayed.

3.7.13 Air Function Setting

After entering user function page, press “^” or “v” button to select Air Function and press “<” or “>” button to turn on or turn off air function. Press MENU button to adjust the mode of Air Function .

After entering Air Function mode setting, press “^” or “v” button to adjust the mode in the range of 1~2. After setting, press MENU button to save the setting.

The each mode means as follows:1- suction 2-discharge

3.8 Unit Status View

Press MENU button to enter the menu and select the function symbol to be viewed. Then press MENU button to enter view function page. Press “^” or “v” button to select status view function. Press MENU button to enter unit status view page. Press BACK button to return to the last page. Please refer to Fig. 9.

The following statuses can be viewed: if auxiliary heating is operating;indoor ambient temperature; outdoor ambient temperature.

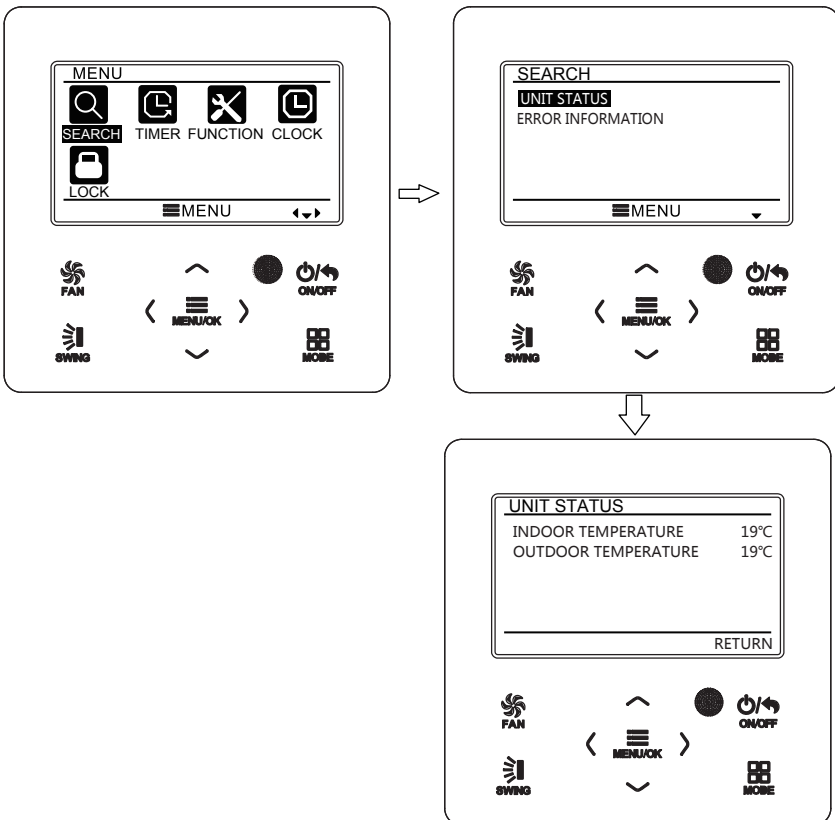

Fig. 9 Status View

3.9 Current Error View

When error occurs in the unit, error symbol will be displayed on the main page of wired controller to indicate that the unit is with error. In this case, you can enter error view page to view the current error.

Press MENU button to enter the menu and select the function symbol to be viewed. Then press MENU button to enter view function page. Press “^” or “v” button to select error information. Press MENU button to enter error view page. If there are too many errors, press “^” or “v” to turn pages. Press BACK button to return to the last page. Please refer to Fig. 10.

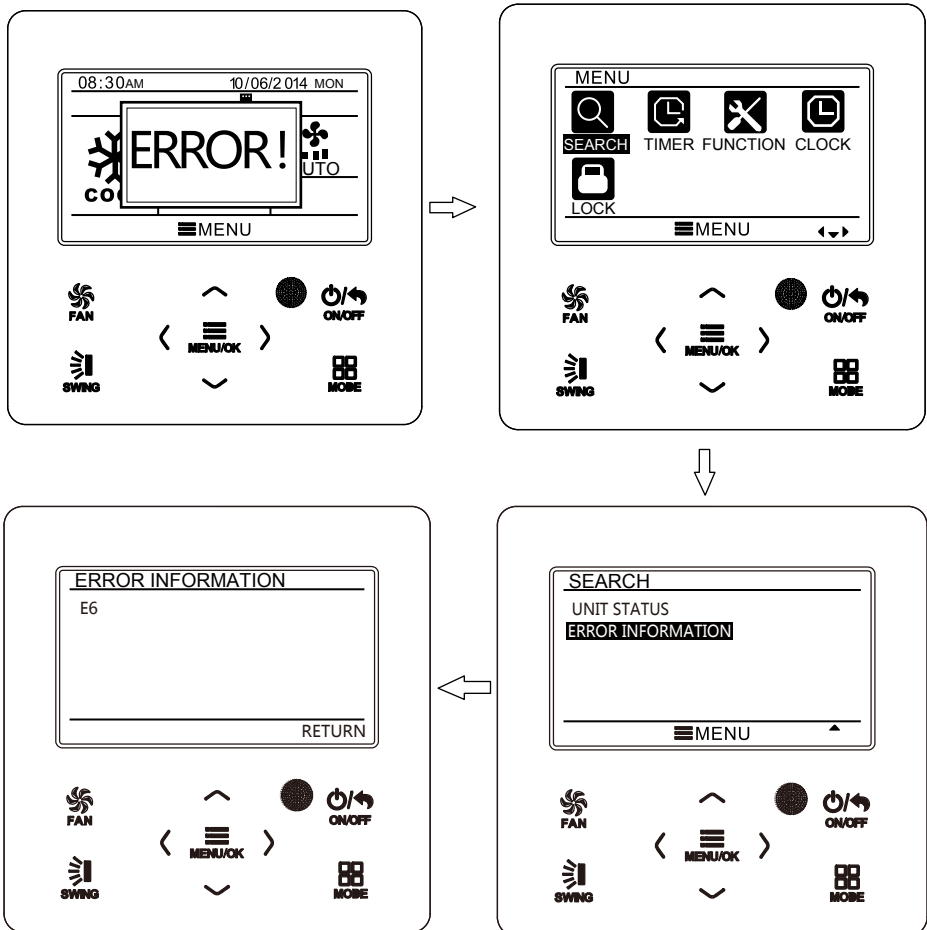

Fig. 10 Current Error View

Error	Error Code	Error	Error Code
Return air temperature sensor open/short circuited	F1	Drive board communication error	P6
evaporator temperature sensor open/short circuited	F2	Compressor overheating protection	H3
Indoor unit liquid valve temperature sensor open/short circuited	b5	Indoor and outdoor units unmatched	LP
Indoor gas valve temperature sensor open/ short circuited	b7	Communication line misconnected or expansion valve error	dn
IPM temperature sensor open/short circuited	P7	Running mode conflict	E7
Outdoor ambient temperature sensor open/ short circuited	F3	Pump-down	Fo
Outdoor unit condenser mid-tube temperature sensor open/short circuited	F4	Jumper error	C5
Discharge temperature sensor open/short circuited	F5	Forced defrosting	H1
Indoor and outdoor communication error	E6	Compressor startup failure	Lc
DC bus under-voltage protection	PL	High discharge temperature protection	E4
DC bus over-voltage protection	PH	Overload protection	E8
Compressor phase current sensing circuit error	U1	Whole unit over-current protection	E5
Compressor demagnetization protection	HE	Over phase current protection	P5
PFC protection	Hc	Compressor desynchronizing	H7
IPM Temperature Protection	P8	IPM Current protection	H5
Over-power protection	L9	Compressor phase loss/reversal protection	Ld
System charge shortage or blockage protection	F0	Frequency restricted/reduced with whole unit current protection	F8
Capacitor charging error	PU	Frequency restricted/reduced with IPM current protection	En
High pressure protection	E1	Frequency restricted/reduced with high discharge temperature	F9
Low pressure protection	E3	Frequency restricted/reduced with anti-freezing protection	FH
Compressor stalling	LE	Frequency restricted/reduced with overload protection	F6
Over-speeding	LF	Frequency restricted/reduced with IPM temperature protection	EU
Drive board temperature sensor error	PF	Indoor unit full water error	E9
AC contactor protection	P9	Anti-freezing protection	E2
Temperature drift protection	PE	AC input voltage abnormal	PP
Sensor connection protection	Pd	Whole unit current sensing circuit error	U5
DC bus voltage drop error	U3	4-way valve reversing error	U7
Outdoor fan 1 error protection	L3	Motor stalling	H6
Outdoor fan 2 error protection	LA	PG motor zero-crossing protection	U8
compressor inhalation temperature sensor error	dc	Indoor fan tripping error	U0

Error	Error Code	Error	Error Code
Communication error between IDU and grid connection	Ln	IDU network address error	y3
Communication error between ODU and grid connection	LM	Ip address allocation overflow	yb
Main error at grid connection side	y2		

3.10 Timer Setting

The wired controller can set 6 kinds of timer: one time clock timer, everyday timer, one week timer, two week timer, countdown timer on and countdown timer off. Select timer symbol after entering menu page. Press MENU button to enter timer setting page. Press “^” or “v” button to select one kind of timer. Press “<” or “>” button to turn on or turn off this timer. Please refer to Fig. 11.

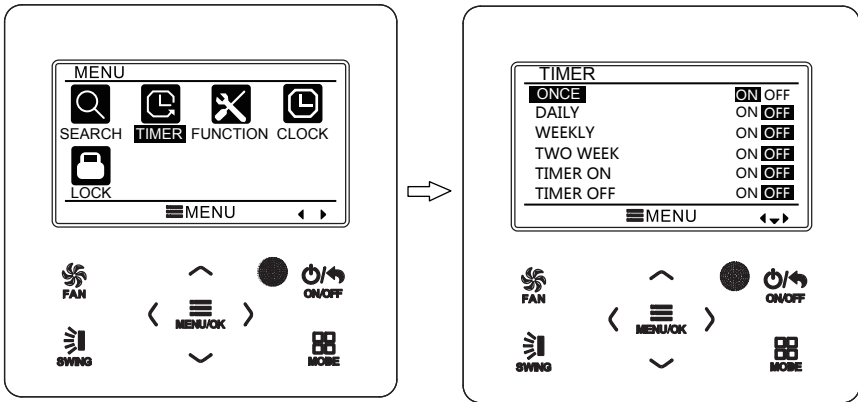

Fig. 11 Turn on or turn off timer

3.10.1 One Time Clock Timer

The wired controller can set one time clock timer. If the unit is off, timer on can be set. If the unit is on, timer off can be set. This timer will be carried out for only once when timer time is reached and then the timer will be off automatically.

In timer function setting page, when one time timer is selected, press “<” or “>” button to turn on or turn off this timer function. Press MENU button to enter timer time setting page, as shown in Fig. 12.

Press “<” or “>” button to select timer hour or minute and press “^” or “v” button to adjust time. Holding “^” or “v” button increases or decreases time rapidly. After finishing setting, press MENU button to save timer time.

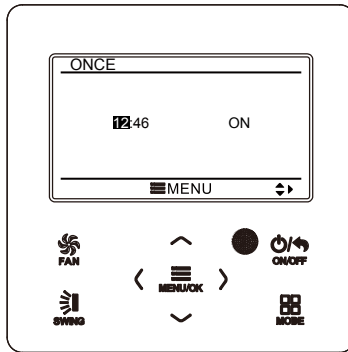

Fig. 12 Setting page of one time clock timer

Note: If this timer function is turned on, when the unit is turned on or turned off, this timer function will be cancelled automatically.

3.10.2 Daily Timer

In daily timer, user can set eight segments of timer individually. The individual segment will be valid only when it is turned on. In each segment, you can set time, unit ON/OFF, set temperature in cooling (it is valid only when the current mode is cooling), set temperature in heating (it is valid only when the current mode is heating). Please refer to Fig. 13.

After entering daily timer setting page, press “<” or “>” button item. Press “^” or “v” button to adjust the value. Press MENU button to save setting.

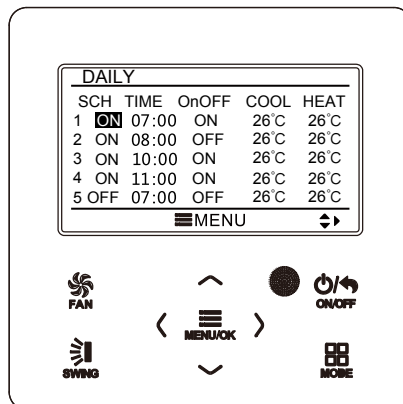

Fig. 13 Daily timer setting

3.10.3 Weekly Timer

The user can set the everyday timer content for a week. In each day, the user can set eight segments of timer content. The unit will execute corresponding timer setting in a week.

After entering weekly timer setting page, press “<” or “>” button to select the day to be set. Then press MENU button to enter timer programming of that day. Press “<” or “>” button to select the item to be set. Press “^” or “v” button to adjust the content. Press MENU button to save setting. Please refer to Fig. 14.

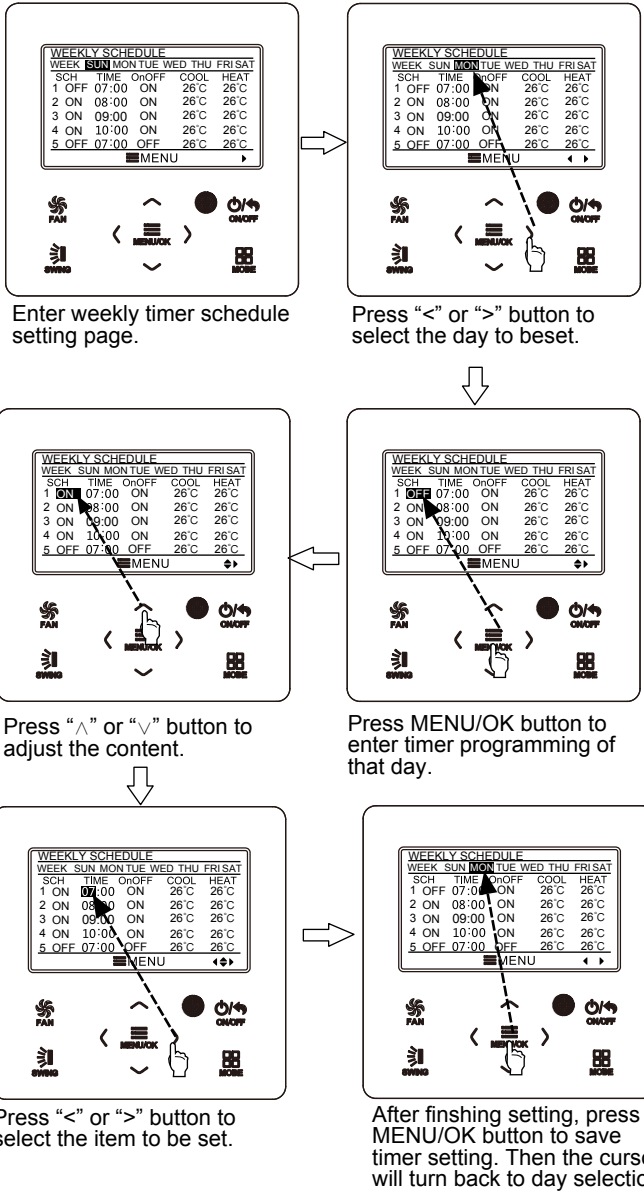

Fig. 14 Weekly timer setting

3.10.4 Two Week Timer

The user can set the everyday timer content for two weeks. In each day, the user can set eight segments of timer content. The unit will execute corresponding timer setting in two weeks.

In timer function setting page, press “^” or “v” button to select two week timer setting and then press MENU button to enter two week timer menu page. Press “^” or “v” button to select current week option and then press “<” or “>” button to set current week as first week or second week. Press MENU button to save current week setting. Please refer to Fig. 15.

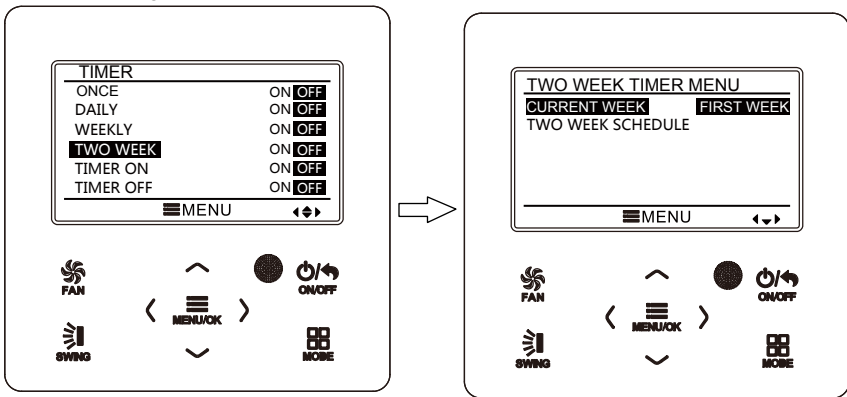

Fig. 15 Setting of current week

After entering two week timer menu page, press “^” or “v” button to select the two week schedule option and then press MENU button to enter two week timer programming. After entering two week timer setting page, press “<” or “>” button to select the day to be set. Then press MENU button to enter timer programming of that day. Press “<” or “>” button to select the item to be set. Press “^” or “v” button to adjust the content. Press MENU button to save setting. Press BACK button to exit this page. The setting symbols please refer to weekly timer setting.

3.10.5 Countdown Timer

Countdown timer includes timer on and timer off. Unit On/Off after a desired hour can be set. In unit on status, timer off can be set, or timer off and timer on can be set simultaneously. In unit off status, timer on can be set, or timer off and timer on can be set simultaneously. If timer off in x hours and timer on in y hours are set simultaneously in unit on status, the unit will be off in x hours and then the unit will be on in y hours after timer off.

After entering timer on setting page, press “ \wedge ” or “ \vee ” button to increases or decreases timer time by 0.5h. Press MENU button to save setting. Press BACK button to return to the last page. Please refer to Fig. 16.

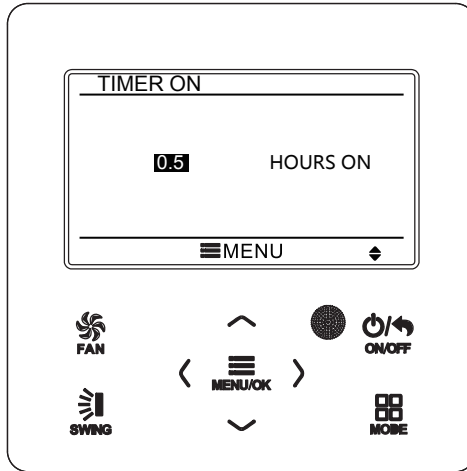

Fig. 16 Countdown timer on

After entering timer off setting page, press “ \wedge ” or “ \vee ” button to increases or decreases timer time by 0.5h. Press MENU button to save setting. Press BACK button to return to the last page. Please refer to Fig. 17.

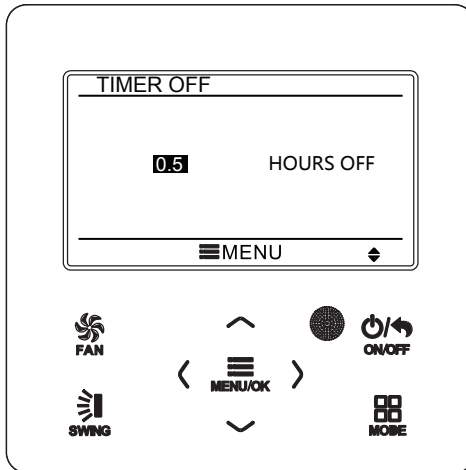

Fig. 17 Countdown timer off

If timer function is on, the set hours will decrease as the unit operation time increases. In this case, residual hours can be viewed after entering timer setting page.

This timer function will be carried out for only once and then it will be cancelled automatically.

Note: If this timer function is turned on, when the unit is turned on or turned off, this timer function will be cancelled automatically.

3.11 Clock Setting

3.11.1 Time Format Setting

The user can set the time format in 12-hour system or 24-hour system. Select clock symbol in menu page and then press MENU button to enter clock setting page. Press “^” or “v” button to select time format and then press “<” or “>” button to select 12-hour system or 24-hour system. Please refer to Fig. 18.

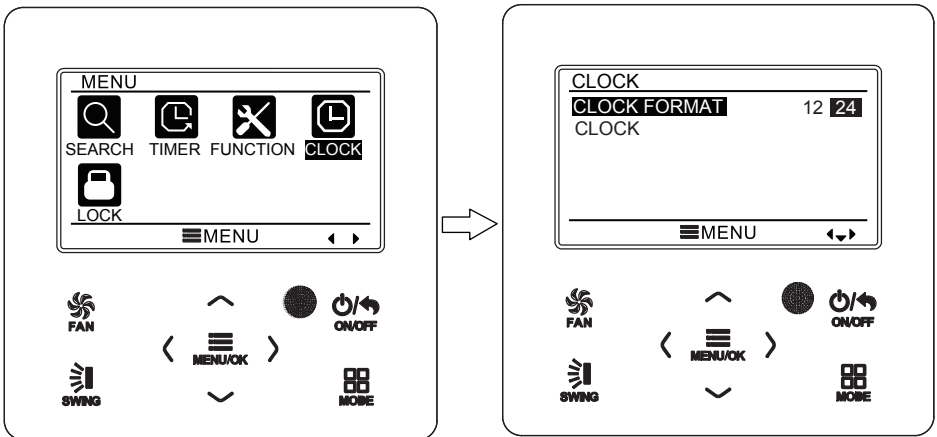

Fig. 18 Time format selection

3.11.2 Clock Setting

Select clock symbol in menu page and then press MENU button to enter clock setting page. Press “^” or “v” button to select time set and then press MENU button to enter time setting.

Press “<” or “>” button to select setting items: hour, minute, year, month, day; press “^” or “v” button to set the value and then press MENU button to save setting. Please refer to Fig. 19.

Note: If you need to use both the wired controller and remote controller, please set the time of them identically.

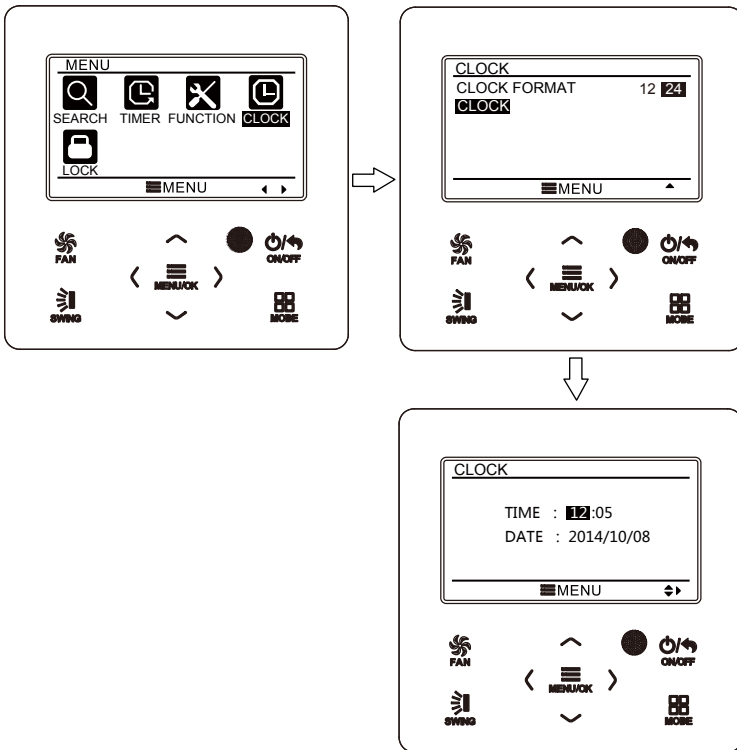

Fig. 19 Clock setting

3.12 Lock Setting

Select lock symbol in menu page and then press MENU button to enter lock setting page. Press “^” or “v” button to select the item to be locked and then press “<” or “>” button to lock or unlock. Please refer to Fig. 20.

Items can be locked: ON/OFF, mode setting, temperature setting, fan speed setting, key lock. After locking, the corresponding item cannot be set through buttons.

If the keys are locked, all keys cannot be operated after returning to the main page. Please unlock according to the instructions on main page. During unlocking, press MENU button, press “<” button and then press “>” button to unlock keys.

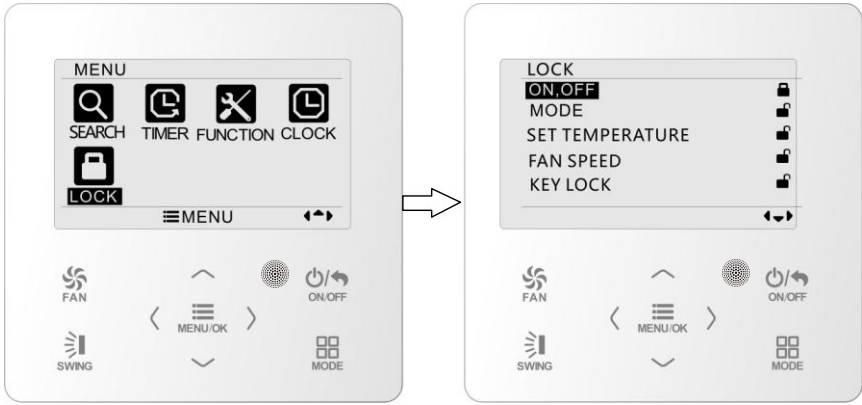

Fig. 20 Lock setting

4 Installation Instructions

4.1 Parts and Dimension of Wired Controller

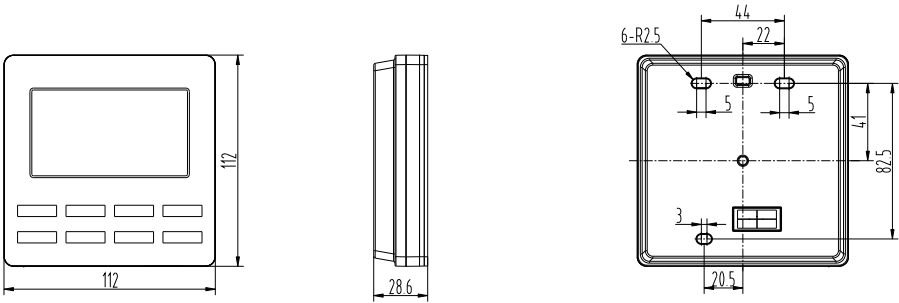

Fig. 21 Dimension of wired controller

unit: mm

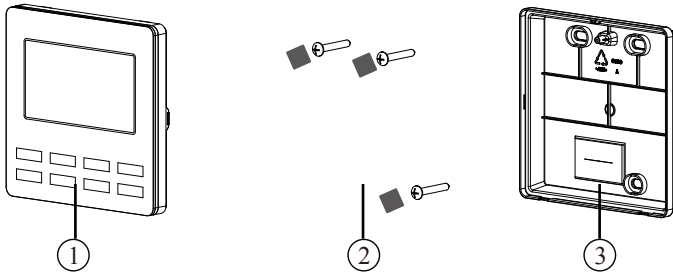

Fig. 22 Parts of wired controller

No.	1	2	3
Name	Panel of wired controller	Sponge 20×20×3 Screw M4×25	Soleplate of wired controller
Quantity	1	3	1

4.2 Installation Requirements

- (1) Prohibit installing the wired controller at wet places.
- (2) Prohibit installing the wired controller at the places with direct sunshine.
- (3) Prohibit installing the wired controller at the place near high temperature objects or water-splashing places.

4.3 Installation Methods

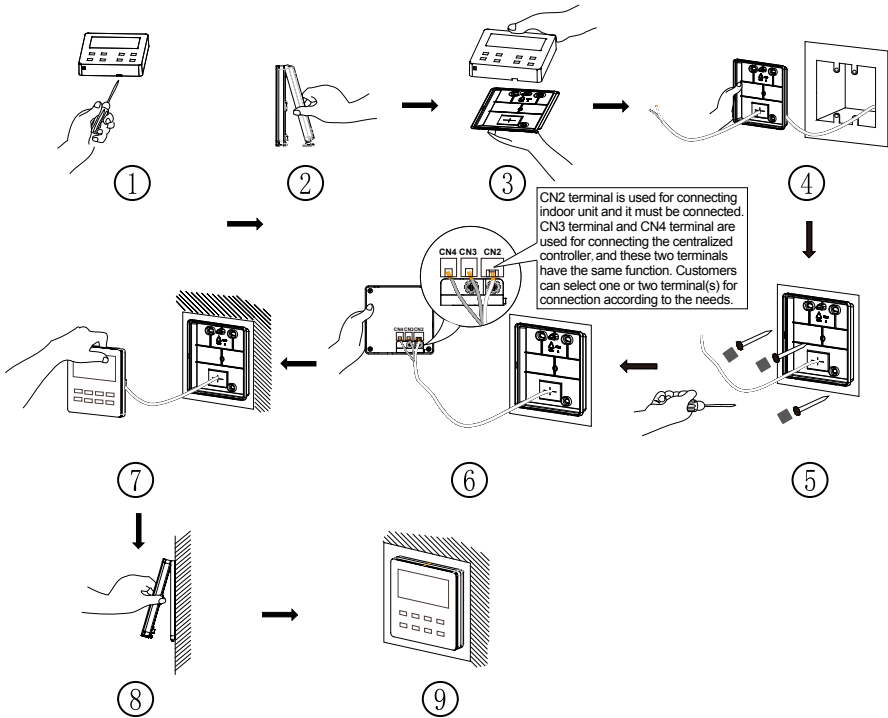

Fig. 23 Installation diagram for wired controller

Fig. 23 is the simple installation process of wired controller; please pay attention to the following items:

- (1) Before installation, please cut off the power for indoor unit;
- (2) Pull out the four-core twisted pair line from the installation holes and then let it go through the rectangular hole behind the soleplate of the wired controller.

- (3) Stick the soleplate of wired controller on the wall and then use screw M4×25 to fix soleplate and installation hole on wall together, attach the sponge 20×20×3 at the screw hole and then press it with fingers to make sure it's attached firmly.
- (4) Insert the four-core twisted pair line into the slot of the wired controller and then buckle the front panel and the soleplate of the wired controller together.
- (5) Block the four-core wire into the groove at the left side of wiring column; bundle the front panel of wired controller to its soleplate.

Note:

- Separate the signal and communication lines of the wired controller from the power cord and connection lines between the indoor and outdoor unit, with a minimum interval of 20cm, otherwise the communication of the unit will probably work abnormally.
- If the air conditioning unit is installed where is vulnerable to electromagnetic interference, then the signal and communication lines of the wired controller must be the shielding twisted pair lines.
- The 4-core terminal connects the air conditioner, while the 2-core terminal connects the centralized controller. The connecting method for the 2-core connection wire is same as that of 4-core connection wire.
- No need to set the wire of wired controller into the clasp.

For matching with different models, the patch cord and the connection wire are provided in the packaging box of wired controller. As shown in fig. A.

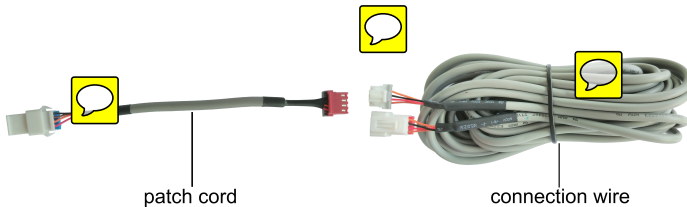

Fig. A: Schematic diagram of patch cord and connection wire

- If the air conditioner has been installed with the patch cord (fig. C) used for connecting the wired controller.

Only use the connection wire (fig. B) in the packing box of wired controller. Connect the terminal ② to the terminal ④ of patch cord which has been installed on the air conditioner; insert terminal ① to needle stand CN2 of wired controller. If there's protection terminal ③, pull out the protection terminal at first and then install it.

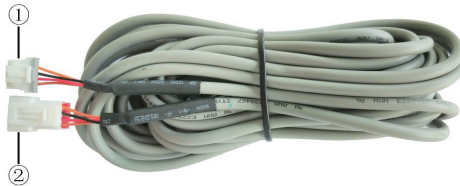

Fig. B: Schematic diagram of connection wire: Connect terminal ① with wired controller CN2; connect terminal ② with the terminal ④ of patch cord

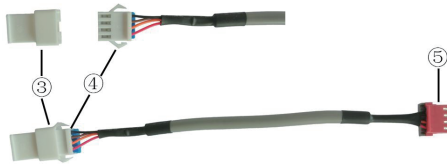

Fig. C: Schematic diagram of patch cord: Terminal ③ is the protection terminal; connect terminal ④ to the terminal ② of connection wire ; connect terminal ⑤ to the terminal of wired controller of air conditioner

- If the air conditioner hasn't been installed with the patch cord used for connecting the wired controller.

Use the connection wire and patch cord in the packing box of wired controller. Pull out the protection terminal of patch cord at first, connect the connection wire with the patch cord according to fig. D, and then insert the terminal ① of connection wire into the needle stand CN2 of wired controller and insert the terminal ⑤ of patch cord into the terminal of wired controller of air conditioner as well.

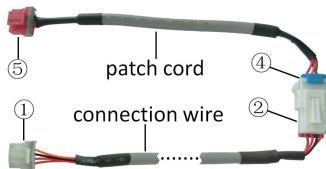

Fig. D: Schematic diagram after the connection wire and the patch cord have been connected: connect the terminal ② of connection wire and the terminal ④ of patch cord

4.4 Disassembly

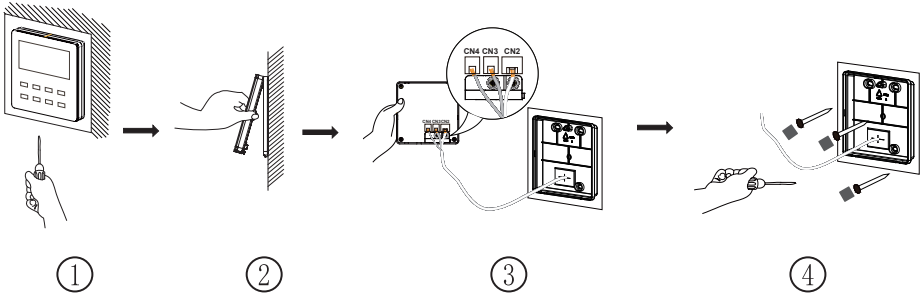

Fig. 24 Disassembly diagram for wired controller

dzitsu

EUROFRED
being efficient

Eurofred S.A.
Marqués de Sentmenat 97
08029 Barcelona
www.eurofred.es