

# daitsu

SERIE  
CDV-46

EDITION  
R00



## INSTALLATION AND MAINTENANCE MANUAL USER MANUAL

# WIRED CONTROLLER



Model: CDV-46



## To Users

Thank you for selecting Daitsu's product. Please read this instruction manual carefully before installing and using the product, so as to master and correctly use the product. In order to guide you to correctly install and use our product and achieve expected operating effect, we hereby instruct as below:

- (1) This appliance is not intended for use by persons (including children) with reduced physical, sensory or mental capabilities, or lack of experience and knowledge, unless they have been given supervision or instruction concerning use of the appliance by a person responsible for their safety. Children should be supervised to ensure that they do not play with the appliance.
- (2) This instruction manual is a universal manual, some functions are only applicable to particular product. All the illustrations and information in the instruction manual are only for reference, and control interface should be subject to actual operation.
- (3) In order to make the product better, we will continuously conduct improvement and innovation. We have the right to make necessary revision to the product from time to time due to the reason of sales or production, and reserve the right to revise the contents without further notice.
- (4) For personal injury or property loss and damage caused by improper operation such as improper installation and debugging,

unnecessary maintenance, violation of related national laws and rules and industrial standard, and violation of this instruction manual, etc., we will bear no liability.

- (5) The final right to interpret for this instruction manual belongs to Daitsu.



This marking indicates that this product should not be disposed with other household wastes throughout the EU. To prevent possible harm to the environment or human health from uncontrolled waste disposal, recycle it responsibly to promote the sustainable reuse of material resources. To return your used device, please use the return and collection systems or contact the retailer where the product was purchased. They can take this product for environmental safe recycling.

# Contents

1 SAFETY NOTICES (PLEASE BE SURE TO ABIDE ).....	1
2 OPERATION NOTICES .....	2
3 DISPLAY .....	3
3.1 LCD OF WIRED CONTROLLER.....	3
3.2 LCD DISPLAY INSTRUCTION.....	4
4 BUTTONS.....	7
4.1 BUTTON GRAPHICS.....	7
4.2 FUNCTION INSTRUCTION OF BUTTONS.....	7
5 INSTALLATION AND COMMISSIONING.....	8
5.1 INSTALLATION OF WIRED CONTROLLER.....	10
5.2 COMMISSIONING .....	21
6 OPERATION INSTRUCTIONS .....	31
6.1 ON/OFF .....	31
6.2 MODE SETTING .....	32
6.3 TEMPERATURE SETTING.....	33
6.4 FAN SETTING.....	34
6.5 TIMER SETTING.....	35
6.6 SWING SETTING.....	43
6.7 QUIET SETTING .....	44
6.8 SLEEP SETTING .....	47
6.9 AIR SETTING* .....	47
6.10 LIGHT ON/OFF SETTING.....	50
6.11 SAVE SETTING.....	51

6.12 FILTER CLEAN REMINDER SETTING .....	54
6.13 X-FAN SETTING .....	58
6.14 ABSENCE SETTING.....	59
6.15 REMOTE SHIELD FUNCTION .....	59
6.16 CHILD LOCK FUNCTION .....	60
6.17 GATE-CONTROL FUNCTION .....	60
<b>7 ERROR DISPLAY .....</b>	<b>60</b>
7.1 TABLE OF ERROR CODES FOR OUTDOOR UNIT .....	62
7.2 TABLE OF ERROR CODES FOR INDOOR UNIT .....	64
7.3 TABLE OF DEBUGGING CODES.....	65
7.4 TABLE OF STATUS CODES .....	67

# 1 SAFETY NOTICES (PLEASE BE SURE TO ABIDE )



Warning: If not abide strictly, it may cause severe damage to the unit or the people.



Note: If not abide strictly, it may cause slight or medium damage to the unit or the people.



This sign indicates that the operation must be prohibited. Improper operation may cause severe damage or death to people.



This sign indicates that the items must be observed. Improper operation may cause damage to people or property.



**WARNING!**

This product can't be installed at corrosive , inflammable or explosive environment or the place with special requirements, such as kitchen. Otherwise, it will affect the normal operation or shorten the service life of the unit, or even cause fire hazard or serious injury. As for above special places, please adopt special air conditioner with anti-corrosive or anti-explosion function .

## 2 OPERATION NOTICES

- ◆ The power supply for all indoor units must be unified.
- ◆ Prohibit installing the wired controller at wet or sunshine places.
- ◆ Do not knock, throw or frequently disassemble the wired controller.
- ◆ Do not operate the wired controller with wet hands.
- ◆ In one system network, you must set one indoor unit as the master indoor unit, Other indoor units are slave indoor units .
- ◆ The operation mode of the system is basing on that of master indoor unit. Master indoor unit can switch to any modes, while slave unit can't switch to the mode that is conflicting with master indoor unit.
- ◆ When master indoor unit changes mode which cause operation mode of slave indoor unit conflicts with that of system, the operation mode of slave unit will switch to the operate mode of system automatically.
- ◆ When two wired controllers control one (or more) indoor unit(s), the address of wired controller should be different.
- ◆ Functions with “\*” are optional for indoor units. If a function is not included in an indoor unit, wired controller can't set the function, or setting of this function is invalid to the indoor unit.



### 3 DISPLAY



Fig. 3.1 Appearance of wired controller

### 3.1 LCD OF WIRED CONTROLLER

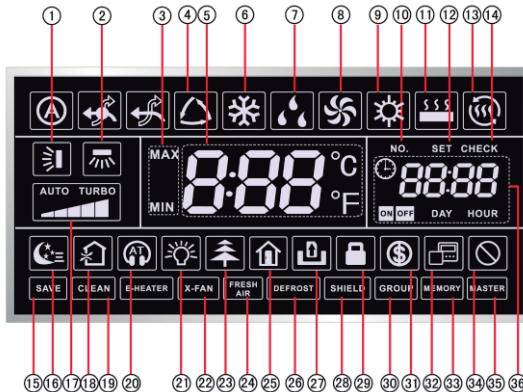

























Fig. 3.2 LCD graphics of wired controller













## 3.2 LCD DISPLAY INSTRUCTION

Table 3.1 LCD display instruction

No.	Symbols	Instructions
1		Up and down swing function
2	 *	Left and right swing function
3		It's valid under Save mode and displays during setting process. Temperature lower limit for Cooling: Limit the minimum temperature value under Cooling or Dry mode. Temperature upper limit for Heating: Limit the maximum temperature value under Heating, Space Heating or 3D Heating mode.
4	 *	Auto mode (Under Auto mode, the indoor units will automatically select their operating mode as per the temperature change so as to make the ambient comfortable.)
5		It shows the setting temperature value(In case the wired controller is controlling a Fresh Air Indoor Unit, then the temperature zone will display FAP)
6		Cooling mode
7		Dry mode
8		Fan mode
9		Heating mode

No.	Symbols	Instructions
10		When inquiring or setting project number of indoor unit, it displays "NO." icon
11		Floor Heating mode (When Heating and Floor Heating simultaneously shows up, it indicates 3D Heating is activated.)
12		Display "SET" icon under parameter setting interface
13		Space Heating mode
14		Display "CHECK" icon under parameter view interface
15		Outdoor unit operates under Save mode/upper limit of system capacitor less 100%/remote Save status
16		Sleep status
17		Current set fan speed (including auto, low speed, medium-low speed, medium speed, medium-high speed, high speed and turbo seven status)
18		Air status, Indoor unit optional function
19		Remind to clean the filter
20		Quiet status (including Quiet and Auto Quiet two status)
21		Light On/Off function
22		X-fan function
23		Health function, Indoor unit optional function

## Wired Controller CDV-46

No.	Symbols	Instructions
24		Reserved function
25		Absence function
26		Outdoor unit defrosting status
27		Gate-control function
28		Shielding status
29		Child Lock status
30		One wired controller controls multiple indoor units
31		Save status of indoor unit
32		It indicates the current wired controller is the slave wired controller (address of wired controller is 02)
33		Memory status (The indoor unit resumes the original setting state after power failure and then power recovery)
34		Invalid operation
35		Current wired controller connects master indoor unit
36		Timer zone: Display system clock and timer status
<p>Note: When wired controller is connected with different indoor units, some functions will be different</p>		

## 4 BUTTONS

### 4.1 BUTTON GRAPHICS

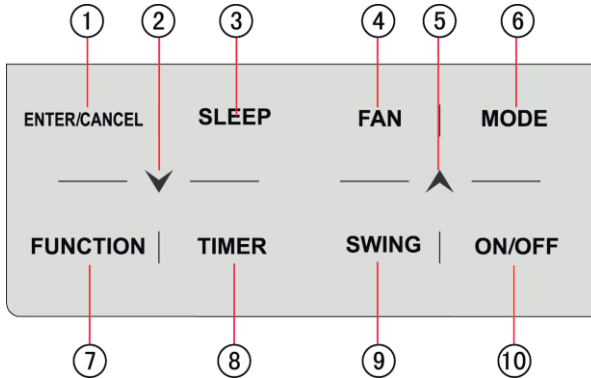





Fig. 4.1 Button graphics

### 4.2 FUNCTION INSTRUCTION OF BUTTONS

Table 4.1 Function instruction of buttons

No.	Buttons	Instructions
1	ENTER/CANCEL	Select and cancel function
2	▼	(1) Set operating temperature of indoor unit (2) Set Timer
5	▲	(3) Switch Quiet mode, Air grade, Clean grade, set upper and lower temperature limit under Save mode (4) Set and inquiry parameter

## Wired Controller CDV-46

No.	Buttons	Instructions
3	SLEEP	Set Sleep mode
4	FAN	Switch among auto, low speed, low-medium speed, medium speed, medium-high speed, high speed and turbo status
6	MODE	Switch Auto, Cooling, Dry, Fan, Heating, Floor Heating, 3D Heating and Space Heating modes for indoor unit. (Note: The Floor Heating, 3D Heating and Space Heating function icon will show up when the unit has those functions.)
7	FUNCTION	Switch among Air, Quiet, Light, Health, Absence, Save, Clean, and X-fan functions.
8	TIMER	Timer setting
9	SWING	Set up and down swing status
10	ON/OFF	Indoor unit On/Off
2+5		Simultaneously press “  ” and “  ” for 5s to enter or cancel the Child Lock function.

## 5 INSTALLATION AND COMMISSIONING

There're two editions of wired controller. The parts of wired controller are different.

Edition one :

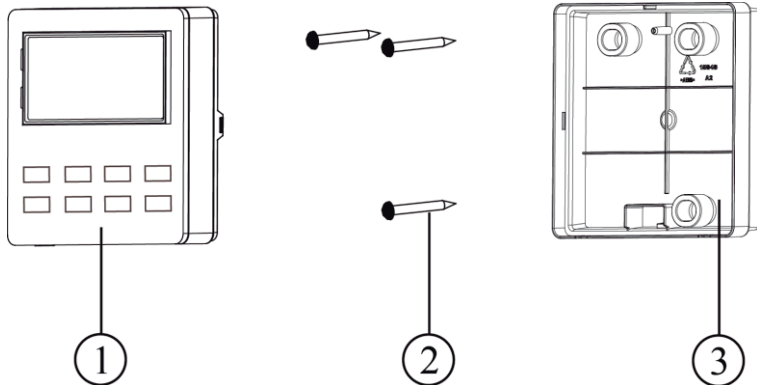
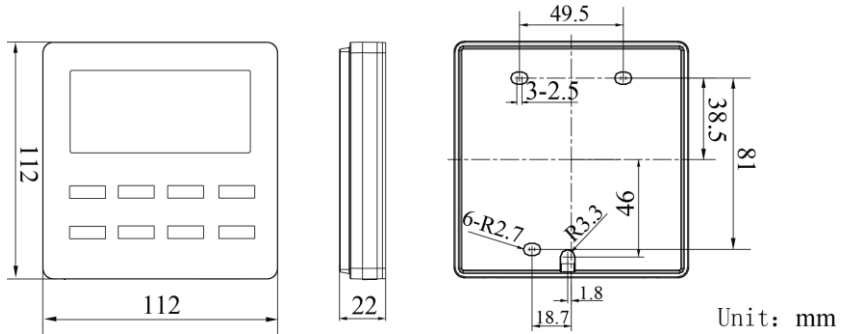

Fig. 5.1.1 Parts of wired controller

No.	1	2	3
Name	Panel of wired controller	Self-tapping Screw ST3.9X25 MA	Soleplate of wired controller
Q'ty	1	3	2

Edition Two :

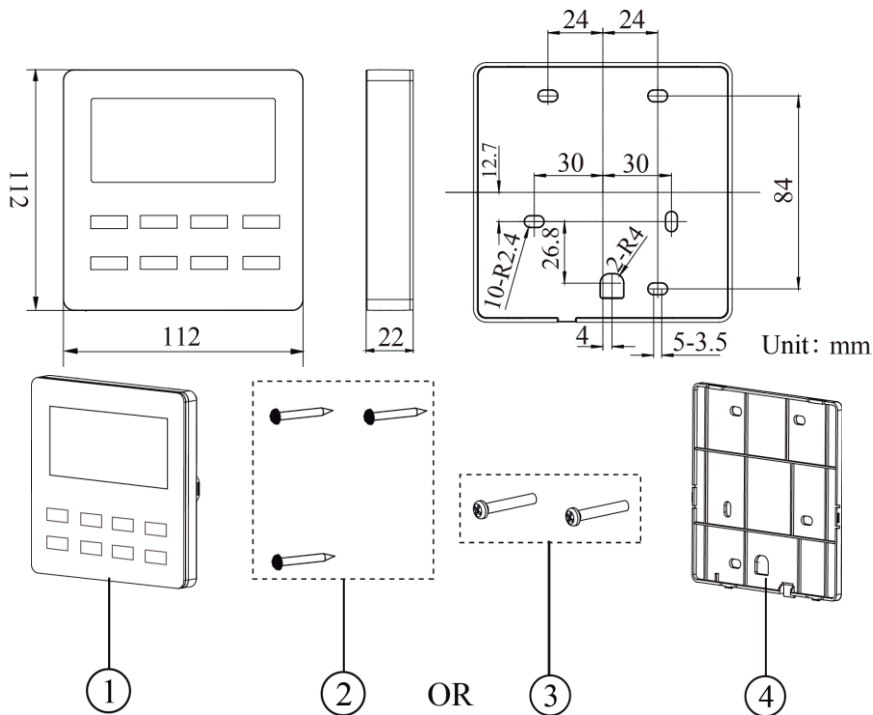

Fig. 5.1.2 Parts of wired controller

No.	1	2	3	4
Name	Panel of wired controller	Self-tapping Screw ST3.9X25 MA	Screw M4×25	Soleplate of wired controller
Q'ty	1	3	2	1



## 5.1 INSTALLATION OF WIRED CONTROLLER

### 5.1.1 Communication Line Selection

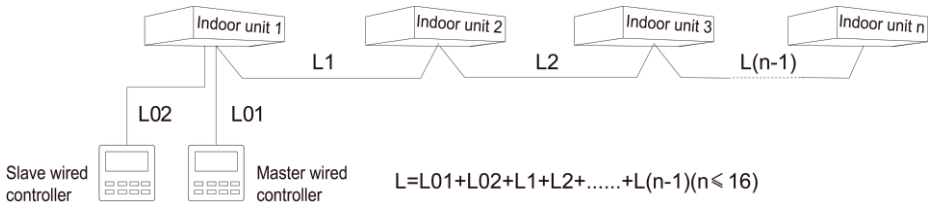

Fig. 5.2 Length of communication line

Wire material type	Total length of communication line between indoor unit and wired controller L (m/feet)	Wire size (mm <sup>2</sup> /AWG)	Material standard	Remarks
Light/Ordinary Polyvinyl chloride sheathed cord. (60227 IEC 52 /60227 IEC 53)	$L \leq 250\text{m}$ ( $L \leq 820-1/5\text{feet}$ )	$2 \times 0.75 \text{ mm}^2 \sim 2 \times 1.25 \text{ mm}^2$ ( $2 \times \text{AWG}1$ $8 \sim 2 \times \text{AWG}16$ )	IEC 60227-5:2 007	(1)Total length of communication line can't exceed 250m (820-1/5feet). (2)The cord shall be Circular cord (the cores shall be twisted together). (3)If unit is installed in places with intense magnetic field or strong interference, it is necessary to use shielded wire.

#### Note:

- ① If the air conditioner is installed at the strong electromagnetic interference place, communication line of the wired controller must use shielding twisted pair.

- ② Materials of communication line for wired controller must be selected according to this instruction manual strictly

## 5.1.2 Installation requirements

- (1) Prohibit installing the wired controller at wet places.
- (2) Prohibit installing the wired controller at direct sunshine places.
- (3) Prohibit installing the wired controller at the place near high temperature objects or water-splashing places.
- (4) Prohibit installing the wired controller at the place where faces forward to the window. Prevent abnormal work due to the interference from the other wired controller around.

## 5.1.3 Wiring Requirements

There are four network wiring methods between wired controller and indoor unit:

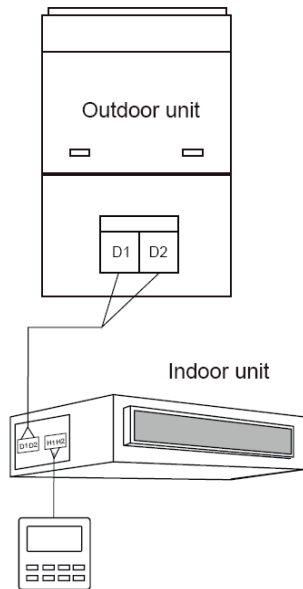

Fig. 5.3 One wired controller controls one indoor unit

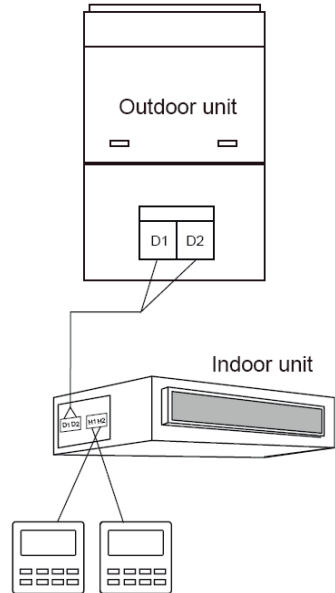

Fig. 5.4 Two wired controllers control one indoor unit

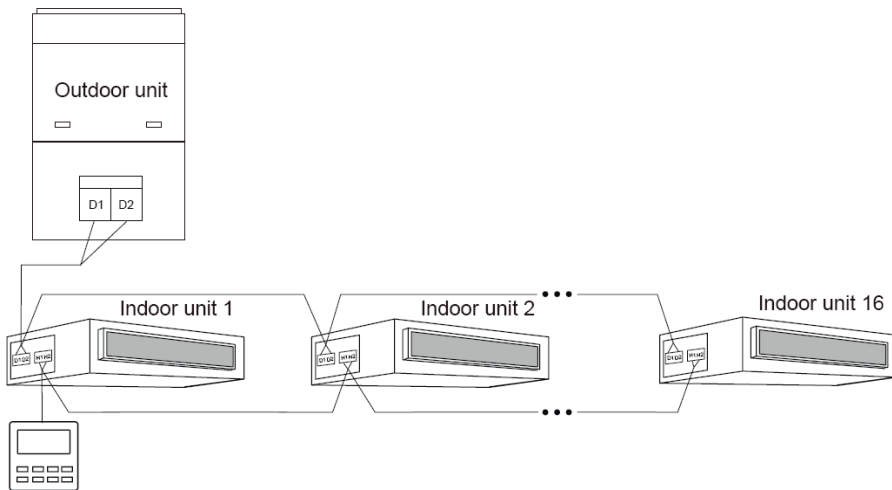

Fig. 5.5 One wired controller controls multiple indoor units simultaneously

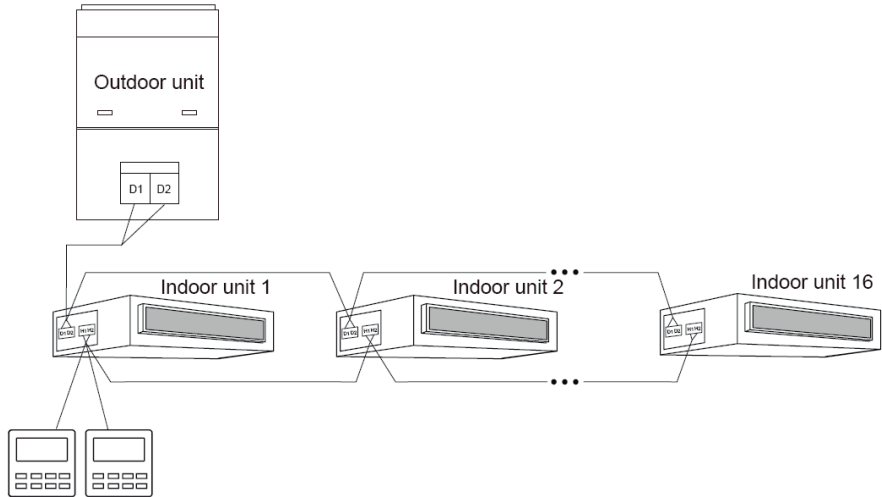

Fig. 5.6 Two wired controllers control multiple indoor units simultaneously

#### Wiring instructions:

- (1) When one wired controller controls multiple indoor units simultaneously, the wired controller can connect to any one indoor unit, but the connected indoor unit must be the same series indoor unit. The total quantity of indoor unit controlled by wired controller can't exceed 16 sets, and the connected indoor unit must be within the same indoor unit's network. Wire controller must set quantity of group control indoor units. Please refer to 5.2.3 Parameters Setting.
- (2) When two wired controllers control one indoor unit, the addresses of those two wired controllers should be different. Please refer to 5.2.3 parameter setting.

- (3) When two wired controllers control multiple indoor units, wired controller can connected to any one indoor unit, while the connected indoor unit should be the same series indoor unit. The addresses of those two wired controllers should be different. Please refer to 5.2.3 parameter setting. The total quantity of indoor unit controlled by wired controller can't be more than 16 sets and all connected indoor units must be within the same indoor unit network. Wire controller must set quantity of group control indoor units. Please refer to 5.2.3 Parameters Setting.
- (4) When one (or two) wired controller(s) control(s) multiple indoor units at the same time, the controlled indoor unit's setting should be the same.
- (5) Wiring of wired controller and indoor unit network must be according to one of the four wiring method as shown in fig 5.3-5.6. As for the connection method shown in fig 5.4 and 5.6, there should be only one master wired controller (address is 01) and one slave wired controller (address 02). The quantity of wired controller can't exceed two.

Note:

Series of indoor units include:①Common Multi VRF Units;②Fresh Air Units;③ Double-heat Sources Units;④Combined Units; Except for fresh air units, double-heat sources units and combined units, the rest of indoor units belong to common multi VRF units.

## 5.1.4 Installation

There're two editions of wired controller. The Installation way is different.

Installation way one :

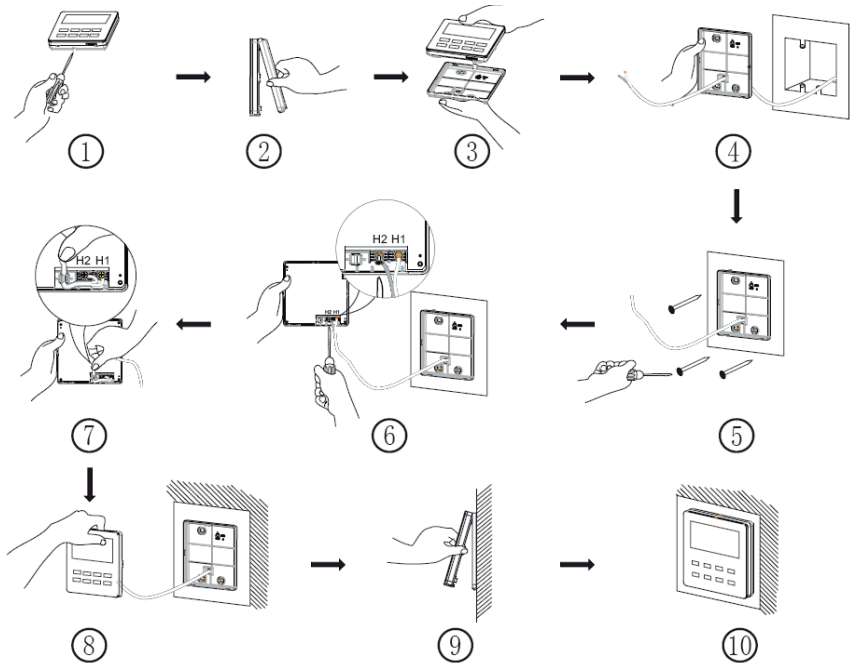

Fig. 5.7 Installation diagram for wired controller

Fig. 5.7 is the simple installation process of wired controller; please pay attention to the following items:

- (1) Before installation, please cut off the power for indoor unit.
- (2) Pull out the two-core twisted pair from the installation hole on wall, and then pull this wire through the "□" shape hole at the rear side of Soleplate of wired controller.
- (3) Stick the bottom plate of wired controller on the wall and then use Self-tapping Screw ST3.9X25 MA to fix Soleplate and installation hole on wall together.
- (4) Connect two-core twisted pair to H1 and H2 wiring column and then fix the screws.
- (5) Set two-core into the groove at left side of wiring column, and then bundle panel and Soleplate of wired controller together.

Note: If the wire size of the selected communication line is too large, you can peel some sheath layer of communication wire to satisfy installation requirements.

Installation way two :



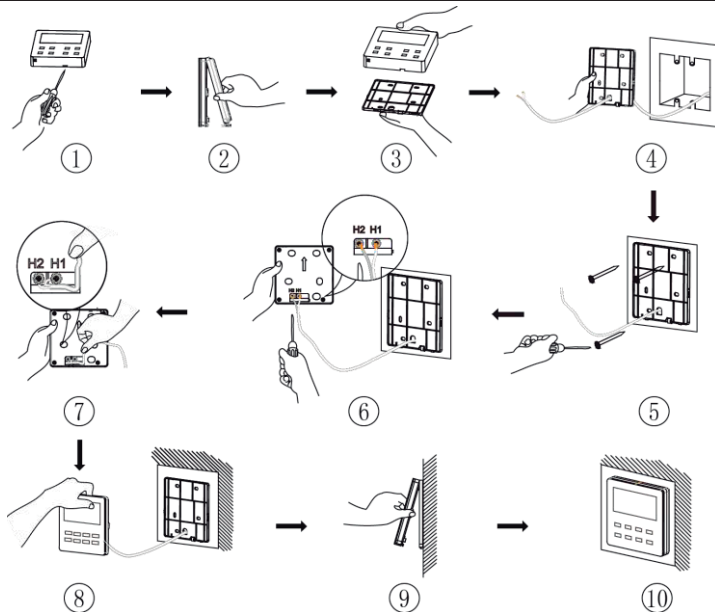

Fig. 5.8 Installation diagram for wired controller

Fig. 5.8 is the simple installation process of wired controller; please pay attention to the following items:

- (1) Before installation, please cut off the power for indoor unit.
- (2) Pull out the two-core twisted pair from the installation hole on wall, and then pull this wire through the "□" shape hole at the rear side of Soleplate of wired controller.

(3) Stick the bottom plate of wired controller on the wall and then use Self-tapping Screw ST3.9X25 MA or Screw M4×25 to fix Soleplate and installation hole on wall together.

(4) Connect two-core twisted pair to H1 and H2 wiring column and then fix the screws.

(5) Tidy up the lines in slot on the back of the panel, and then bundle the front panel of wired controller to its soleplate and the installation is completed.

Note: If the wire size of the selected communication line is too large, you can peel some sheath layer of communication wire to satisfy installation requirements.

### 5.1.5 Disassembly

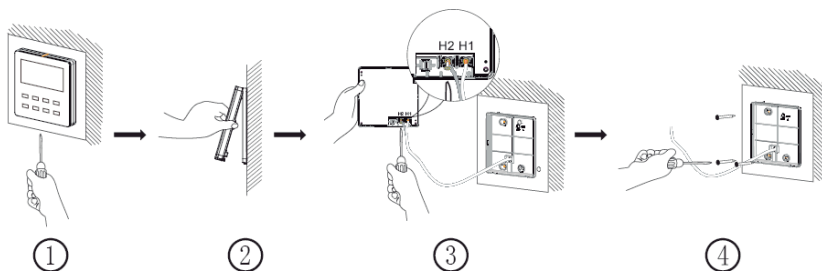

Fig. 5.9 Disassembly diagram of wired controller

## 5.2 COMMISSIONING

### 5.2.1 Set Master Indoor Unit

Under Off status, long press MODE button for 5s to set the corresponding indoor unit of wired controller as master indoor unit. “MASTER” icon will be light after finishing setting.

Note:

- ① There is a master indoor unit in a system, other slave indoor units can be set as master unit, in which case, the original master unit will become a slave unit.
- ② In one system, only one set of master indoor unit is allowed. If system detects that there are several master units, it will designate the unit with the smallest project number as a master unit.

### 5.2.2 Parameter Enquiry

Unit parameters can be checked in unit On or Off status.

- (1) Long press “FUNCTION” button for 5s to enter the interface of viewing unit parameters. “C00” is displayed in temperature zone and “CHECK” icon is light;
- (2) Press “▲” or “▼” button to select parameter code;
- (3) Press “ENTER/CANCEL” button to return to last step until exits viewing parameters.

The parameter enquiry list is as following:

Table 5.1 Parameters viewing list

Parameter code	Parameter name	Parameter range	Viewing method
C00	Entrance of adjustable parameter	--	In "C00" status, Timer zone shows the current indoor unit project number. When one wired controller is controlling multiple indoor units, then only the smallest project number will be displayed.
C01	View the project number of indoor unit and locate the faulted indoor unit	1-255; Project number of online indoor unit	<p>Operation method: Enter viewing, press MODE button in "C01" status to enter the interface of viewing indoor unit project number. Press "▲" or "▼" button to select the project number of indoor unit.</p> <p>Display method: Temperature zone: displays error codes of the current indoor unit( The temperature zone will display the error codes in turn with an interval of 3 seconds if there are several malfunctions in one indoor unit.) Timer zone: displays present indoor unit project number /C5 malfunction of project number conflict</p> <p>Note: 1) If master indoor unit exists in current indoor unit network, "MASTER" icon will be bright under "C01" interface. After entering the interface of viewing project number, "MASTER" icon will be bright only when the project number of master indoor unit is selected. 2) System will not exit "C01" viewing automatically. User has to exit this interface manually.</p>
C03	View the indoor unit quantity of the system network	1-80	Timer zone: display indoor unit quantity of the system

Parameter code	Parameter name	Parameter range	Viewing method
C06	View priority operation	00: normal operation 01: priority operation	<p>Operation method: Enter viewing: press MODE button in “C06” status to enter the interface of viewing priority operation. Press “▲” or “▼” button to select indoor unit.</p> <p>Display method: Temperature zone: displays current indoor unit project number; Timer zone: displays current priority operation setting value of indoor unit.</p>
C07	View indoor ambient temperature	--	<p>Operation method: Enter viewing: press MODE button in “C07” status to enter the interface of viewing indoor ambient temperature. Press “▲” or “▼” button to select indoor unit.</p> <p>Display method: Temperature zone: displays current indoor unit project number; Timer zone: displays indoor ambient temperature.</p>
C08	View Filter Clean Reminder time	4-416: days	Timer zone: displays Filter Clean Reminder time
C09	View address of wired controller	01, 02	Timer zone: displays the address of wired controller

## Wired Controller CDV-46

Parameter code	Parameter name	Parameter range	Viewing method
C11	View the indoor unit quantity in the case that one wired controller controls several indoor units at the same time	1-16	Timer zone: displays the indoor unit quantity controlled by the wired controller
C12	View outdoor ambient temperature	-	Timer zone: displays outdoor ambient temperature
C17	View indoor relative humidity	20~90 relative humidity20 %~90%	<p>Operation method: Enter into review process and press "MODE" button to enter into the review interface of indoor relative humidity under C17 status. Press "▲" or "▼" button to switch the number of indoor unit.</p> <p>Display method: Temp area: display current indoor unit's project number Timer zone: display indoor relative humidity</p>

Parameter code	Parameter name	Parameter range	Viewing method
C18	One-button viewing of indoor unit project number	1-255:Project Number of online indoor unit	<p>Operation method:  Enter viewing, short-press "MODE" button in "C18" status to turn on the function of one-button viewing indoor unit project code, and the wired controller will enter the interface of viewing indoor unit project code. Press "▲" or "▼" button to select the indoor unit.</p> <p>Display method:  Temperature zone: displays number of the current indoor unit  Timer zone: displays project number of indoor unit</p> <p>Note:  1) After turning on the one-button viewing function, each wired controller of the entire system will display the project number of its controlling indoor unit on its timer zone. (The timer zone will display different project numbers in turn with an interval of 3 seconds if one wired controller is controlling multiple indoor units.)  2) Slave wired controller cannot view "C18".</p> <p>Cancel method:  1) If user exits the "C18" interface manually, the one-button viewing function will be immediately turned off.  2) If system exits the "C18" interface due to no action in 20 seconds, user has to press the "ON/OFF" button under on/off status to cancel this function.  3) After the one-button viewing function is turned on, pressing the "ON/OFF" button of any wired controller of the same system network under on/off status will cancel this function.</p>

Parameter code	Parameter name	Parameter range	Viewing method
C20	View the air outlet temperature of Fresh Air Indoor Unit*	--	<p>Operation method: Enter viewing, short-press "MODE" button in "C20" status to enter the interface of viewing air outlet temperature of Fresh Air Indoor Unit. Press "▲" or "▼" button to select the indoor unit.</p> <p>Display method: Temperature zone: displays current indoor unit project number Timer zone: displays air outlet temperature of Fresh Air Indoor Unit Note: only applicable to Fresh Air Indoor Unit.</p>

**Note:**

- ① Under parameter viewing status, FAN, TIMER, SLEEP and SWING buttons are invalid. Press "ON/OFF" button to go back to the home page, while not to turn on/off the unit.
- ② Under parameter viewing status, the signal from remote controller is invalid.

### 5.2.3 Parameter Setting

Unit parameters can be set in unit On or Off status.

- (1) Long press FUNCTION button for 5s and the temperature zone displays "C00"; long press FUNCTION button for another 5s to enter the interface of setting wired controller parameters. "P00" is displayed in temperature zone;
- (2) Press "▲" or "▼" button to select parameter code. Press MODE button to enter parameter setting. At that time, parameter value is blinking. Press "▲" or "▼" button to adjust the parameter value and press ENTER/CANCEL button to



finish setting.

(3) Press ENTER/CANCEL button to return to last step until exists setting parameters.

The parameter setting list is as following:

Table 5.2 Parameter setting list

Parameter code	Parameter name	Parameter range	Default value	Note
P10	Set master indoor unit	00: do not change current master/slave state of indoor unit 01: set current indoor unit as master indoor unit	00	When set the corresponding indoor unit of wired controller as master indoor unit, "MASTER" icon will be bright after finishing setting.
P11	Set infrared receiver of wired controller	00: forbidden 01: activated	01	It can be set only through master wired controller. When infrared receiver of wired controller is forbidden, the wired controller can't receive the signal from remote controller and it is operated through buttons.
P13	Set address of wired controller	01: master wired controller 02: slave wired controller	01	When two wired controllers control one indoor unit (or several indoor units), the addresses of the two wired controllers should be different. Assistant wired controller (02) is without unit parameter setting function except setting its address.

## Wired Controller CDV-46

Parameter code	Parameter name	Parameter range	Default value	Note
P14	Set quantity of group control indoor units	00: forbid this function 01-16: indoor unit quantity	01	Set the corresponding value according to the connected indoor unit quantity.
P16	Set unit of temperature	00:Celsius 01:Fahrenheit	00	--
P30	Set static pressure of indoor fan motor	01-09: static pressure level of indoor fan motor	05	There are two kinds of static pressure level: 5 levels: 03, 04, 05, 06, 07 9 levels: 01, 02, 03, 04, 05, 06, 07, 08, 09 Wired controller can be adapted to the different types of indoor units that it possesses 1-9 level selection for setting static pressure. When the indoor unit with 5 static pressure levels received the level setting sent by wired controller is less than 3, it will be settled as the 3rd level; if it is over 7, it will be settled as the 7th level.
P31	High ceiling installation*	00: installation height of standard ceiling 01: installation height of high ceiling	00	Only applicable to cassette units
P33	Set Timer	00: general timer 01: clock timer	00	--

Parameter code	Parameter name	Parameter range	Default value	Note
P34	Clock Timer repetition is valid	00: once 01: repeat everyday	00	Available only when timer is set to clock timer.
P37	Cooling setting temperature under auto mode	17°C~30°C(63°F~86°F)	25°C(77°F)	When the temperature unit is °C, cooling setting temperature minus heating setting temperature ≥ 1°C. When the temperature unit is °F, cooling setting temperature minus heating setting temperature ≥ 2°F.
P38	Heating setting temperature under auto mode	16°C~29°C(61°F~84°F)	20°C(68°F)	
P43	Set priority operation	00: normal operation 01: priority operation	00	When power supply is insufficient, the indoor units which are set to priority operation can operate, while other indoor units are forced to be turned off.
P46	Clear Filter Clean accumulated time	00: do not clear 01: clear	00	--
P49	Opening angle of indoor unit air-return plate*	01: angle 1(25°) 02: angle 2(30°) 03: angle 3(35°)	01	Only applicable to units with air-return plate

## Wired Controller CDV-46

Parameter code	Parameter name	Parameter range	Default value	Note
P50	Air outlet temperature setting for Fresh Air Indoor Unit in cooling*	16°C~30°C(61F ~ 86F )	18°C (64°F)	Only applicable to Fresh Air Indoor Unit
P51	Air outlet temperature setting for Fresh Air Indoor Unit in heating*	16°C~30°C(61F ~ 86F )	22°C (71°F)	Only applicable to Fresh Air Indoor Unit
P54	Union setting of Fresh Air Indoor Unit*	00: without union control 01: with union control	00	After union function is set, Fresh Air Indoor Unit will be turned on/off following the on/off status of common indoor unit. Besides, Fresh Air Indoor Unit can also be turned on/off manually. Note: only applicable to Fresh Air Indoor Unit.

### Note:

- ① Under parameter setting status, FAN, TIMER, SLEEP and SWING button are invalid. Press ON/OFF button to go back to home page, but not turning on/off the unit.
- ② Under parameter setting status, the signal from remote controller is invalid.

## 6 OPERATION INSTRUCTIONS

### 6.1 ON/OFF

Press ON/OFF button to turn on the unit. Press ON/OFF button again to turn off the unit. The interfaces of On/Off status are shown in fig. 6.1 ~ 6.4.

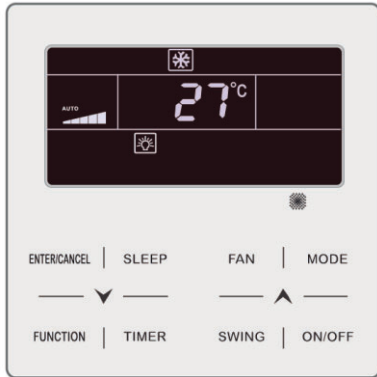

Fig. 6.1 Interface of On status in Celsius    Fig. 6.2 Interface of Off status in Celsius



Fig. 6.3 Interface of On status in Fahrenheit





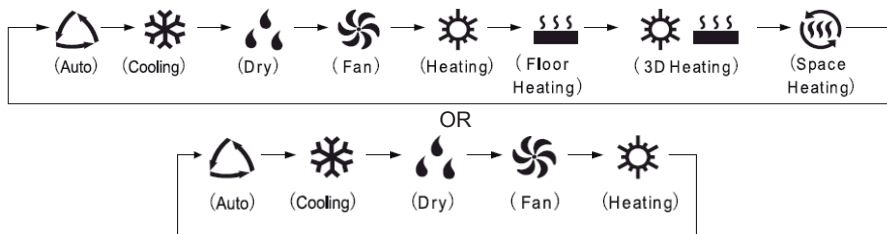

Fig. 6.4 Interface of Off status in Fahrenheit

## 6.2 MODE SETTING





Under On status, pressing MODE button can set mode circularly as:



**Note:**

- ① the available modes are different for different models, the wired controller will automatically select mode setting range according to the model of indoor unit.
- ② The Auto mode can be only set at the master indoor unit.
- ③ Under Auto mode, if the indoor unit is running under Cooling, the icons “” and “” will light up; if the indoor unit is running under Heating, the icons “” and “” will light up.

## 6.3 TEMPERATURE SETTING

Pressing “” or “” button in On status increases or decreases set temperature by 1°C or 1F ; holding “” or “” button increases or decreases set temperature by 1°C or 1F every 0.3s.

In Cooling, Fan, Heating, Floor Heating, 3D Heating or Space Heating mode, temperature setting range is 16°C~30°C or 61F ~86F .

In Dry mode, the temperature setting range is 12°C or 54F , 16°C~30°C or 61F ~86F . In Dry mode, when temperature is 16°C or 61F , continuously press “” button twice to decrease temperature to 12°C or 54F (when save function is activated, the temperature in Dry mode can't be adjusted to 12°C or 54°F and the setting range is “lowest temperature in Save mode” ~ 30°C or 86F ).

**Note:**

- ① Under Auto mode or Absence function is activated, the setting temperature

can not be adjusted by pressing “▲” or “▼”.

- ② When the wired controller is connected with a Fresh Air Indoor Unit, fresh air indoor unit code “FAP” will be displayed as shown below. Setting temperature won’t be displayed and can’t be adjusted via “▲” or “▼” button. The air outlet temperature in cooling or heating can only be set in the parameter setting status.



## 6.4 FAN SETTING

- (1) Under On status, pressing FAN button can set fan speed circularly as:





## (2) Turbo function setting

Start turbo function: In unit on status, press “FUNCTION” button to switch to Turbo function with Turbo function icon “**TURBO**” blinking, and then press “ENTER/CANCEL” button to start Turbo function. When Turbo function is activated, Turbo function icon “” will be bright.

Cancel Turbo function: When Turbo function is activated, press “FUNCTION” button to switch to Turbo function with Turbo function icon “**TURBO**” blinking, and then press “ENTER/CANCEL” button to cancel Turbo function ; Press “FAN” button to cancel turbo function and start auto speed.

Note:

- ① In Dry mode, fan speed is low and can't be adjusted.
- ② When the wired controller is connected with a Fresh Air Indoor Unit, fan speed of indoor unit will be high fan speed only. Fan speed of indoor unit can't be adjusted via “FAN” button.
- ③ If indoor unit's fan speed is set auto, indoor unit will change fan speed automatically according to room temperature in order to make the room temperature more stable and comfortable.

## 6.5 TIMER SETTING

The wired controller is equipped with two kinds of timer: general timer and clock timer. General timer is factory defaulted setting. Please refer to Section 5.2.3 for the timer setting way.

## 6.5.1 General Timer

Unit On/Off after a desired hour can be set through general timer.

Set Timer: when timer is not set, press TIMER button to enter timer setting and “HOUR” icon is blinking. Press “▲” or “▼” button to adjust timer time. Press TIMER button to save the setting and then exit setting.

Cancel Timer: when timer is set, press TIMER button to cancel it.

Timer setting range: 0.5~24h. Pressing “▲” or “▼” button increases or decreases timer time by 0.5h; holding “▲” or “▼” button increases or decreases timer time by 0.5h every 0.3s.

In unit On status, timer Off setting is as shown in fig. 6.5 or 6.6.

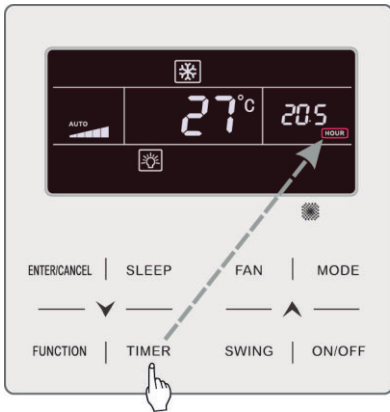

Press TIMER button to set timer

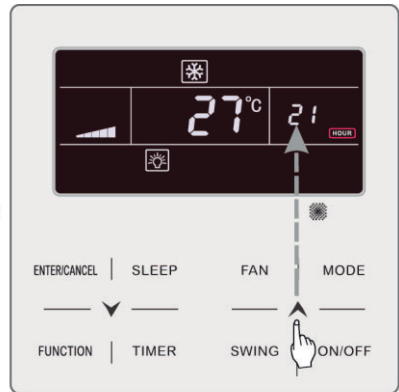

Press “▲” or “▼” button to adjust timer time

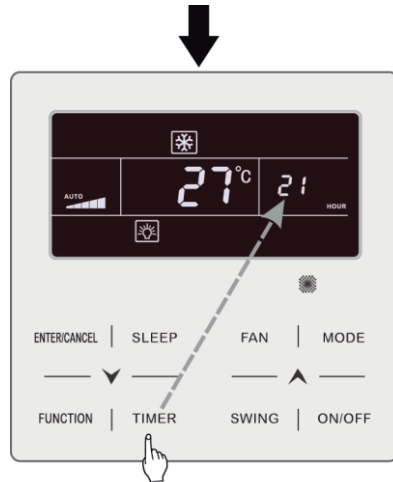

Press TIMER button to finish timer setting

Fig. 6.5 Timer Off setting in unit On status in Celsius

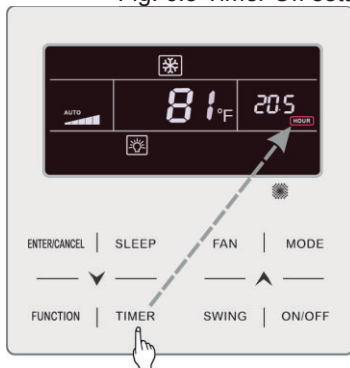

Press TIMER button to set timer

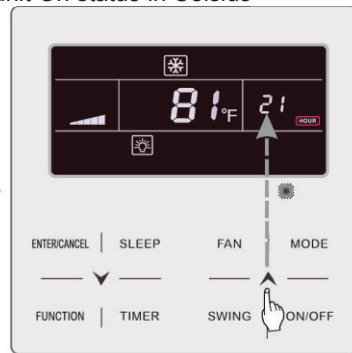

Press "▲" or "▼" button to adjust timer time

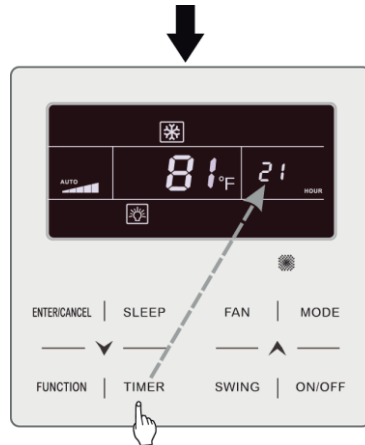

Press TIMER button to finish timer setting

Fig. 6.6 Timer Off setting in unit On status in Fahrenheit

## 6.5.2 Clock Setting

Clock display: when the timer setting way is clock timer, timer zone displays system clock in unit On and Off status. “🕒” icon is bright and the clock can be set at this time.

Clock setting: long press TIMER button for 5s to enter clock setting and “🕒” icon is blinking. Pressing “▲” or “▼” button increases or decreases clock time by 1min; holding “▲” or “▼” button for 5s increases or decreases clock time by 10min; Press ENTER/CANCEL button or TIMER button to save the setting and then exit setting.

### 6.5.3 Clock Timer

Unit On/Off at a certain time can be set through clock timer.

Set Timer:

- (1) Press TIMER button to enter timer on setting and the “ON” icon is blinking;
- (2) Press “▲” or “▼” button to adjust unit On time. Press ENTER/CANCEL button to finish setting;
- (3) Before pressing ENTER/CANCEL button, pressing TIMER button can save unit On time and then switch to unit Off time setting with “OFF” icon blinking;
- (4) Press “▲” or “▼” button to adjust unit Off time. Press ENTER/CANCEL button to finish setting;

Cancel Timer:

Press TIMER button to enter timer setting; press TIMER button again to switch to the setting of unit ON time or unit Off time; press ENTER/CANCEL button to cancel timer.

Pressing “▲” or “▼” button increases or decreases timer time by 1min; holding “▲” or “▼” button for 5s increases or decreases timer time by 10min.

Clock Timer setting is as shown in fig. 6.7 or 6.8:



Unit is on and timer is not set



Press TIMER button to set unit On time



Press TIMER button to switch to unit Off time setting

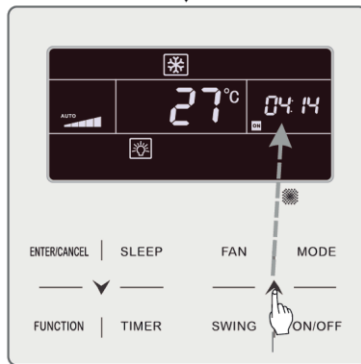

Press "▲" or "▼" button to adjust unit On time

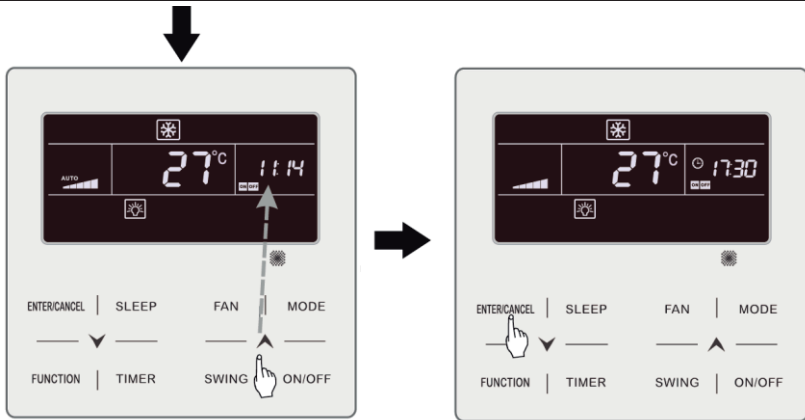

Press “^” or “v” button to adjust unit Off time

Press ENTER/CANCEL button to finish setting

Fig. 6.7 Unit On/Off time setting in unit On status in Celsius

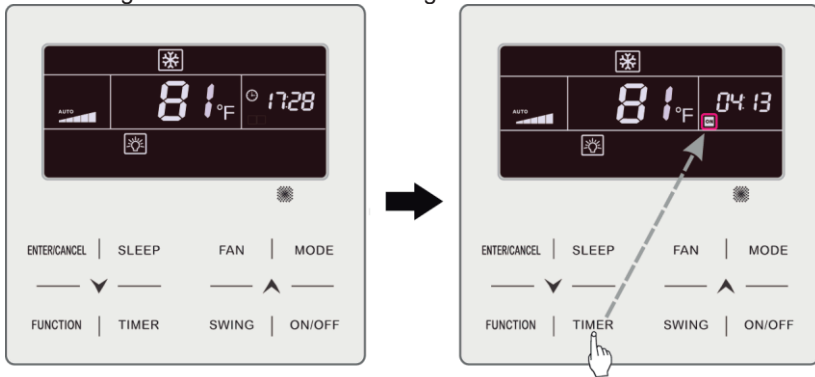

Unit is on and timer is not set

Press TIMER button to set unit On time

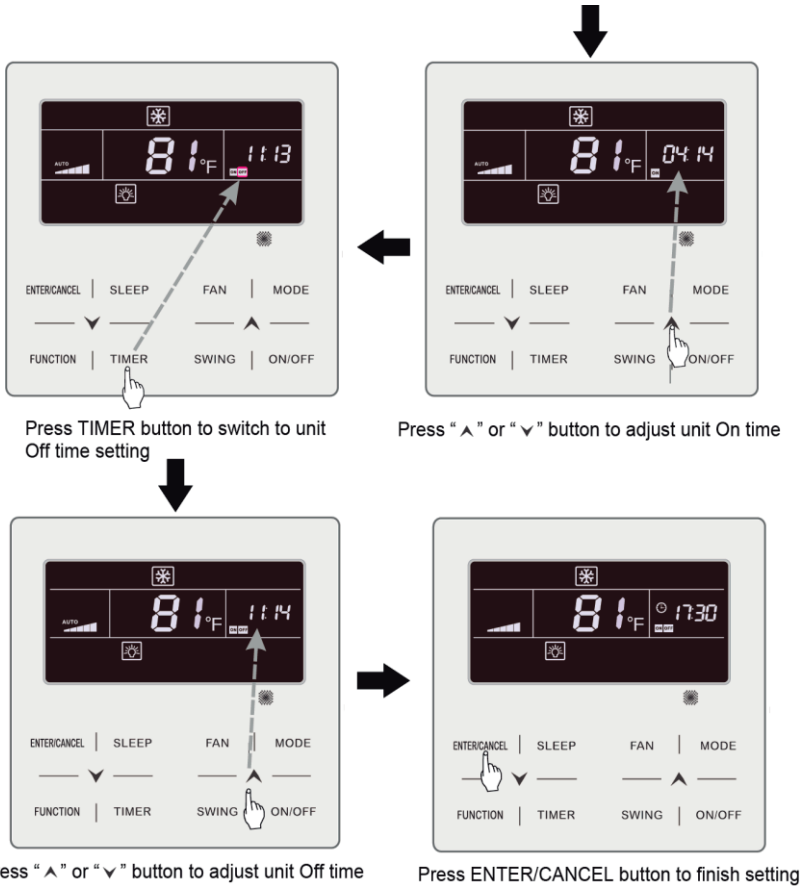



Fig. 6.8 Unit On/Off time setting in unit On status in Fahrenheit



## 6.6 SWING SETTING

In unit on status, up & down swing function and left & right swing function can be set.

### (1) Up & down swing function



Up & down swing function has two modes: simple swing mode and fixed-angle swing mode. In unit off status, press “SWING” button and “▲” button together for 5 seconds to switch between simple swing mode and fixed-angle swing mode. Up & down swing icon  will blink during switching.

1) When simple swing mode is set in unit on status, press “SWING” button to start or stop up & down swing.

2) When fixed-angle swing mode is set in unit on status, press “SWING” button to adjust swing angle circularly as below:







### (2) Left & right swing function\*:

Start left & right swing: In unit on status, press “FUNCTION” button to switch to left & right swing function with left & right swing icon  blinking, and then press “ENTER/CANCEL” button to start left & right swing. When left & right swing is activated, left & right swing icon  will be bright.

Cancel left & right swing: When left & right swing is activated, press “FUNCTION” button to switch to left & right swing with left & right swing icon  blinking, and then press “ENTER/CANCEL” button to cancel left & right swing.

## 6.7 QUIET SETTING

Quiet Function: decrease the noise of indoor unit and achieve the quiet effect. Quiet function has two modes: Quiet mode and Auto Quiet mode. It is available only in Auto, Cooling, Dry, Fan, Heating, 3D heating, Space heating mode.

Turn on Quiet Function: press FUNCTION button to turn to Quiet function and then Quiet icon “” or auto quiet icon “” is blinking. At this moment, press “” or “” button to switch between quiet and auto quiet, and then press ENTER/CANCEL button to activate.

Turn off Quiet Function: press FUNCTION button to turn to Quiet function and then press ENTER/CANCEL button to cancel Quiet function.

The setting of Quiet function is as shown in fig. 6.9 or 6.10:

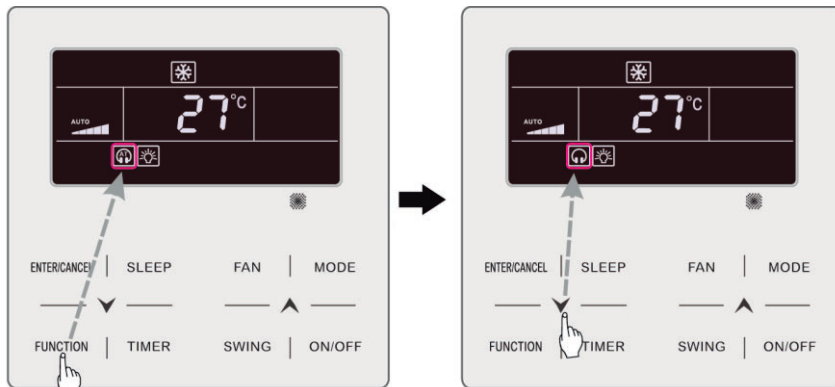

Press FUNCTION button to turn to Quiet function

Press “” or “” button to switch between Quiet and Auto Quiet

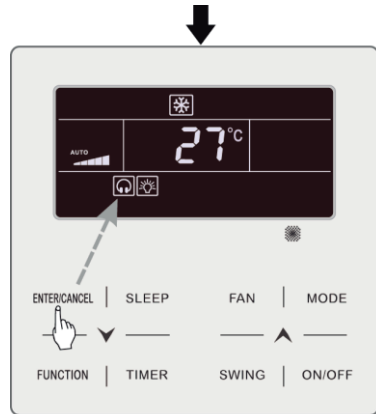

Press ENTER/CANCEL button to activate Quiet function

Fig. 6.9 Setting of Quiet function in Celsius

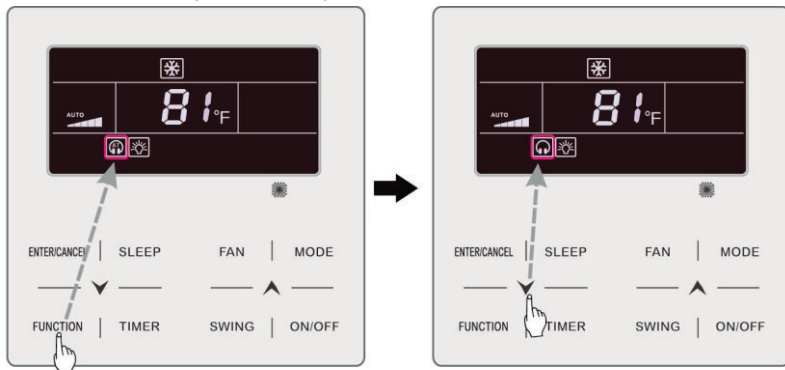

Press FUNCTION button to turn to Quiet function

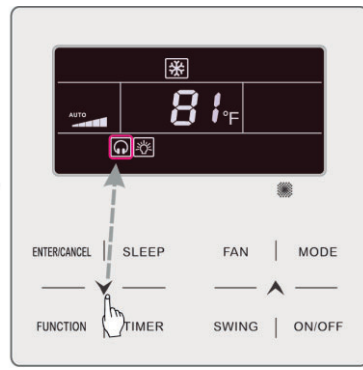

Press "▲" or "▼" button to switch between Quiet and Auto Quiet

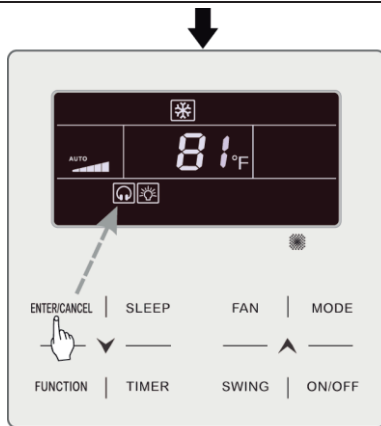

Press ENTER/CANCEL button to activate Quiet function

Fig. 6.10 Setting of Quiet function in Fahrenheit

**Note:**

- ① When Quiet function is enabled, indoor unit will operate at quiet fan speed. Fan speed is lowered so as to reduce the noise of indoor fan motor.
- ② When Auto Quiet function is enabled, indoor unit will change fan speed automatically according to room temperature. After room temperature reaches a set point, unit will operate at quiet fan speed.

## 6.8 SLEEP SETTING

Sleep Function: in this mode, the unit will operate according to the preset sleep curve to provide comfortable sleep environment.

Turn on/off Sleep Function: in unit On status, press SLEEP button to activate. or cancel Sleep function.



When Sleep function is activated, “” icon is bright and quiet or auto quiet mode is also activated.

When Sleep function is closed, if quiet function is activated before starting Sleep function, only sleep function is closed while quiet function is still activated;

Under Auto, Fan or Floor Heating mode, this Sleep function is not available.

## 6.9 AIR SETTING\*

Air Function: Adjust the amount of indoor fresh air to improve air quality and keep indoor air fresh.

Turn on Air Function: When unit is on or off, press FUNCTION button and select Air. “” icon will blink and the unit enters into Air setting. Temperature zone shows the level of Air setting, which can be adjusted by pressing “” or “” button. The adjustment range is 1~10. Press ENTER/CANCEL button to turn on Air function.

Turn off Air Function: When Air function is on, press FUNCTION button to select Air, then press ENTER/CANCEL button to cancel this setting.

Fig.6.11 or 6.12 Shows how to turn on Air function:

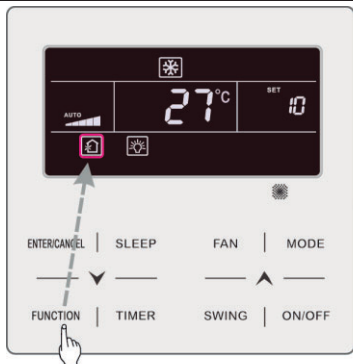

Press FUNCTION button and select Air

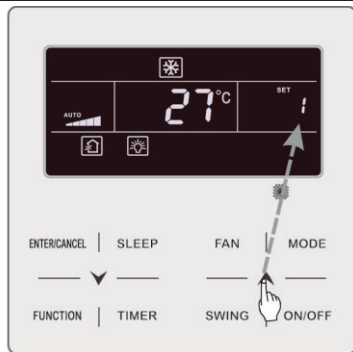

Press "▲" or "▼" button to adjust the level of Air setting

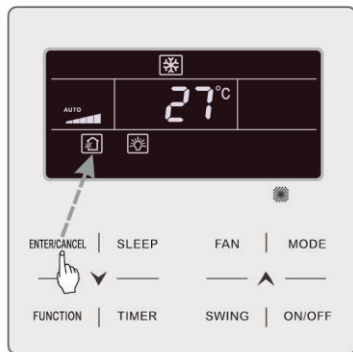

Press ENTER/CANCEL button to turn on Air function

Fig.6.11 Turn on Air Function in Celsius

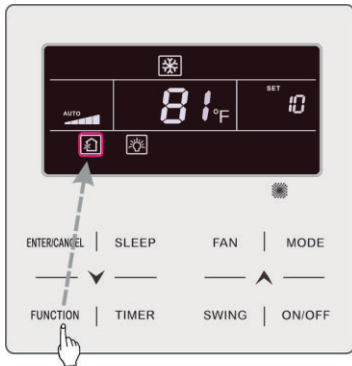

Press FUNCTION button and select Air

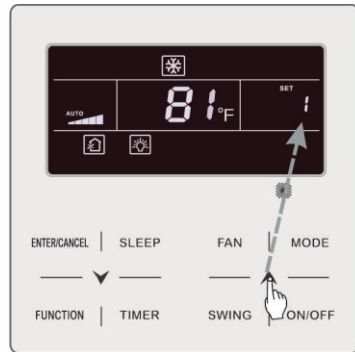

Press "▲" or "▼" button to adjust the level of Air setting

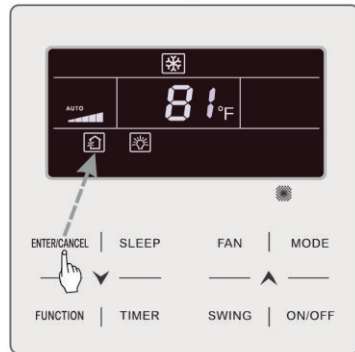

Press ENTER/CANCEL button to turn on Air function

Fig.6.12 Turn on Air Function in Fahrenheit

Note:

- ① Air function is only effective for units with air function and fresh air motorized air valve (abbr. fresh air valve).
- ② The following table indicates the opening time of fresh air valve per unit of time (60min) corresponding to the level of Air setting. Opening time of fresh air valve is the initial N minutes per unit of time. Example: The level of Air setting is set to 1, then unit starts timing and fresh air valve is open. 6 minutes later, fresh air valve is closed and unit keeps running. After timing for minutes, unit restarts timing and fresh air valve is open again. 6 minutes later, the valve is closed and the cycle repeats.

Level of Air setting	1	2	3	4	5	6	7	8	9	10
Opening time of fresh air valve	60 /6	60 /12	60 /18	60 /24	60 /30	60 /36	60 /42	60 /48	60 /54	Always on
Note: time indicated in the table: unit's operating time (min) / opening time of fresh air valve per operating time (min)										

## 6.10 LIGHT ON/OFF SETTING

Light On/Off Function: Light of indoor unit can be turned on or off.

Turn on the Light: When unit is on or off, press FUNCTION button to select Light function. “” icon will blink. Press ENTER/CANCEL to turn on the light

Turn off the Light: When light of indoor unit is on, press FUNCTION button to select Light. Then press ENTER/CANCEL to turn off the light.

Note:



When there is no button operation on the wired controller or no remote control signal is received for 20s continuously:

- ① If Light function is activated, the back light of LCD will turn to half bright.
- ② If Light function is off, the back light of LCD will be off.

## 6.11 SAVE SETTING

Save Function: Air conditioner can be operated in small temperature range by setting the minimum temperature under Cooling and Dry modes and setting maximum temperature under Heating, 3D Heating and Space Heating modes. Thus, energy saving can be realized.

Start up Save function for Cooling: When the unit is off, simultaneously press “TIMER” and “▲” buttons for 5s, the buzzer will give out a sound and then unit will enter into Save setting mode. “\$” icon is blinking. “MIN” icon and Mode icon are on. Press “MODE” button to switch to Cooling or Dry mode. Press “▲” or “▼” button to adjust the temperature limit for Save function; press “ENTER/CANCEL” button to start up Save function.

Fig.6.13 or 6.14 Shows how to set Save function for Cooling:

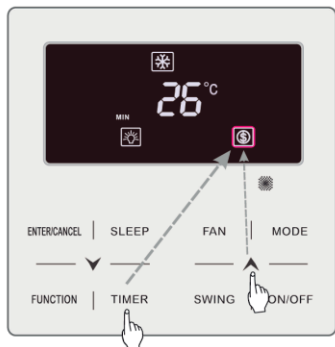

Press TIMER + " ^ " button for 5 seconds and set Save in OFF status



Press MODE button and select Cooling or Dry mode

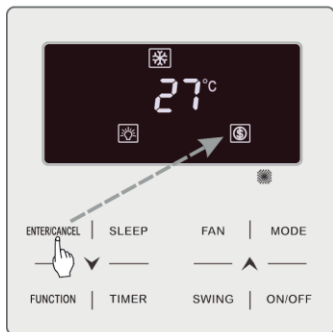

Press ENTER/CANCEL button to activate Save function

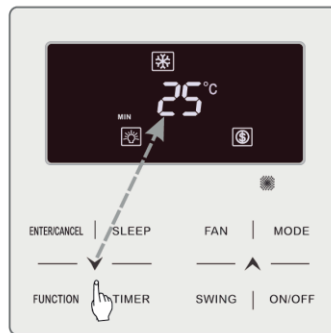

Press " ^ " or " v " button to adjust the minimum temperature

Fig.6.13 Save Setting for Cooling in Celsius

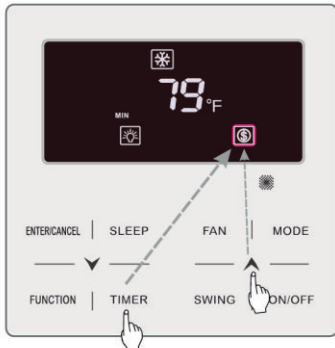

Press TIMER + "▲" button for 5 seconds and set Save in OFF status

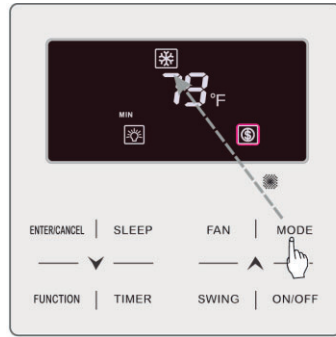

Press MODE button and select Cooling or Dry mode

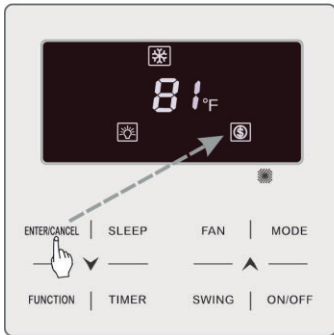

Press ENTER/CANCEL button to activate Save function

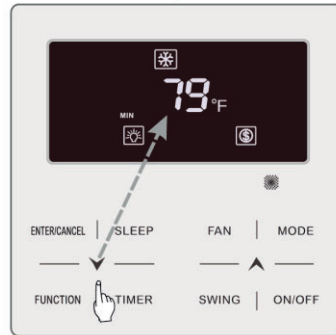

Press "▲" or "▼" button to adjust the minimum temperature

Fig.6.14 Save Setting for Cooling in Fahrenheit

Start up Save function for Heating: When the unit is off, simultaneously press “TIMER” and “▲” buttons for 5s, the buzzer will give out a sound and then unit will enter into Save setting mode. “\$” icon is blinking. “MAX” icon and Mode icon are on. Press “MODE” button to switch to Heating or 3D Heating or Space Heating mode. Press “▲” or “▼” button to adjust the temperature limit for Save function. Press “ENTER/CANCEL” button to start up Save function.

After starting up save function, it will display “\$” icon for all modes under on and off status.

Cancel save function:

When the unit is off, press “TIMER” and “▲” buttons for 5s to enter into save setting, press “ENTER/CANCEL” button to cancel Save function of all modes.

Note: When the Save function is turned on and then set temperature exceeds the limit value for Save function, “\$” icon blinks three times and then buzzer will give out two sounds successively.

## 6.12 FILTER CLEAN REMINDER SETTING

Filter Clean Reminder Function: Unit will remember its own operating time. When the setting time is up, this function will remind you to clean the filter. A dirty filter will result in bad heating and cooling performance, abnormal protection, bacteria gathering, etc.

Turn on Filter Clean Reminder Function: When unit is on, press FUNCTION button and select Filter Clean Reminder. “CLEAN” icon will blink. Press “▲” or “▼” button to adjust the cleaning level, of which the range is 00, 10-39. Press

ENTER/CANCEL to turn on this function

Turn off Filter Clean Reminder Function: When unit is on and this function has been turned on, press FUNCTION button and select Clean. Then “**CLEAN**” icon will blink. Set the cleaning level as 00 and press ENTER/CANCEL function to cancel this setting.

When Filter Clean Reminder time is up, “**CLEAN**” icon will light up to remind you to clean the filter. Press FUNCTION button to turn to Filter Clean Reminder Function, then press SWING/ENTER to cancel reminding, and it will retime according to the original cleaning level. The clean reminding can be cancel only when you didn't reset the cleaning level under the setting of Filter Clean Reminder Function.

Fig.6.15 or 6.16 Shows how to turn on Filter Clean Reminder function:

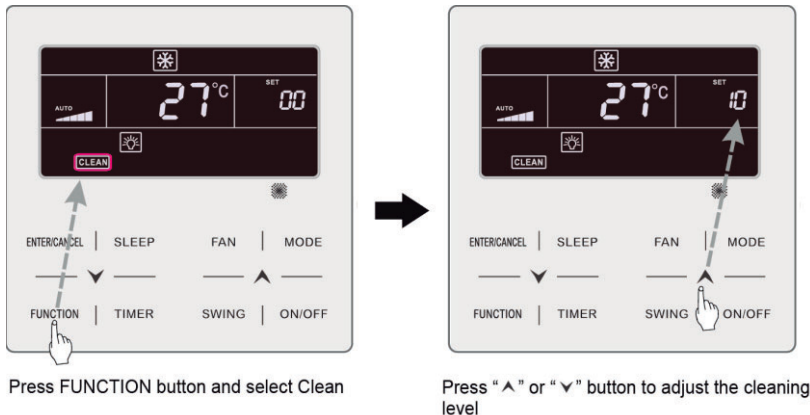



Press ENTER/CANCEL button to activate Clean function

Fig.6.15 Turn on Filter Clean Reminder Function in Celsius

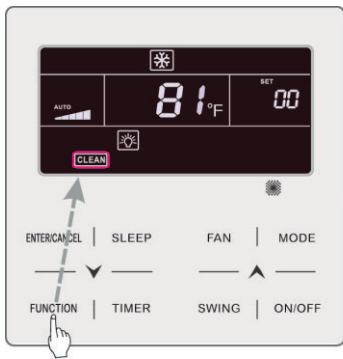

Press FUNCTION button and select Clean

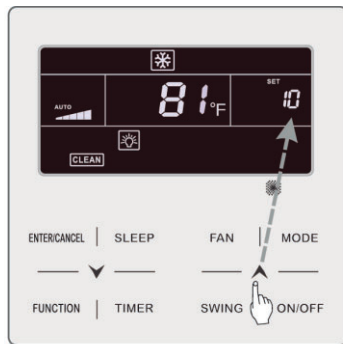

Press "▲" or "▼" button to adjust the cleaning level

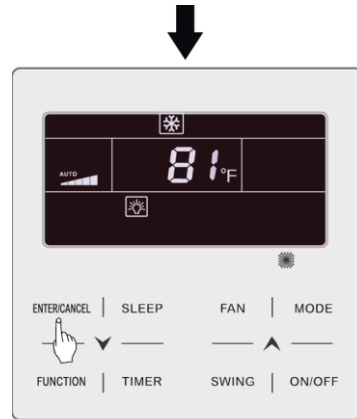

Press ENTER/CANCEL button to activate Clean function

Fig.6.16 Turn on Filter Clean Reminder Function in Fahrenheit

**Note:**

Description on cleaning level: When setting the Filter Clean Reminder Function, timer zone will display 2 digits, of which the former indicates the pollution degree of operating place and the latter indicates the operating time of indoor unit. There are 4 types of situations:

Cleaning Level	Description of Levels
Turn off Clean	Timer zone shows 00
Slight Pollution	The former digit shows 1 while the latter one shows 0, which indicates the accumulating operating time is 5500 hours. Each time the latter digit increases 1, the operating time increases 500 hours. When it reaches 9, it means the operating time is 10000 hours.
Medium Pollution	The former digit shows 2 while the latter one shows 0, which indicates the accumulating operating time is 1400 hours. Each time the latter digit increases 1, the operating time increases 400 hours. When it reaches 9, it means the operating time is 5000 hours.
Heavy Pollution	The former digit shows 3 while the latter one shows 0, which indicates the accumulating operating time is 100 hours. Each time the latter digit increases 1, the operating time increases 100 hours. When it reaches 9, it means the operating time is 1000 hours.

## 6.13 X-FAN SETTING

**X-fan Function:** If unit is turned off under Cooling or Dry mode, the evaporator of indoor unit will be dried off automatically to prevent bacteria and mould from gathering.

**Turn on X-fan:** When unit is on or under Cooling or Dry mode, press FUNCTION button to select X-fan. “**X-FAN**” icon will blink. Then press ENTER/CANCEL button to turn on this function.

**Turn off X-fan:** When X-fan function is on, press FUNCTION button to select X-fan. “**X-FAN**” icon will blink. Then press ENTER/CANCEL button to turn off this function.



---

## 6.14 ABSENCE SETTING

**Absence Function:** This is used to maintain indoor temperature so that unit can realize fast heating after it is turned on. This function can only be used under Heating mode.



**Turn on Absence Function:** Under Heating mode, press FUNCTION button to select Absence.  icon will blink. Then press ENTER/CANCEL button to turn on this function.

**Turn off Absence Function:** When this function is on, press FUNCTION button to select Absence.  icon will blink. Then press ENTER/CANCEL button to turn off this function.

## 6.15 REMOTE SHIELD FUNCTION

**Remote Shield Function:** Remote monitor or central controller can disable the relevant functions of wired controller so as to realize the function of remote control.

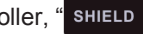
Remote Shield Function includes all shield and partial shield. When All Shield function is on, all controls of the wired controller are disabled. When Partial Shield function is on, those controls that are shielded will be disabled.



When the remote monitor or central controller activates Remote Shield on the wired controller,  icon will show. If user wants to control through the wired controller,  icon will blink to remind that these controls are disabled.

## 6.16 CHILD LOCK FUNCTION

When unit is turned on normally or turned off, pressing “▲” and “▼” button together for 5 seconds will turn on Child Lock function. “” will show on the display. Pressing “▲” and “▼” together again for 5 seconds to turn off this function.

All the other buttons will be disabled when Child Lock function is on.

## 6.17 GATE-CONTROL FUNCTION

When there is Gate-control System, user can insert a card to turn on the unit or pull off a card to turn off the unit. When the card is re-inserted, the unit will recover the operation as state in memory. When the card is pulled off (or improperly inserted), “” icon will show, neither remote control nor operation of wired controller will be effective and icon “” will be flickering.

Note: This model cannot be connected with gate control system on its own because it cannot detect gate control signal directly. To realize gate control display and gate control function, it has to be used with wired controller that includes gate control signal detecting function (used as master and salve wired controller).

## 7 ERROR DISPLAY

When there occurs any error during operation, the temperature display zone on the wired controller will show error codes. If several errors happen at the same time, error codes will show on the display repeatedly.

⚠ Note: If error occurs, please turn off the unit and send for professionals to repair.

Fig.7.1 is the display of Outdoor Unit High Pressure Protection when unit is on.

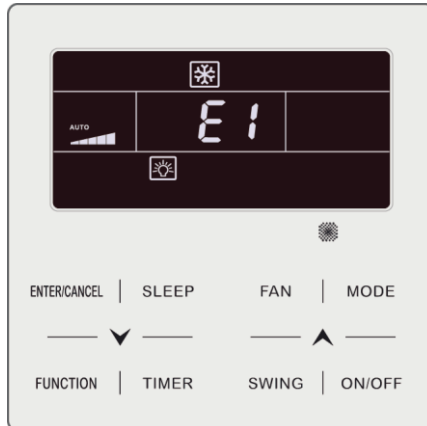

Fig.7.1 Display of Outdoor Unit High Pressure Protection

## 7.1 TABLE OF ERROR CODES FOR OUTDOOR UNIT

Error Code	Content	Error Code	Content	Error Code	Content
E0	Outdoor Unit Error	FL	Compressor 3 Current Sensor Error	b4	Subcooler Liquid-out Temperature Sensor Error
E1	High Pressure Protection	Fn	Mode Exchanger Inlet Pipe Temperature Sensor Error	b5	Subcooler Gas-out Temperature Sensor Error
E2	Discharge Low Temperature Protection	FP	Malfunction of DC motor	b6	Gas-liquid separator inlet temperature sensor error
E3	Low Pressure Protection	FU	Compressor 2 Top Temperature Sensor Error	b7	Gas-liquid separator outlet temperature sensor error
E4	Excess Discharge Temperature Protection of Compressor	J1	Compressor 1 Over-current Protection	b8	Outdoor Humidity Sensor Error
F0	Bad Performance of the Outdoor Mainboard	J2	Compressor 2 Over-current Protection	b9	Heat Exchanger Gas-out Temperature Sensor Error
F1	High Pressure Sensor Error	J3	Compressor 3 Over-current Protection	bA	Oil-return Temperature Sensor Error
F3	Low Pressure Sensor Error	J4	Compressor 4 Over-current Protection	bC	Compressor 1 Top Temperature Sensor Detachment Protection
F5	Compressor 1 Discharge Temperature Sensor	J5	Compressor 5 Over-current Protection	bE	Malfunction of entry tube temperature sensor of

Error Code	Content	Error Code	Content	Error Code	Content
	Error				condenser
F6	Compressor 2 Discharge Temperature Sensor Error	J6	Compressor 6 Over-current Protection	bF	Malfunction of exit tube temperature sensor of condenser
F7	Compressor 3 Discharge Temperature Sensor Error	J7	4-way Valve Blow-by Protection	bH	System Clock Malfunction
F8	Compressor 4 Discharge Temperature Sensor Error	J8	System Pressure Over-Ratio Protection	bJ	High and low pressure sensors are connected inversely
F9	Compressor 5 Discharge Temperature Sensor Error	J9	System Pressure Under-Ratio Protection	bL	Compressor 2 Top Temperature Sensor Detachment Protection
FA	Compressor 6 Discharge Temperature Sensor Error	JA	Protection of Abnormal Pressure	P0	Compressor Drive Board Error
Fb	Compressor 2 Top Temperature Sensor Error	JC	Protection of Water Flow Switch	P1	Compressor Drive Board Malfunction
FC	Compressor 2 Current Sensor Error	JE	Oil return pipe is blocked	P2	Protection of Compressor Drive Board Power Supply
Fd	Mode Exchanger Outlet Pipe Temperature Sensor Error	JF	Oil return pipe is leaking	P3	Protection of Compressor Drive Board Module Reset
FE	Compressor 4 Current Sensor Error	JL	Protection of Low High-pressure	H0	Error of Fan Drive Board

## Wired Controller CDV-46

Error Code	Content	Error Code	Content	Error Code	Content
FF	Compressor 5 Current Sensor Error	b1	Outdoor Ambient Temperature Sensor Error	H1	Malfunction of Fan Drive Board
FH	Compressor 1 Current Sensor Error	b2	Defrosting Temperature Sensor 1 Error	H2	Protection of Fan Drive Board Power Supply
FJ	Compressor 6 Current Sensor Error	b3	Defrosting Temperature Sensor 2 Error		

## 7.2 TABLE OF ERROR CODES FOR INDOOR UNIT

Error Code	Content	Error Code	Content	Error Code	Content
L0	Indoor Unit Error	LF	Shunt Valve Setting Error	d9	Jumper Cap Error
L1	Indoor Fan Protection	LH	Low Air Quality Warning	dA	Indoor Unit Hardware Address Error
L2	E-heater Protection	LJ	Wrong Setting of Function DIP Switch	dB	Special Code: Field Debugging Code
L3	Water Full Protection	LP	Zero-crossing malfunction of PG motor	dC	Capacity DIP Switch Setting Error.
L4	Wired Controller Power Supply Error	LU	Inconsistent Branch of Group-controlled Indoor Units in Heat Recovery System	dE	Indoor Unit CO2 Sensor Error
L5	Anti-Frosting Protection	d1	Indoor Unit PC-Board Error	dH	Wired Controller PC-Board Error
L7	No Master Indoor Unit Error	d3	Ambient Temperature Sensor Error	dL	Outlet Air Temperature Sensor Error

Error Code	Content	Error Code	Content	Error Code	Content
L8	Power Insufficiency Protection	d4	Inlet Pipe Temperature Sensor Error	dn	Swing Assembly Error
L9	Quantity Of Group Control Indoor Units Setting Error	d5	Malfunction of middle tube temperature sensor	y7	Fresh Air Inflow Temperature Sensor Error
LA	Indoor Units Incompatibility Error	d6	Outlet Pipe Temperature Sensor Error	y8	Indoor Air Box Sensor Error
Lb	Inconsistency of Group-controlled Indoor Units in Reheat Dehumidification System	d7	Humidity Sensor Error	y9	Outdoor Air Box Sensor Error
LC	Outdoor-Indoor Incompatibility Error	d8	Water Temperature Abnormality		

## 7.3 TABLE OF DEBUGGING CODES

Error Code	Content	Error Code	Content	Error Code	Content
U2	Outdoor Unit Capacity Code/Jumper Cap Setting Error	UL	Emergency Operation DIP switch setting of the compressor is wrong.	CE	Communication Failure Between Mode Exchanger and Indoor Unit
U3	Phase Sequence Protection of Power Supply	C0	Communication between indoor unit and outdoor unit and the communication between indoor unit and wired controller have malfunction.	CF	Error of Multiple Master Indoor Unit
U4	Protection of Lack of Refrigerant	C2	Communication error between master control and inverter compressor drive	CH	Rated capacity is too high.

## Wired Controller CDV-46

Error Code	Content	Error Code	Content	Error Code	Content
U5	Wrong Address of Compressor Drive Board	C3	Communication error between master control and inverter fan motor drive	CJ	System addresses is incompatible.
U6	Valve Abnormal Alarm	C4	Error of Lack of Indoor Unit	CL	Rated capacity is too low.
U8	Indoor Unit Tube Malfunction	C5	Alarm of Indoor Unit Project Number Collision	Cn	Indoor and Outdoor Network Error of Mode Exchanger
U9	Outdoor Unit Tube Malfunction	C6	Alarm of Wrong Number of Outdoor Unit	CP	Error of Multiple Master Wired Controller
UC	Master indoor unit is successfully set.	C7	Mode Exchanger Communication Error	CU	Communication Error between Indoor Unit and Remote Receiver
UE	Refrigerant Charging is ineffective.	Cb	Outflow of Units IP Address	Cy	Communication Error of No Master in Mode Exchanger
UF	Indoor Unit Identification Error of Mode Exchanger	Cd	Communication Failure Between Mode Exchanger and Outdoor Unit		



## 7.4 TABLE OF STATUS CODES

Error Code	Content	Error Code	Content	Error Code	Content
A0	Unit is waiting for debugging.	A8	Vacuum-pumping Mode	AJ	Filter Clean Reminder
A1	Check the compressor operation parameters.	Ab	Emergency Stop	AU	Remote Urgent Stop
A2	After-sales Refrigerant Reclaim	Ad	Operation Restriction	n3	Compulsory defrosting
A3	Defrosting	AC	Cooling	qE	EVI Operating Mode
A4	Oil return	AF	Fan		
A5	Online Testing	AH	Heating		



dzitsu