

ONESHOW

Stand-alone

Free

Base

ISA S.p.A.

Via Madonna di Campagna 123 - 06083 Bastia Umbra PG - Italy

T. +39 075 801 71 - F. +39 075 800 09 00 - E. customerservice@isaitaly.com

www.isaitaly.com



















1.	NOTES / WARNINGS	4
2.	MANUFACTURER	10
3.	WARRANTY TERMS AND CONDITIONS	10
4.	EQUIPMENT IDENTIFICATION	10
5.	USE	11
5.1	COMPOSITION	11
6.	SAFETY	12
6.1	SAFETY DEVICES PRESENT	12
6.2	FIXED PROTECTIONS	12
6.3	ISOLATING THE ELECTRIC POWER SUPPLY	12
6.4	RESIDUAL RISKS	12
6.5	RISK OF CONTACT WITH LIVE PARTS	12
6.6	FIRE	12
6.7	EXPLOSIVE ATMOSPHERE	13
6.8	SLIPPING	13
6.9	TRIPPING	13
6.10	CIRCUIT FAULTS	13
6.11	WARNING SIGNS (IF ANY)	13
6.12	FALLING OBJECTS	13
6.13	COOLING	13
6.14	FOODSTUFFS SAFETY (PACKAGED PRODUCTS)	13
7.	DISPOSAL OF WASTE MATERIAL	14
8.	INSTALLATION	15
8.1	STORAGE AND UNPACKING	15
8.2	ENVIRONMENTAL CONDITIONS	15
8.3	INSTALLATION	15
8.4	POSITIONING / LEVELLING	16
8.5	ELECTRICAL CONNECTION	16
9.	MAINTENANCE	17
10.	FAULTS - TECHNICAL AFTER-SALES ASSISTANCE	18
10.1	ALARMS LIST (IF PRESENT)	19
11.	TECHNICAL SPECIFICATIONS	20
11.1	GLASS DOOR OPENING EXHIBITION	23
11.2	LIGHTING	23
11.3	GLASS	24
12.	CONTROL PANEL	25
12.1	USER INTERFACE	26
13.	CLEANING	32
13.1	INTERNAL	32
13.2	CONDENSING UNIT	33
13.3	DEFROST WATER COLLECTION TRAY (IF PRESENT)	34
13.4	POLICARBONATE CONTAINERS	34
14.	PROLONGED APPLIANCE SWITCH-OFF	34

ATTACHMENTS

1 WIRING DIAGRAM - 412100804000

35

The manual contains symbols to attract the reader's attention and highlight particularly important aspects. The table below illustrates the meaning of the various symbols used.

	Read the manual		Use of protective clothing
	DANGER Live electrical parts		Requests for maintenance or operations must be carried out by qualified staff or technical after-sales centres
	ATTENTION / DANGER		Important information
	Information		Operations that must be performed by two persons
	Visual check		NOTES / WARNINGS
	On-board Condensing unit		Remote Condensing unit
	DANGER Slipping		Waste disposal
	DANGER Tripping		Recyclable materials
	Earthing		

1. NOTES / WARNINGS



NOTE

The content of this manual is of technical nature and is owned by **ISA**. It is forbidden to reproduce, circulate or modify all or part of its content without written consent. Any infringement will be legally pursued.

The manual and the conformity certificate are an integral part of the equipment and should always accompany the product in the event of a transfer to a new location or to a new owner. The user is responsible for the integrity of these documents, for their consultation and during the whole life cycle of the equipment itself. Keep this manual in a safe place. It should be available for consultation near the equipment at all times. If lost or destroyed, you can request a copy of the manual from **ISA** by specifying the exact model, serial number and year of manufacture. The manual reflects the manufacturing technology at the time of supply. The manufacturer reserves the right to modify its products in any way it deems necessary, with no obligation to update manuals and machines relating to previous manufacturing batches.

The equipment can be used by children no younger than 8 and by persons with reduced physical, sensorial or mental capabilities, or lacking experience or necessary knowledge, as long as supervised or after having received training regarding safe use of the equipment and have an understanding of the inherent risks involved. Do not allow children to play with the device. The cleaning and maintenance that the user will carry out must not be undertaken by children without supervision.

Always refer to this manual before going ahead with any operation. Before doing any type of work, disconnect the equipment from the power supply. Any work on electric and electronic parts or cooling system components should only be carried out by trained personnel in compliance with current laws.

The Manufacturer cannot be held liable for any damage to persons, animals or to the product in the cases below:

- Improper use of the equipment or use of the appliance by unqualified or unauthorised personnel.
- Failure to comply with current legislation.
- Incorrect installation and/or power supply faults.
- Failure to observe the instructions contained in this manual.
- Failure to follow the maintenance programme.
- Unauthorised modifications.
- Installation of non-original spare parts in the equipment.
- Installation and use of the equipment for purposes other than those for which the appliance was designed and sold;
- Tampering with or damage to the power supply cable.

1. NOTES / WARNINGS

Liability for applying the safety instructions contained in this manual is held by the technical personnel responsible for the intended use of the equipment, who should ensure that authorised personnel:

- Are qualified to carry out the requested activity;
- Is aware of and carefully complies with the instructions contained in this document
- Are aware of, and apply, the general safety standards applicable to the equipment.

The buyer is responsible for training personnel using the appliance on the risks, safety devices and general health and safety rules required by the laws of the country where the appliance is installed. Users/operators should be aware of the position of all the controls and how they work, as well as of the features of the appliance.

They should also read this manual in its entirety. Maintenance work should be conducted by qualified personnel after the appliance has been prepared adequately..

DANGER



Unauthorised tampering or replacement of one or more parts of the appliance, use of accessories that modify the use of the same and use of spare parts different to those recommended, can become the cause of injury.

DANGER



Any work conducted on the on the appliance **must** involve disconnection from the power socket and in any case, none of the protective elements (grid, casing) should be removed by non-qualified staff. The appliance should not be operated when these protective elements have been removed.

NOTE



In order not to compromise functionality and safety of the appliance, the particularly complex installation and maintenance activities are not documented in this manual and are performed by specialised **ISA** technicians.

Never use electric devices inside this appliance. Do not use mechanical or other means to accelerate the defrosting process, other than recommended by the manufacturer. Keep the air vents in the casing of the appliance or in the structure built into the wall free of obstructions. Do not damage the refrigerant circuit.

RISK OF EXPLOSION

Do not store in the equipment products which contain flammable propellants and explosives.

1. NOTES / WARNINGS

STAFF TRAINING

The buyer is responsible for ensuring personnel who will use the appliance and maintenance technical staff are instructed and trained adequately. The manufacturer is available for advice, clarifications, etc. so that the operator and technical staff can use the appliance correctly.

To ensure the operator's safety, appliance devices should be kept in constant working order. This manual is intended to illustrate the use and maintenance of the appliance. The operator has a responsibility and duty to carefully observe the instructions contained within it.

Failure to comply with safety standards may result in injury to personnel and damage to the equipment components and control unit. The user can contact the dealer to request additional information not contained in this document, or suggest improvements, at any time.



Before the product is delivered to the customer, it is essential that a **trained technical member of staff** checks that the appliance is operating correctly in order to achieve maximum performance.

INTRODUCTION

ISA employs materials of the best quality and as they enter the company, we constantly monitor their storage and the use as part of the manufacturing process to prevent damage, deterioration and failure. All manufacturing elements are designed and manufactured in order to guarantee reliability and high safety standards. All appliances are subjected to a strict testing procedure before delivery. However, please bear in mind that product performance over time depends on correct use and adequate maintenance. This manual contains the necessary instructions to maintain the appliance's initial appearance and functions over time.

The Use and Maintenance manual contains the necessary information for understanding how the appliance works and how to use it properly, namely: the technical description of the various operational units, equipment and safety systems, operations, how to use the instruments and the interpretation of any diagnostics reports, main procedures and information relating to routine maintenance. For correct use of the appliance, the working environment should comply with current health and safety standards.

The safety requirements, indications, standards and notes illustrated in the various chapters of the manual are aimed at establishing a code of conduct and a series of obligations to be observed when performing the various activities, in order to create safe conditions for personnel, the equipment and the surrounding environment.

1. NOTES / WARNINGS

The safety standards reported in this document are intended for trained, authorised personnel responsible for:

- Transport
- Installation
- Operation
- Management
- Maintenance
- Cleaning
- Putting out of order
- Disposal

ATTENTION



Reading this manual, albeit in full, is no substitute for adequate user experience. therefore it should only be considered a useful reminder of the technical features and the main operations to perform.

NOTE



The installers and users must read and understand the instructions contained herein before any operation on the appliance.



1. NOTES / WARNINGS

R744 - REFRIGERANT (WHERE APPLICABLE)

R744 The refrigerant **R744** is a gas that is compatible with the environment. Pay close attention during transport, installation and that the destruction not to damage the refrigerant pipelines.

IN THE EVENT OF DAMAGE:

Keep away from the flame or ignition sources. Properly ventilate the premises for a few minutes. Turn the unit off, pull the plug. Inform customer support service.



WARNING

The refrigerant system is **High Pressure**.



Do not tamper with the system, but call a specialised and qualified technician before disassembly.



ATTENTION

Maintenance must be performed exclusively by qualified staff.

R290 - REFRIGERANT (WHERE APPLICABLE)



The refrigerant **R290** is a gas that is compatible with the environment, but **highly flammable**.

Pay close attention during transport, installation and that the destruction not to damage the refrigerant pipelines.

IN THE EVENT OF DAMAGE:

Keep flames or sources of ignition away from the appliance. Properly ventilate the premises for a few minutes. Turn the unit off, pull the plug. Inform customer support service. The more refrigerant containing an appliance, the greater must be the environment in which there is the unit. In areas too small, in the event of leakage can form a flammable mixture of air and gas. **The volume of the room where the appliance is installed must be at least 19 m³ for each cooling system present in the room.**



ATTENTION

Maintenance must be performed by qualified personnel that has been to work with flammable refrigerants.

1. NOTES / WARNINGS

R600a - REFRIGERANT (WHERE APPLICABLE)



The refrigerant **R600a** is a gas that is compatible with the environment, but **highly flammable**.

Pay close attention during transport, installation and that the destruction not to damage the refrigerant pipelines.

IN THE EVENT OF DAMAGE:

Keep flames or sources of ignition away from the appliance. Properly ventilate the premises for a few minutes. Turn the unit off, pull the plug. Inform customer support service. The more refrigerant containing an appliance, the greater must be the environment in which there is the unit. In areas too small, in the event of leakage can form a flammable mixture of air and gas. **The volume of the room where the appliance is installed must be at least 17 m³ for each cooling system present in the room.**



ATTENTION

Maintenance must be performed by qualified personnel that has been to work with flammable refrigerants.

2. MANUFACTURER

ISA
S.p.A.

Via Madonna di Campagna 123
06083 - Bastia Umbra
Perugia - Italy

Tel. +39 075 80171
Fax +39 075 8000900
E. customerservice@isaitaly.com

www.isaitaly.com

3. WARRANTY TERMS AND CONDITIONS

The seller's warranty on the equipment is valid for **12 (TWELVE) months from the date of delivery**. The warranty includes repairs or replacements of any faulty parts due to manufacturing processes or installation after written communication has been received, stating the appliance serial number and date of installation. Not included in the warranty:

- All defects caused by incorrect use of the appliance.
- All defects caused by incorrect electrical connection.
- All defects caused by normal wear (for instance compressor failure and fluorescent lamp malfunctioning that is not due to manufacturing defects).
- Calls for installation, technical instructions, adjustments and cleaning the condenser.

If the seller's technical staff detect any tampering, unauthorised repairs or inappropriate use of appliance the warranty will be invalidated.

Shipment of components covered by the warranty is freight collect only.

Any damage to the appliance detected at the time of delivery due to transport must be reported on the same shipping note to claim compensation from the carrier.

The seller cannot be held liable in the event of damage to the preserved product due to appliance failure.

4. EQUIPMENT IDENTIFICATION

- Find the label affixed on the machine to read the technical data.
- Check the machine model and the power supply voltage before you perform any operation.
- If you uncover mismatches, contact the manufacturer or the company that supplied the machine immediately.

1		2			
Tip. 3		Mod. 4			
Art. 5					
Data prod. - Prod. Date 6	Ordine prod. - Prod. Order 7	Ord. cliente - Cust. Order 8	Classe Prodotto - Product Class (En23953) 9		
Matricola - Serial Number 10		Matr. di Proprietà - Property Number 11			
12 V~	13 Hz	14 A	15 W	16 W	
Potenza nominale - Rated Power 17 W	Potenza in Sbrinam. - Defrosting Power 18 W	Psig min 19	Psig max 20	Classe Sicur. - Safety Class (EN 60335-2-89) 21	
Corrente nominale - Rated Current 22 A	Corrente in Sbrinam. - Defrosting Current 23 A	Carico rip. - Shelf load 24 Kg/m2	Carico vasca - Tank load 25 Kg/m2		
Tipo Refrigerante Refrigerant Type 1, 2, 3 26		Peso Refrigerante Refrigerant Weight 27 Kg		Volume Lordo - Gross Volume 28 L	
		Espandente - Foaming Agent 29		30	
CONTIENE GAS FLUORURATI AD EFFETTO SERRA DISCIPLINATI DAL PROTOCOLLO DI KYOTO; SISTEMA ERMETICAMENTE SIGILLATO CONTAINS FLUORINATED GREENHOUSE GASES COVERED BY THE KYOTO PROTOCOL; SYSTEM HERMETICALLY SEALED					

1	IDENTIFICATION OF THE COMPANY PRODUCT MANAGER
2	SYMBOLS OF COMPLIANCE
3	TYPE
4	MODEL NAME
5	ARTICLE
6	PRODUCTION DATE
7	PRODUCTION ORDER
8	CUSTOMER ORDER
9	PRODUCT CLASS
10	SERIAL NUMBER
11	OWNER REGISTRATION NUMBER
12	VOLTAGE
13	SUPPLY VOLTAGE
14	FUSE VALUE
15	LAMP POWER
16	ELECTRICAL RESISTANCE ABSORPTION
17	NOMINAL POWER (NORMAL OPERATION)
18	POWER (DEFROSTING)
19	MINIMUM PRESSURE
20	MAXIMUM PRESSURE
21	SAFETY CLASS
22	NOMINAL CURRENT
23	CURRENT DURING DEFROSTING
24	LEVEL LOAD
25	TANK LOAD
26	TYPE OF COOLANT
27	WEIGHT OF COOLANT
28	GROSS VOLUME
29	EXPANDING ISOLATION AGENT
30	WEEE MARK

5. USE

This appliance is exclusively intended to:

DISPLAY AND SELL GELATO & PASTRY

The manufacturer is not liable for injury to persons or damage to property or the appliance itself caused by the displaying of products other than those described above.

THE APPLIANCE IS INTENDED FOR PROFESSIONAL USE



Uses not allowed

- Food preservation.
- Displaying and/or preserving non-food products (chemicals, pharmaceuticals, etc...).

ATTENTION



LOAD LIMITS



It is fundamental **not to exceed** the load limits **indicated** in order to avoid altering the correct circulation of air and to avoid the temperature of the product being too high. The limits indicated refer to a static and evenly distributed load. Therefore dynamic overloads due to violent loading operations are excluded, which must be prevented for safety reasons.

5.1 COMPOSITION

The appliance is made up from a unique cabinet, onto which all devices necessary to make it a professional and efficient product for its declared use, are installed.

The appliance is made up from:

Cooling system at Ventilated Refrigeration

Condenser unit on board

Electrical system

Electronic controller

Insulated monolithic structure in ecological polyurethane

Height-adjustable feet for stabilisation of the floor

Lighting LED

Lids glass closure opened by hand

Pivoting wheels with locking brake

OPTIONAL



6. SAFETY

The appliance is equipped with safety devices. The buyer is responsible for training personnel using the appliance on the risks, safety devices and general health and safety rules required by the laws of the country where the appliance is installed. Users/operators should be aware of the position of all the controls and how they work, as well as of the features of the appliance. They must also have read this manual in its entirety.

6.1 SAFETY DEVICES PRESENT

Devices whose operation prevents the occurrence of risk situations in operating conditions (e.g. fuses, pressure switches, protections, magnet circuit breakers, etc.).

6.2 FIXED PROTECTIONS

Fixed protective devices consist of fixed perimeter shields, which are used to prevent external parts from entering the equipment.



DANGER

It is prohibited to re-start the appliance following maintenance without having correctly restores the panels.



VISUAL CHECK

You should check the integrity of fixed panels and corresponding fixings to the frame, focussing in particular on the protective panels.

6.3 ISOLATING THE ELECTRIC POWER SUPPLY

Before conducting any maintenance work on the equipment or part of it, it is necessary to section the power supply that powers it.



DANGER

In the event of maintenance operations in which the operator cannot prevent accidental closure of the circuit by others, to totally disconnect the appliance from the mains electricity.

6.4 RESIDUAL RISKS

During design the manufacturer examined all the areas or parts at risk. Therefore, all necessary precautions have been taken to prevent risks to persons and damage to the appliance.



ATTENTION

- Periodically check that all safety devices are operating correctly.
- Do not remove the fixed guards.
- Do not introduce objects or tools into the work area.

Although the appliance is fitted with the safety devices prepared, there are still some risks that cannot be eliminated, but reduced via corrective actions by the final integrator and correct operational procedures. Below is a summary of the remaining risks associated with the appliance during:

- Normal operation.
- Adjustement and tweaking.
- Maintenance.
- Cleaning.

6.5 RISKS OF CONTACT WITH LIVE PARTS

Risk of breaking or damaging the electrical components of the appliance, with a possible reduction in safety levels, following a short circuit.

Before connecting the electricity supply, make sure there is no ongoing maintenance work.



ATTENTION

Before making the connection, check that the d.c. current in the installation point does not exceed that indicated on the protections switches present in the electric control board. If this is not the case, the user must envision the relevant limiting devices. It is strictly forbidden to conduct any electrical modification, in order to prevent additional unforeseen hazards and risks.

6.6 FIRE



DANGER

In the event of a fire, immediately disconnect the master switch from the main power supply line.

6.7 EXPLOSIVE ATMOSPHERE

The equipment must not be located in an area classified as an explosion risk according to 1999/92/EC such as:

Zone 0

An area in which there is a permanent, long-lasting or frequently explosive atmosphere made up of a mixture of air and flammable substances in the form of gases, fumes or steam.

Zone 1

An area in which the formation of an explosive atmosphere, made up of a mixture of air and flammable substances in the form of gases, fumes or steam is occasionally probable during normal activities.

Zone 20

An area in which there is a permanent, long-lasting or frequently explosive atmosphere in the form of clouds of combustible dust in the air.

Zone 21

An area in which the formation of an explosive atmosphere in the form of clouds of combustible dust is occasionally probable during normal activities.

6.8 SLIPPING



DANGER

Any leaks in the areas surrounding the appliance may cause personnel to slip. Check that there are no leaks and keep these areas clean at all times.

6.9 TRIPPING



DANGER

Generally untidy deposits of material may constitute a tripping hazard and a total or partial obstruction of emergency exit routes. You should ensure that operating and transit areas and escape routes are free from obstacles in compliance with current law.

6.10 CIRCUIT FAULTS

Owing to potential faults, safety circuits may become less effective, which results in lower safety levels. You should check the operational condition of the appliance devices regularly.

6.11 WARNING SIGNS (IF ANY)

The appliance is fitted with warning danger, warning and obligation signs defined in agreement with the Standard relative to the graphical signs to be used on plants. The signs are located in clearly visible positions.



ATTENTION

The warning plates present on the appliance must not be removed.
The user is responsible for replacing warning signs that, owing to wear, become unreadable.

6.12 FALLING OBJECTS

Positioning of the cabinet display parts (i.e. counters, rods and hooks), as also product arrangement inside the cabinet can be the source of potential hazards if not properly performed. Follow the positioning instructions described in this Manual before you place products inside the cabinet, check that the counters are properly fastened, as also the hooks, etc. Do not exceed the maximum load limit. Do not exceed the maximum load limit. Do not position tilted product on the counters if they are not held in place by their stoppers.

6.13 COOLING

During different operations to perform on the counter, such as cleaning or loading goods, it is necessary to handle products and/or counter parts at a low temperature with the risk of "cold injury" for the operators and/or accidental slipping hazard. Follow the safety regulations in the place where the cabinet is installed; more specifically, be sure to always use the right PPE (especially gloves).

6.14 FOODSTUFFS SAFETY (PACKAGED PRODUCTS)

The refrigerator cabinet described herein is meant to be used to display packaged products. As such, it is not designed for direct contact between the foodstuffs and display surfaces. If the foodstuffs do accidentally make contact with the surfaces and for a rather long time, the product may be contaminated. Follow the guidelines on how to use the cabinet. If a product package breaks, remove it from the cabinet and clean, if necessary.

7. DISPOSAL OF WASTE MATERIAL

During normal operation, the appliance does not generate any environmental contamination. At the end of its life cycle, or if it is necessary to proceed to permanent decommissioning, we recommend following the procedures below:

DISPOSAL (USER)



The symbol, applied to either the product or its packaging, indicates that the product should not be considered as normal domestic waste, but should be taken to a waste collection point for the recycling of electrical and electronic appliances. The correct disposal of this product contributes to preventing potential negative consequences that might derive from an inadequate disposal of the product. For detailed information about recycling this product, contact your council, your local waste collection service or the store where you purchased the product.

PROCEDURE FOR DISPOSAL and RECYCLING AT THE END OF APPLIANCE LIFE SPAN (AUTHORISED BODIES)

- Switch off the equipment and unplug the power supply cable.
- Remove the lamps (if installed). These should be disposed of separately.
- Remove the power units and the electronic cards. These should be disposed of separately.
- Remove all the independent parts (grids, casings, profiles, etc.) and group them according to shared features in order to access the heat exchangers, pipes, cables, etc. and be careful not to damage the cooling circuit.
- Remove all mobile parts (doors, sliding doors, glass parts, etc.) and group the various materials according to their features.
- Check the type of refrigerant on the plate positioned inside the counter; extract the refrigerant and dispose of it through authorised services.
- Disconnect the evaporator, condenser, compressor, pipes and fans. These are made of copper, aluminium, steel and plastic and should therefore be disposed of separately.
- On removal of all guards and the various components from the frame, separate the different types of material making up the appliance (plastic, sheet steel, polyurethane, copper, etc) and collect them separately.



All recyclable materials and waste should be processed and recycled by professionals, in compliance with the laws in the country in question. The company responsible for recycling the materials should be registered and certified as a waste disposal service in accordance with the country in question.



ATTENTION

Illegal disposal of the product by the owner will result in administrative sanctions as required by current laws. Disposal of the product should comply with current laws on the disposal of coolant liquids and mineral oils.



IMPORTANT

If the crossed wheeled bin sign is not present on the appliance, it means that the disposal of the product is not the manufacturer's responsibility. In this case, the Regulations regarding the disposal of waste in force are valid.



ADDITIONAL INFORMATION

Further information on the disposal of liquid coolant, oils and other substances is available on the safety data sheet corresponding to the substance itself. In order to dispose of foamed assemblies, remember that the polyurethane foams used are CFC, HFC and HCFC free.

8. INSTALLATION

This manual supplies the information necessary for correct unpacking, procedures for positioning and connection to mains electricity.

8.1 STORAGE AND UNPACKING

The appliance, with or without the packaging, should be carefully stored inside warehouses or in areas away from the elements and direct sunlight, at a temperature between **0** and **+40 °C**.

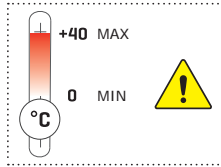

The movement of the apparatus should only be carried out using a fork lift of a suitable power for the weight of the same and manoeuvred by qualified personnel: during such operations the equipment must be positioned on the supplied pallet.

Unplug the appliance from removing the screws that lock the pallet.

All packaging materials are recyclable and should be disposed of in accordance with local regulations. Please destroy "plastic" bags to prevent them from becoming hazardous to children (suffocation).

8.2 ENVIRONMENTAL CONDITIONS

ATTENTION

A dry room that can be ventilated is the suitable location for the appliance's installation. There should be a good air flow around the compressor/condensing unit. Therefore the area around the unit should not be obstructed by boxes or other objects.



Place the equipment away from sources of heat (radiators, heaters of any kind, etc.) and far from the influence of continuous air movement (caused by fans, air conditioning units, etc.). If it is unavoidable to install near a heat source, use a suitable insulating plate. Also avoid exposure to direct sunlight; all of this causes the temperature inside the refrigerated compartment to rise with negative consequences on operation and energy consumption. Do not use the appliance outdoors and do not leave it exposed to rain.

8.3 INSTALLATION

ATTENTION



It is fundamental to respect the distances indicated (mm) for correct installation of the appliance.

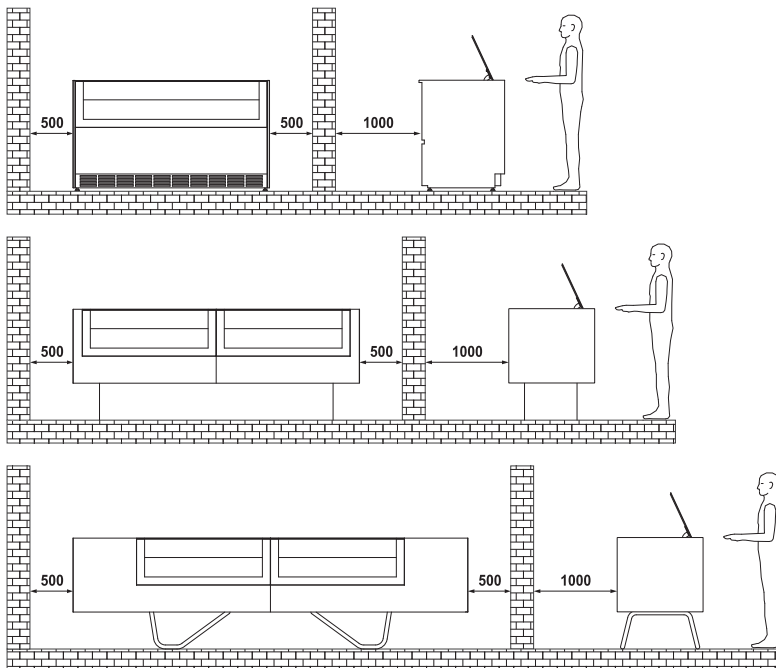

8.4 POSITIONING / LEVELLING



ATTENTION

HEIGHT-ADJUSTABLE FEET

The appliance is set-up with height-adjustable feet for stabilisation of the floor. After positioning it is **absolutely necessary** to level the appliance to the ground.

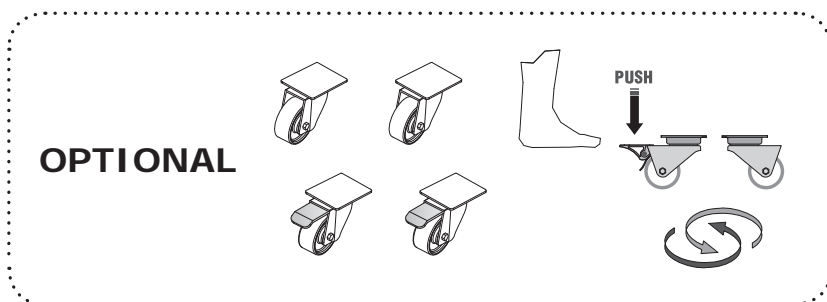
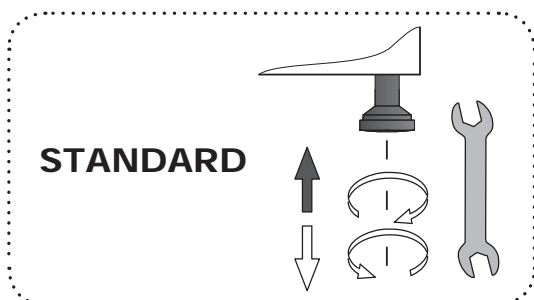

8.5 ELECTRIC CONNECTION



ATTENTION

Check that the network voltage matches the one displayed on the identification plate of the appliance, and that the power is adequate. Check on the socket that the power supply voltage provides rated voltage ($\pm 10\%$) when you start up the compressor. The plug should be directly connected to the electrical socket. It is forbidden to connect the plug to the socket by means of multiple socket extensions or adaptors. the plant power supply socket must be fitted with a disconnection device from the mains electricity (dimensioned to the load and in compliance with Standards in force), which guarantees complete disconnection in category III (3) over-voltage conditions and therefore protects the circuits against earth faults, overloads and short circuits. Do not route the electricity cable in passageways.



ATTENTION

Earthing is necessary and mandatory by law.

9. MAINTENANCE

The **Staff in charge of the appliance** must control and respect the expiry dates for maintenance, given in the table below, calling the authorised **Technical After-sales assistance** when indicated.

OPERATION	FREQUENCY				ORDINARY	EXTRAORDINARY	PERSONNEL AUTHORISED
	Depending on the Use and Necessity	Monthly	six-month	Annual			
CLEANING THE EXTERNAL SURFACES	X				X		USER
CLEANING THE ACCESSIBLE INTERNAL PARTS (without the use of tools)	X				X		
CONTROL POWER SUPPLY CABLE, PLUGS AND / OR ELECTRICAL SOCKETS			X		X		
INTEGRITY CONTROL SEAL		X			X		
FILTER CLEANING CONDENSING UNIT (whenever present)			X		X		
CLEANING THE DEFROSTING WATER COLLECTION TRAY	X				X		TECHNICAL ASSISTANCE 
CONDENSER CLEANING	X			X	X		
CHECK COMPRESSORE OIL LEVEL (whenever present)					X		
AIR TANK DRAINING (whenever present)			X		X		
CONTROL PNEUMATIC CONNECTIONS (whenever present)			X		X		
INTEGRITY CONTROL PIPE COOLING SYSTEM			X		X		
INSPECTION OF CABLES INTERNAL CONNECTIONS AND POWER			X		X		
CLEANING CONDENSATE DRYING SPONGES (whenever present)			X		X		
LAMP / LED REPLACEMENT (whenever present)						X	
CONTROL PANEL REPLACING (electronic control unit - thermostat - etc)						X	
REPLACEMENT POWER SUPPLY CABLE, PLUGS AND / OR ELECTRICAL SOCKETS						X	



ATTENTION



After all maintenance it is **mandatory** to perform all electric safety tests in agreement with the IEC EN 50106 Standard.

10. FAULTS - TECHNICAL AFTER-SALES ASSISTANCE



If the appliance is not working properly or stops working, **before contacting** the Customer support centre, check the following:

THE EQUIPMENT DOES NOT WORK		
CAUSE	SOLUTION	PERSONNEL AUTHORISED
Blown protective fuse	Find the cause of the intervention of the switch first, and then replace the new fuse.	USER
The master switch is open	Close the master switch.	
The plug is not inserted	Insert the plug.	
Electrical black-out	If the black-out should be prolonged, transfer the product into an appropriate cold storage container.	
THE INTERNAL TEMPERATURE IS NOT LOW ENOUGH		
CAUSE	SOLUTION	PERSONNEL AUTHORISED
Evaporator/s obstructed completely by ice	Carry out an additional defrosting cycle.	USER
Wrong temperature setting	Set the appropriate temperature.	
The appliance is affected by draughts or is exposed to direct or reflected sunlight	Remove any draughts and prevent any direct or reflected sunlight.	
Insufficient air flow for cooling to the condenser	Remove anything that may affect air flow inside the condensing unit (paper sheets, cardboard, grids with an insufficient number of holes, etc.).	
Internal fans at standstill or with fans damage		TECHNICAL ASSISTANCE 
Internal ventilation is too high		
Thermostat / Electrical base unit not efficient	Replace the electronic control board. If the control unit is set up especially for must R290 refrigerant, it must only be replaced with an original replacement from ISA. Replace the temperature probes only after checking which of the two is not operating efficiently.	
Condenser unit blocked by dust or dirt in general.	Clean the condensing unit thoroughly. The air condenser or MAINTENANCE FREE, in particular heavy environments (e.g. presence of dust, the presence of excessive moisture, oiled vapours etc..) in order to avoid performance loss, needs accurate cleaning.	
Insufficient refrigerant load in the cooling system	Find the cause behind the lower amounts of coolant and eliminate it. Top up the coolant. If necessary, empty the system before topping up.	
THE COMPRESSOR DOES NOT START-UP OR OPERATES FOR A FEW MOMENTS		
CAUSE	SOLUTION	PERSONNEL AUTHORISED
No electric power supply to the appliance	Check if there is a power cut. Close the various switches on the power supply line.	USER
Excessively low power voltage	Check that the network voltage of the power supply cable is 220V +/- 10%.	
Temperature set too high	If the temperature is higher than the air temperature in the display chamber, the compressor will not start. Set the suited temperature if the current temperature is not low enough.	
Intervention of the maximum pressure switch (where present)	Check the cause of continuous intervention of the maximum pressure switch, which may be: air condenser blocked, condensing fan stopped, ambient temperature too high, pressure switch defective.	TECHNICAL ASSISTANCE 

10.1 ALARMS LIST (IF PRESENT)

ALARMS			
ALARM	DESCRIPTION	OUTPUTS	PERSONNEL AUTHORISED
P1 EO	Broken thermostat probe. Compressor output according to "CO _n " and "COF parameters	<ul style="list-style-type: none"> The alarm starts a few seconds after the probe breaks down; it stops a few seconds after the probe starts working again properly. We recommend checking the probe connections before replacing it. 	TECHNICAL ASSISTANCE 
P2 E1	Broken evaporator probe. Set time for defrosting.	<ul style="list-style-type: none"> The alarm starts a few seconds after the probe breaks down; it stops a few seconds after the probe starts working again properly. We recommend checking the probe connections before replacing it. 	
HA HI	High temperature alarm.	<ul style="list-style-type: none"> The alarm stops automatically on reaching the temperature set. Check programming. 	
LA LO	Low temperature alarm.	<ul style="list-style-type: none"> The alarm stops automatically on reaching the temperature set. Check programming. 	
EA IA CB	External alarm.	<ul style="list-style-type: none"> The external alarm stops after the digital infeed is deactivated, it is restored automatically. The alarm is linked to the intervention of the pressure switch and/or the compressor circuit breaker, when present. 	
ETc RTF	Real time clock is broken.	<ul style="list-style-type: none"> Reset the clock. If the alarm does not stop, replace the clock. 	
EE	Machine parameter error.	<ul style="list-style-type: none"> The instrument is damaged. It must be replaced. 	
EF	Operating parameters error.	<ul style="list-style-type: none"> The instrument is damaged. It must be replaced. 	

11. TECHNICAL SPECIFICATIONS

Modello GELATO Modello CARAPINE	Vaschette Gelato		Vassoio monoporzioni	Carapine
				
	5 Lt 360 x 165 x 120h	5 Lt 360 x 250 x 80h	360 x 250 x 80h	3 Lt Dia. 154 x 160h

Built-In	Gelato Carapine	Regular	6	4	4	10
		Large	9	6	6	16
Free	Gelato Carapine	Regular	6	4	4	10
		Large	9	6	6	16
Stand-alone	Gelato Carapine	-	6+6	4+4	4+4	10+10
Base	Gelato Carapine	Regular	6+6	4+4	4+4	10+10
		Large	9+9	6+6	6+6	16+16

			6	9
External dimensions	Lenght	mm	1200	1705
	Depth	mm	740	
	Height	mm	960	
Weight (net)		Kg	210	280

11. TECHNICAL SPECIFICATIONS

Free - Regular / Large

Gelato

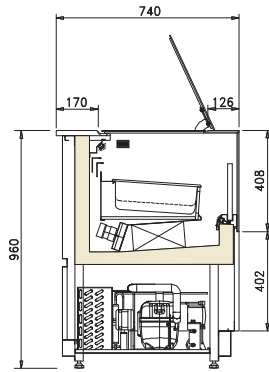

Carapine

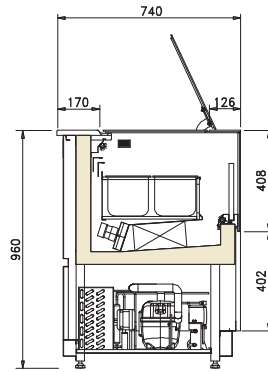

		Regular	Large
Lunghezza	mm	1200	1705
Profondità	mm	740	
Altezza	mm	960	
Peso (netto)	Kg	210	280

Base - Regular / Large

Gelato

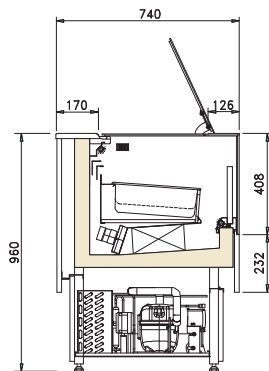

Carapine

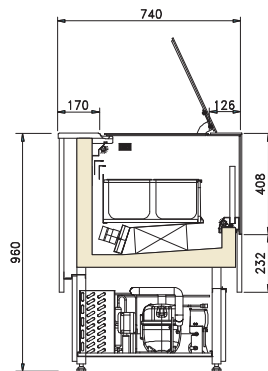

		Regular	Large
Lunghezza	mm	2360	3370
Profondità	mm	740	
Altezza	mm	960	
Peso (netto)	Kg	380	510

Stand-alone

Gelato

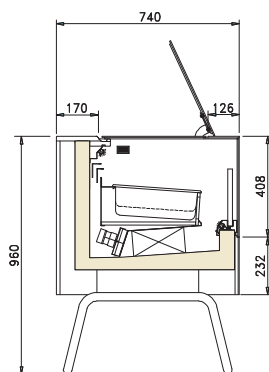

Carapine

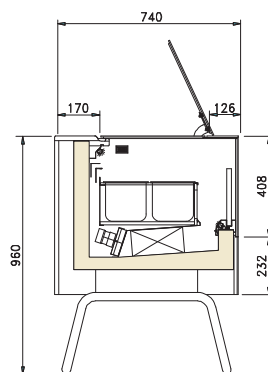

Lunghezza	mm	3420
Profondità	mm	740
Altezza	mm	960
Peso (netto)	Kg	410

11. TECHNICAL SPECIFICATIONS

Free - Regular / Large

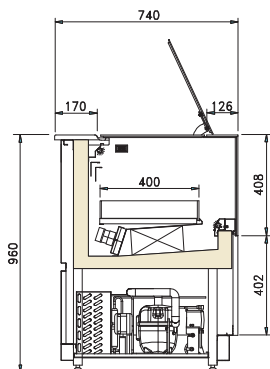

		Regular	Large
Lunghezza	mm	1200	1705
Profondità	mm	740	
Altezza	mm	960	
Peso (netto)	Kg	210	280

Base - Regular / Large

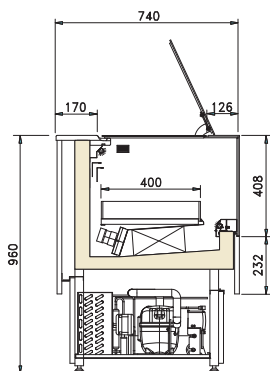

		Regular	Large
Lunghezza	mm	2360	3370
Profondità	mm	740	
Altezza	mm	960	
Peso (netto)	Kg	380	510

Stand-alone

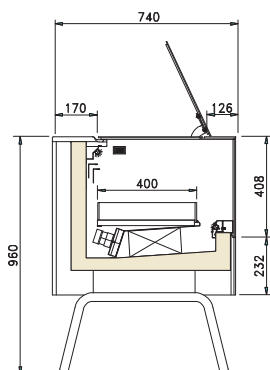

Lunghezza	mm	3420
Profondità	mm	740
Altezza	mm	960
Peso (netto)	Kg	410

11.1 GLASS DOOR OPENING EXHIBITION

Open the glass manually as shown.

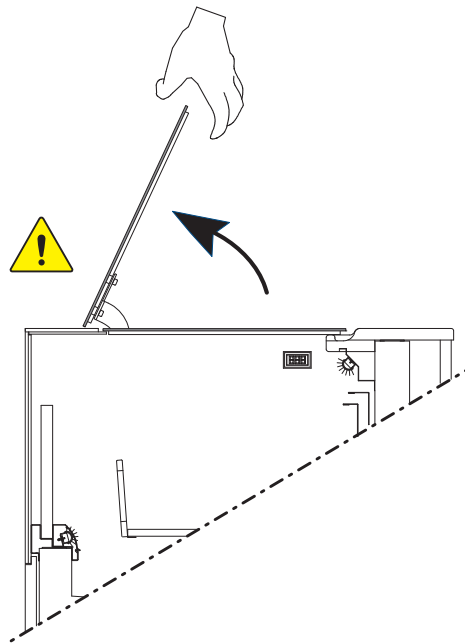

ATTENTION

Raising the glass, while opening, evenly without force.
The glass has a limited opening; **do not force absolutely over the allowed limit.**

11.2 LIGHTING

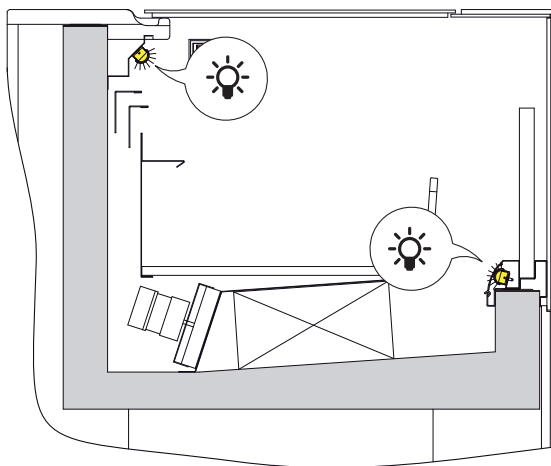

ON/OFF



11.3 GLASS



ATTENTION

Is absolutely forbidden to place weights on glass surfaces.

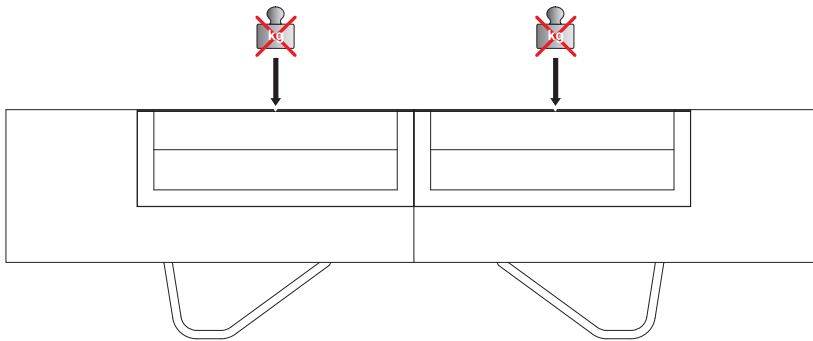
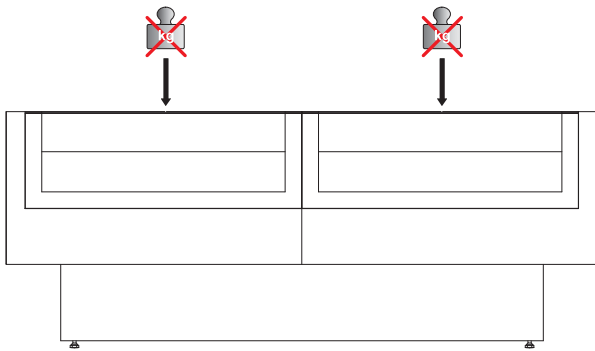
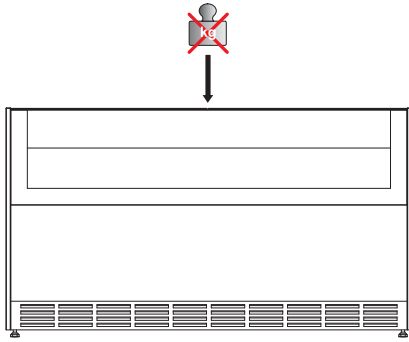

12. CONTROL PANEL

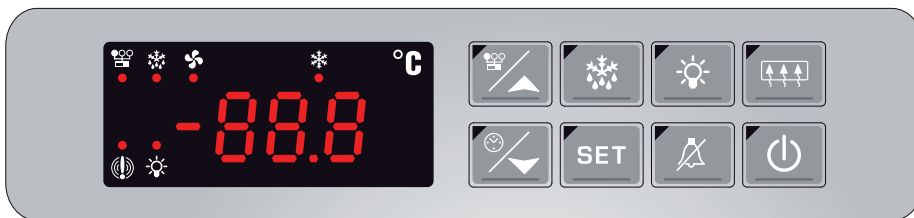
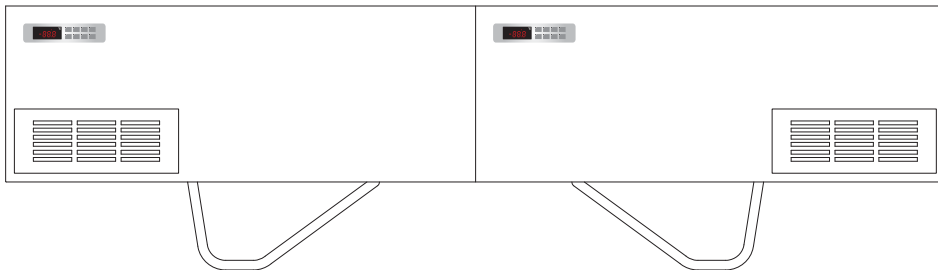
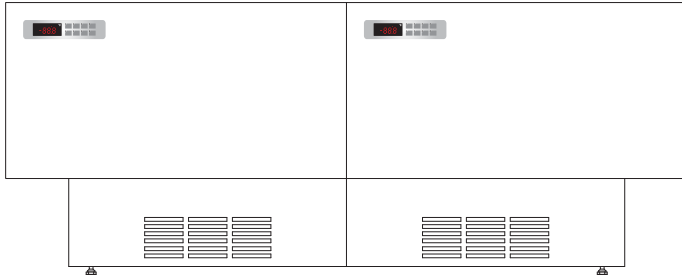
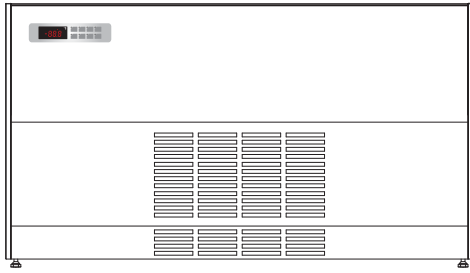

START-UP

Plug the appliance in at the socket supplied by the customer, ensuring that the plug is fitted with an earth contact and that there are no multiple sockets connected to it.

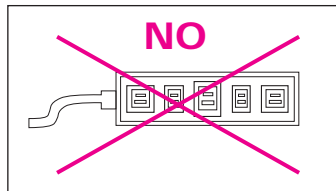
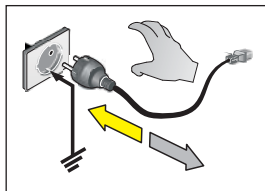

The appliance will start working automatically

otherwise press the key



OFF

Press the keys



otherwise detach the power plug.

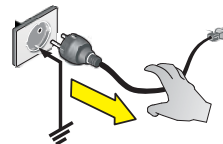







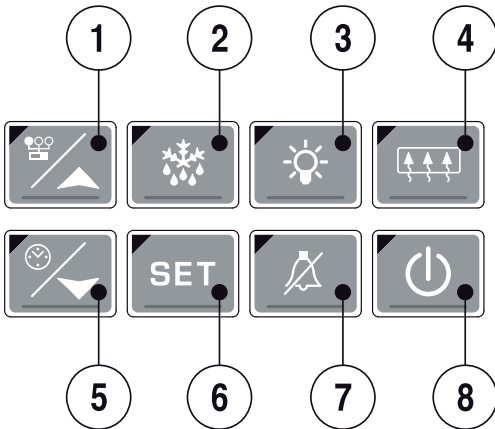

WARNING



The electronic control board is installed already programmed.

Any changes to the control board settings can be carried out exclusively by qualified technical personnel.

12.1 USER INTERFACE



BUTTON	PRESSURE SINGLE BUTTON
1	 In program, it pages through the codes of the parameters or increases the value. If it is pressed for 3 seconds it allows access to the section menu.
2	 Holding it pressed in for 3 seconds starts the manuale defrost cycle. If pressed during display time, it allow the defrosting scheduled to be set-up.
3	 Turns the lights ON / OFF.
4	 Activate the continuous way, the antiswet system if they on working in the duty cycle mode.
5	 In programming, it pages through the parameters or decreases the values. If pressed for 3 seconds, it shows the current time and day and enables access to programming and time slots.
6	 View or modify the set point. Select a parameter or confirm a value in programming.
7	 Switch OFF.
8	 Turns the equipment ON / OFF. Will be displayed OFF or - - - when the controller is in stand-by mode.

BUTTON	PRESSURE COMBINED WITH OTHER BUTTONS
TO LOCK THE KEYBOARD	
	Hold down the buttons (1) and (5) for a few seconds until the message "POF" flashing.
	At this point the keyboard is locked: it is only possible the viewing of the set point, the maximum and minimum temperature.
TO UNLOCK THE KEYBOARD	
	Hold down the buttons (1) and (5) for a few seconds until the message "POn" flashing.

12.1 USER INTERFACE

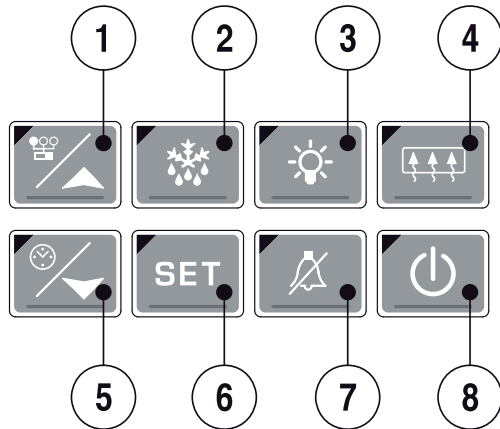

BUTTON PRESSURE SINGLE BUTTON

TO SEE AND MODIFY THE SET POINT



1. Press and release the SET key (6): the set point will be displayed immediately.
2. The SET LED flashes.
3. To change the Set value push the buttons (1) and (5).
4. To memorize the new set point, press the SET button (6) or wait 15 seconds to exit programming.



TO START A MANUAL DEFROST

Press the button (2) for more than 2 seconds.

ON/OFF FUNCTION

Press the button (8) the instrument shows "OFF" for 5 seconds and the LED ON / OFF switch lights.



In this configuration, the loads and all settings are disabled. To switch the instrument on, push the button again (8).

The OFF condition can be excluded from the monitoring tool without generating any kind of alarm.

N.B.: In LIGHTS OFF key (3) and AUX (X) are active.

TO SEE THE CURRENT TIME AND DAY

1. Press the button for 3 seconds (5).
2. You will see the following messages:



Hur (hour)
Min (minutes)
Day (day)
Monday, Tuesday, Wednesday, Thursday, Friday, Saturday, Sunday

Press the button (5) or wait 5 seconds to display the normal temperature.

TO SET THE TIME AND THE HOLIDAYS











1. Press the button for 3 seconds (5).
2. You will see the hour and day.
3. Pressing the SET key (6) will be able to set the hour, the minute, the current day and the three days of the week Holidays.



4. To exit, press SET (6) + (5), when a parameter is displayed or wait 15 seconds without pressing any key.

12.1 USER INTERFACE



LED	SIGNIFICATION
	ON: Solenoid valve activated BLINKING: Programming phase (blinking together with LED )
	ON: Fan on BLINKING: Programming phase (blinking together with LED )
	ON: Defrost activated BLINKING: Dripping time in process
	ON: Keyboard in "ALL" mode BLINKING: Keyboard in RVM mode (remote control)
	ON: Alarm signal In program "Pr2" indicates that the parameter is also present in "Pr1"
	ON: Lights on

12.1 USER INTERFACE

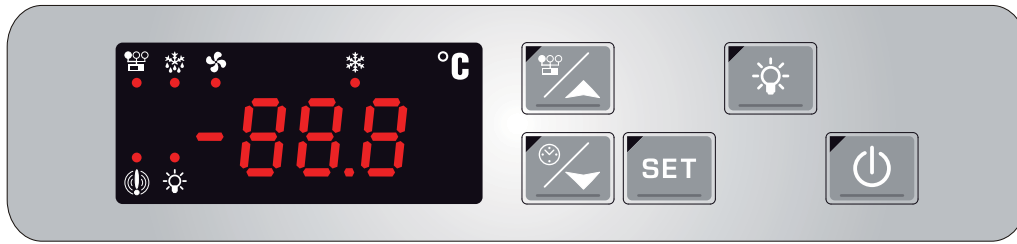

BUTTON PRESSURE SINGLE BUTTON



To view or change the set point.
In programming mode it selects a parameter or confirm an operation.
If pressed for 3 seconds while the maximum or the minimum temperature reset.



To see the maximum temperature reached.
In programming it scrolls the parameter codes or increases the value.



To see the minimum temperature.
In programming it scrolls the parameter codes or increases the value.



Turns the lights ON / OFF.



Turns the equipment ON / OFF.

BUTTON

PRESSURE COMBINED WITH OTHER BUTTONS



+



Pressed for 3 seconds lock and unlock the keyboard.



+



To access programming.



+



To exit programming.

12.1 USER INTERFACE

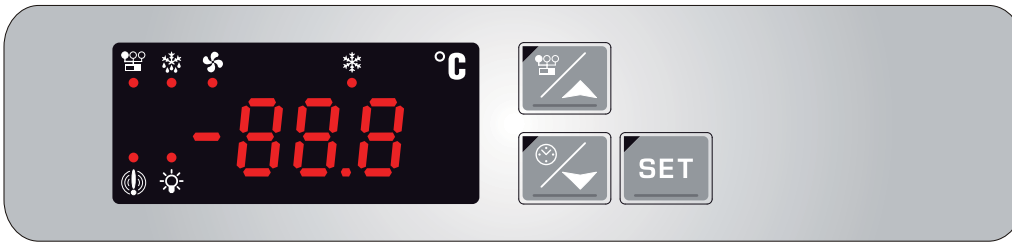

TO SEE THE MIN TEMPERATURE



- Press and release the button.
- You will see the message "Lo" followed by the minimum temperature.
- Press the button or wait 5 seconds to display the normal temperature.

TO SEE THE MAX TEMPERATURE



- Press and release the button.
- You will see the message "Hi" followed by the maximum temperature.
- Press the button or wait 5 seconds to display the normal temperature.



TO SEE AND MODIFY THE SET POINT



- Press and release the SET key: the set point will be displayed immediately.



- The leds  e  start flashing.

- To change the value push  and .

- To store the new set point value push the SET key or wait 15 seconds before leaving the program.



TO DELETE STORED TEMPERATURE



- To clear the temperatures stored, view the max or min temperature push the keys



 and .

- Press the SET key until the message "rST" flashes three times.



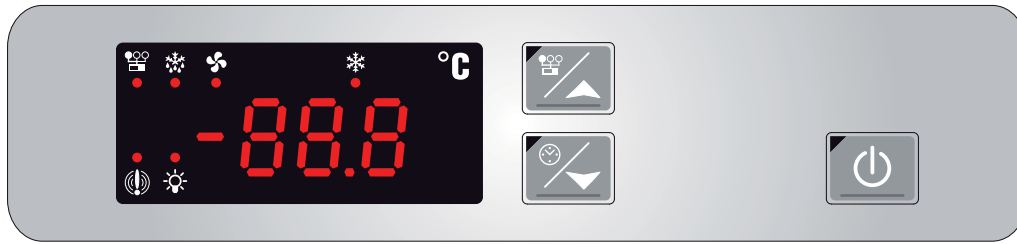

12.1 USER INTERFACE



LOCK / UNLOCK KEYBOARD

TO LOCK THE KEYBOARD



- Hold keys  and  for a few seconds until the message "POF" flashing. At this point, the keyboard is locked; It permitted only to see the set point, the maximum and minimum temperature.



TO UNLOCK THE KEYBOARD

- Hold keys  and  for a few seconds until the message "POn" flashing.

ON / OFF

By pressing the button the instrument displays "OFF".



In this configuration, the all adjustments are disabled.

To return the instrument ON, press the button again.

The condition of "OFF" can be excluded from the monitoring tool without generate no alarm type.

13. CLEANING

The materials listed below must be cleaned as follows:

STAINLESS STEEL	Only use warm water and non-aggressive detergents and then rinse and dry using a soft cloth.
ACRYLIC OR POLYCARBONATE	Wash with lukewarm water, using a soft cloth or a chamois cloth. Do not use abrasive cloths or sponges.
GLASS	Only use products specifically designed for cleaning glass. We do not recommend using tap water, which may leave calcium deposits on the surface of the glass.

13.1 INTERNAL

ATTENTION



Do not scrape the ice from the walls with pointed tools, the surfaces will be ruined. Do not use high pressure appliances (e.g. steam generators).

1. Remove the product contained in the refrigerated compartment and place it immediately in a special refrigerator conservative to ensure proper storage.
2. Turn off the equipment.

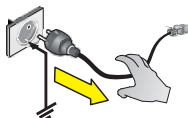

3. Remove accessories manually removable (e.g.. Sliding, grills, ice cream containers, etc).
4. Wait at least 4 to 6 hours, until the ice on the evaporator has melted completely, before proceeding with cleaning operations. We suggest in this regard, you wait for the next day to make sure that the defrosting is completely done. Do not use mechanical devices or other means to accelerate the defrosting process, other than those recommended by the manufacturer.
5. Remove (if present) the drain plug of the tank bottom to drain the defrost water.
6. Clean the side panels and the bottom of the tank using a mild detergent, warm water and a cloth or sponge. Do not use sharp tools. Rinse thoroughly and dry with an absorbent cloth.
7. If the equipment was joined to a floor drain, slide lukewarm water containing a sanitizing solution suited to the specific application. The amount of solution to be used should be such as to ensure a perfect removal of any residual product and proper sanitation along the entire path of the drainage.
8. If the equipment is not joined to a floor drain, follow the procedure referred to above. The rinse water collected in the tank will be positioned inside the base of the apparatus. Clean and disinfect the collection tray.
9. Fit the accessories that were removed (step 3).
10. Turn on the equipment and allow to cool on the bench until it reaches the desired temperature before reintroducing foods.

13.2 CONDENSING UNIT



ATTENTION

Turn off the product, wait a few hours until the equipment of the condensing unit has reached a temperature close to that of the environment.

Remove the protective grid and remove as shown.

Clean the condensing unit using a suction brush. Clean the condenser with a soft bristle brush; **make sure you do not bend the condensing unit springs whilst cleaning it.**

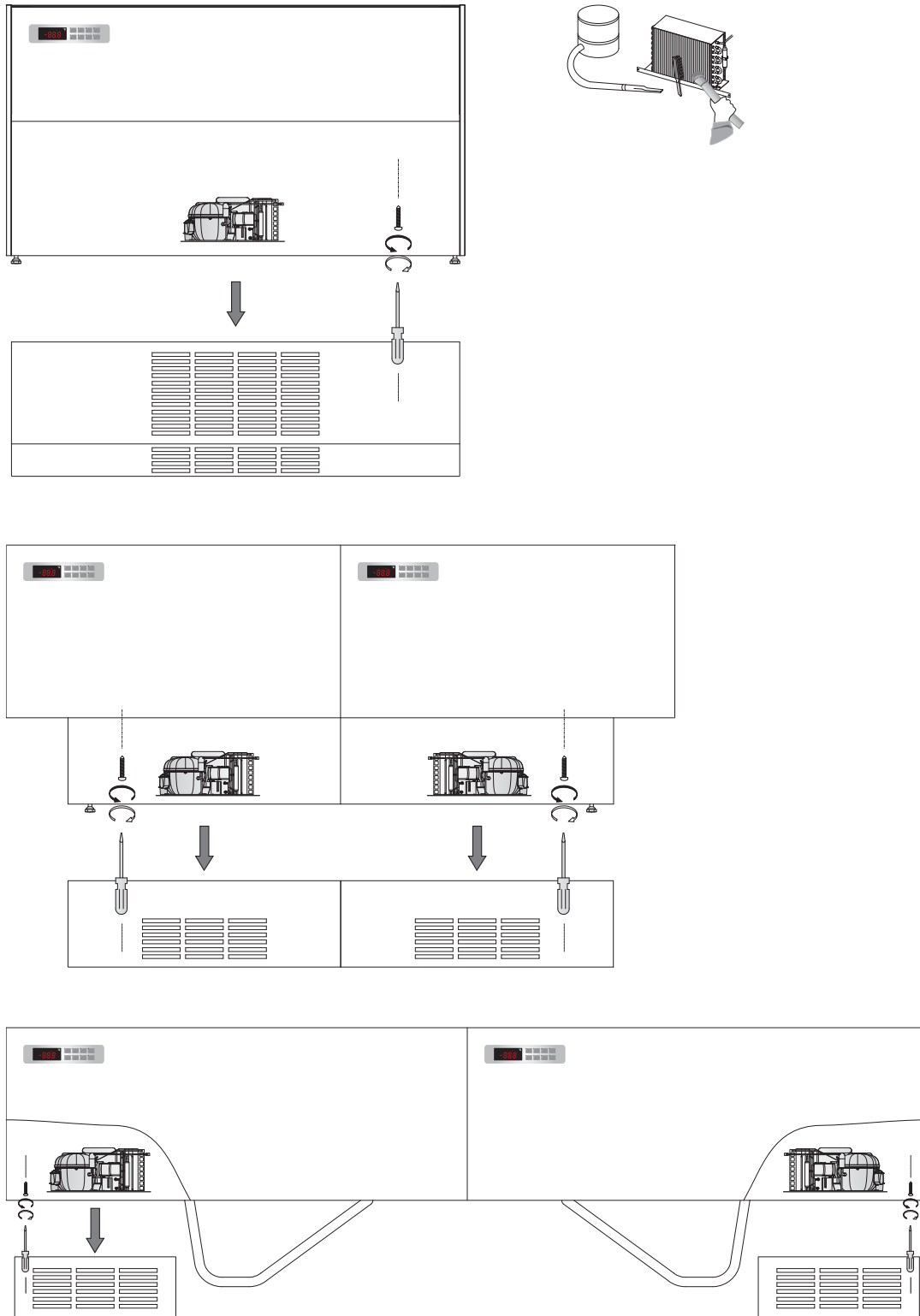

13.3 DEFROST WATER COLLECTION TRAY (IF PRESENT)

ATTENTION



Clean based on use and as needed and in certain environmental conditions (e.g., high humidity, low environmental temperature, presence of dust, etc.) in order to avoid the incorrect and complete evaporation of the water and/or the presence of unpleasant odours.

Sanitise the tray with specific products.

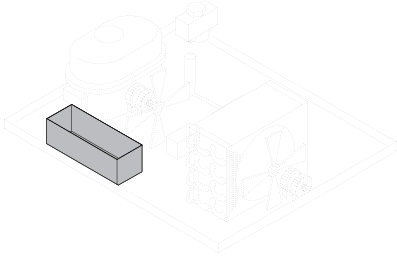

13.4 POLICARBONATE CONTAINERS

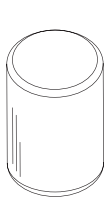

ATTENTION

Wash in cold or room temperature water not higher than **50 °C**.
It is **absolutely forbidden** to clean the dishwasher.

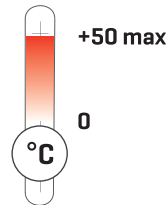

14. PROLONGED APPLIANCE SWITCH-OFF

- Remove the product contained in the refrigerated compartment and place it immediately in a special refrigerator conservative to ensure proper storage.
- Open the equipment and wait for it to reach room temperature and then clean it.
- Leave the door/sliding panels open by 2-3 cm so as to guarantee circulation of the air and prevent the formation of mould and bad smells inside the appliance.
- The appliance, with or without the packaging, should be carefully stored inside warehouses or in areas away from the elements and direct sunlight, at a temperature between **0** and **+40 °C**.

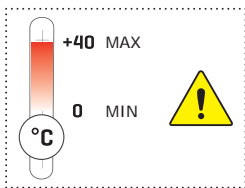

1 WIRING DIAGRAM - 412100804000 - 1/2

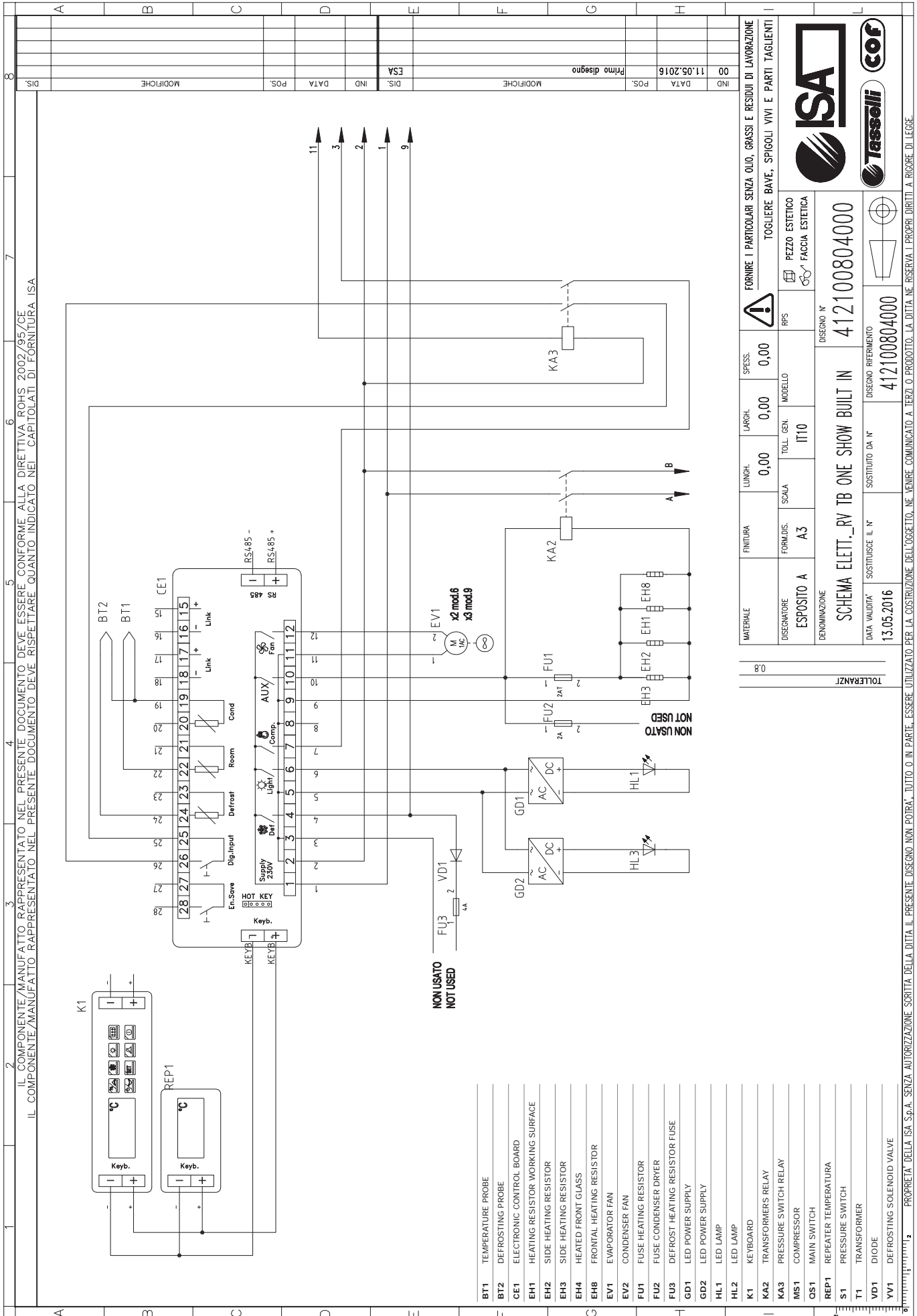

IND	00	DATA	11.05.2016	POS.	Primo disegno
IND	DIS.	MODIFICHE	DIS.	IND	DATA
IND	MODIFICHE	POS.	MODIFICHE	IND	DATA
IND	MODIFICHE	POS.	MODIFICHE	IND	DATA

FORNIRE I PARTICOLARI SENZA OLIO, GRASSI E RESIDUI DI LAVORAZIONE
 TOGLIERE BAVE, SPICOLI VIVI E PARTI TAGLIANTI

PEZZO ESTETICO
 FACCE ESTETICA

DISEGNO N° 412100804000
 SCHEMA ELETT._RV TB ONE SHOW BUILT IN
 DISEGNO RIFERIMENTO 412100804000

DATA VALIDITA' 13.05.2016
 SOSTITUISCE IL N°
 SOSTITUITO DA N°

DENOMINAZIONE
 ESPOSITO A A3
 TOLL. GEN. IT10
 SCALA
 MODELLO

RIF. TOLETRANZI

PROPRIETA' DELLA ISA S.p.A. SENZA AUTORIZZAZIONE SCRITTA DELLA DITTA IL PRESENTE DISEGNO NON POTRA' TUTTO O IN PARTE, ESSERE UTILIZZATO PER LA COSTRUZIONE DELL'OGGETTO. NE' VENIRE COMUNICATO A TERZI O PRODOTTO. LA DITTA NE' RISERVA I PROPRI DIRITTI A RICORRE DI LEGGE.

