

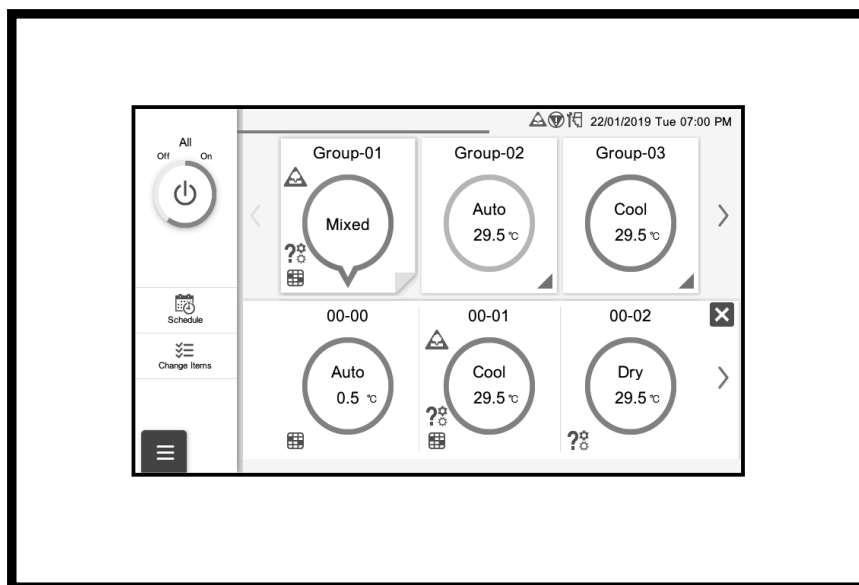

OPERATING MANUAL

CENTRAL REMOTE CONTROLLER

KEEP THIS MANUAL FOR FUTURE REFERENCE



UTY-DCGYZ1

UTY-DCGGZ1

[Original instructions]



PART NO. 9378379206-02

Contents

1. INTRODUCTION	
1-1. Safety Precautions	4
1-2. System Outlines	5
1-2-1. Features of This System	5
1-2-2. Remote Controller Group and Address Setting	6
1-3. System Configuration	7
1-4. General Usage	8
1-4-1. Name of Part	8
1-4-2. General Screen Specification	9
1-5. Initial Setting	12
2. CONTROL	
2-1. Monitoring Screen	13
2-1-1. Change Items Setting	16
2-2. Operation Setting	16
2-2-1. Batch Setting	16
2-2-2. Individual Setting	17
2-3. Schedule Setting	19
2-3-1. Schedule Detail Setting	20
2-3-2. Timer Detail Setting	21
2-3-3. Batch Day Off	24
3. SETTING	
3-1. Group Setting	26
3-1-1. Group Setting	26
3-2. Preference	27
3-2-1. Backlight Setting	27
3-2-2. Panel Calibration	27
3-2-3. Sound Setting	28
3-2-4. Date Setting	28
3-2-5. Password Setting	30
3-3. Maintenance	31
3-3-1. Error History	31
3-3-2. Display Sensor Values	31
3-3-3. Information	32
3-4. Installer Setting	33
3-4-1. Language Setting	33
3-4-2. Central Controller Address Setting	33
3-4-3. Indoor Unit Registration	34
3-4-4. Temp. Unit Setting	36
3-4-5. Remote Setting	36
3-4-6. External Input Setting	37
3-4-7. Mail Setting	38
3-4-8. Timer Setting	39
3-4-9. Initialization	40
4. REMOTE CONTROL OPERATION	
4-1. Remote Operation Setting	42
4-2. Monitor	42
4-2-1. Monitoring screen	42
4-2-2. Operation	43
4-3. Change Password	43
4-4. Unit display order	43
4-5. Environment Setting	44
5. TROUBLESHOOTING	
5-1. Error	45
5-2. Emergency Stop	46
5-2-1. When a signal is received from external input	46
5-2-2. When a signal is received from VRF system	46
5-3. Error Code	46
6. SPECIFICATIONS	

License

- For the screen display, this product uses a Bitmap font made and developed by Ricoh Company, Ltd.
- Cypherbridge_Systems_SLA_Copyright

Copyright (C) 2009-2018 Cypherbridge Systems, LLC.

All Rights Reserved.

www.cypherbridge.com

Portions of this work may be based on third party contributions.

Cypherbridge Systems LLC reserves copyrights to this work whose license terms are defined under a separate Software License Agreement (SLA). Re-distribution of any or all of this work, in source or binary form, is prohibited unless authorized by Cypherbridge Systems, LLC under SLA, which governs the terms and conditions for use.

THIS SOFTWARE IS PROVIDED BY THE COPYRIGHT HOLDERS AND CONTRIBUTORS "AS IS" AND ANY EXPRESS OR IMPLIED WARRANTIES, INCLUDING, BUT NOT LIMITED TO, THE IMPLIED WARRANTIES OF MERCHANTABILITY AND FITNESS FOR A PARTICULAR PURPOSE ARE DISCLAIMED. IN NO EVENT SHALL THE COPYRIGHT OWNER OR CONTRIBUTORS BE LIABLE FOR ANY DIRECT, INDIRECT, INCIDENTAL, SPECIAL, EXEMPLARY, OR CONSEQUENTIAL DAMAGES (INCLUDING, BUT NOT LIMITED TO, PROCUREMENT OF SUBSTITUTE GOODS OR SERVICES; LOSS OF USE, DATA, OR PROFITS; OR BUSINESS INTERRUPTION) HOWEVER CAUSED AND ON ANY THEORY OF LIABILITY, WHETHER IN CONTRACT, STRICT LIABILITY, OR TORT (INCLUDING NEGLIGENCE OR OTHERWISE) ARISING IN ANY WAY OUT OF THE USE OF THIS SOFTWARE, EVEN IF ADVISED OF THE POSSIBILITY OF SUCH DAMAGE.

Portions based on XySSL Copyright (C) 2006-2008 Christophe Devine

Copyright (C) 2009 Paul Bakker <polarssl_maintainer@polarssl.org> All rights reserved.

Redistribution and use in source and binary forms, with or without modification, are permitted provided that the following conditions are met:

Redistributions of source code must retain the above copyright notice, this list of conditions and the following disclaimer.

Redistributions in binary form must reproduce the above copyright notice, this list of conditions and the following disclaimer in the documentation and/or other materials provided with the distribution.

Neither the names of PolarSSL or XySSL nor the names of its contributors may be used to endorse or promote products derived from this software without specific prior written permission.

Portions based on MBEDTLS

Copyright (C) 2006-2015, ARM Limited, All Rights Reserved

SPDX-License-Identifier: Apache-2.0

Distributed on an "AS IS" BASIS, WITHOUT WARRANTIES OR CONDITIONS OF ANY KIND, either express or implied.

You may obtain a copy of the Apache License at <http://www.apache.org/licenses/LICENSE-2.0>

1. INTRODUCTION

1-1. Safety Precautions

- The “Safety Precautions” indicated in the manual contain important information pertaining to your safety. Be sure to observe them.
- For details of the operation methods, refer to the manual.
- Request the user to keep the manual on hand for future use, such as for relocating or repairing the unit.

 WARNING	This mark indicates procedures which, if improperly performed, might lead to the death or serious injury of the user.
<ul style="list-style-type: none">• In the event of a malfunction (burning smell, etc.), immediately stop operation, turn off the electrical breaker, and consult authorized service personnel.	
<ul style="list-style-type: none">• Do not repair or modify any damaged cable by yourself. Let the authorized service personnel to do it. Improper work will cause an electric shock or a fire.	
<ul style="list-style-type: none">• When moving, consult authorized service personnel for uninstallation and installation of this unit.	
<ul style="list-style-type: none">• When disposing, consult an authorized service representative.	
<ul style="list-style-type: none">• When disposing of the product is used, be based on national regulations, properly processed.	
<ul style="list-style-type: none">• Do not touch with wet hands. It may cause an electric shock.	
<ul style="list-style-type: none">• If children may approach the unit, take preventive measures so that they cannot reach the unit.	
<ul style="list-style-type: none">• Do not repair or modify by yourself. It may cause a fault or accident.	
<ul style="list-style-type: none">• Do not use flammable gases near the unit. It may cause a fire from leaking gas.	

 CAUTION	This mark indicates procedures which, if improperly performed, might possibly result in personal harm to the user or damage to property.
<ul style="list-style-type: none">• Do not set vessels containing a liquid on this unit. Doing so will cause heating, fire or electric shock.	
<ul style="list-style-type: none">• Do not expose this unit directly to water. Doing so will cause trouble, electric shock or heating.	
<ul style="list-style-type: none">• Dispose of the packing materials safely. Tear and dispose of the plastic packing bags so that children cannot play with them. There is the danger of suffocation if children play with the original plastic bags.	
<ul style="list-style-type: none">• Do not place electrical devices within 1 meter of this unit. It may cause malfunction or failure.	
<ul style="list-style-type: none">• Do not use fire near this unit or place a heating apparatus nearby. It may cause malfunction.	
<ul style="list-style-type: none">• Do not touch the switches with sharp objects. Doing so will cause injury, trouble, or electric shock.	
<ul style="list-style-type: none">• This appliance is not intended for use by persons (including children) with reduced physical, sensory or mental capabilities, or lack of experience and knowledge, unless they have been given supervision or instruction concerning use of the appliance by a person responsible for their safety. Children should be supervised to ensure that they do not play with the appliance.	

1-2. System Outlines

1-2-1. Features of This System

- This Central remote controller is a management device to perform the centralized control of VRF2 system. This Central remote controller can control 100 indoor units and 100 outdoor units. (hereafter called “this controller”)
- This controller can monitor the air conditioners (indoor units and outdoor units) by acquiring their sensor value.
- The batch operation / batch stop signal or emergency stop signal can be input by external input. Or operation/stop status signal or abnormal/normal status signal can be output by external output.
- This controller can be controlled remotely using tablet, etc. by the remote connection of wired LAN.

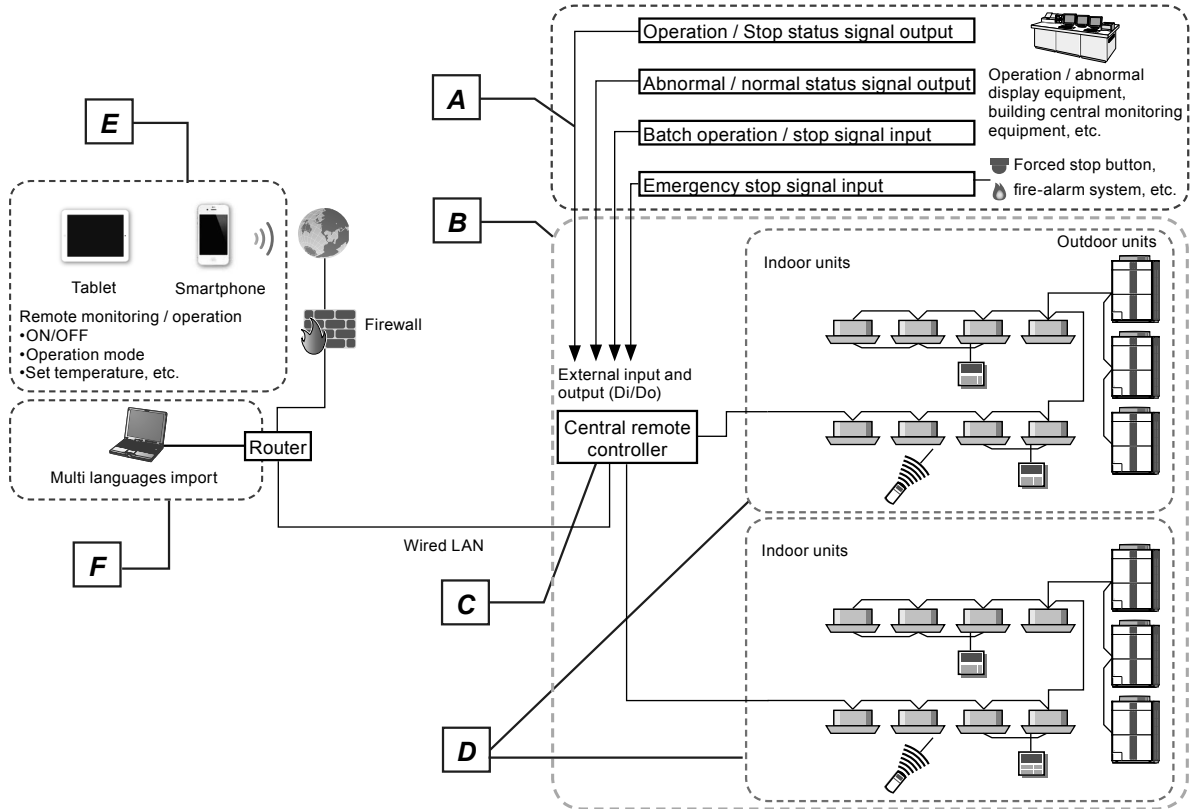

	Name	Description
A	External input and output to general-purpose equipment	External input from general-purpose equipment to VRF system (batch operation/stop, emergency stop) is enabled. Or external output from VRF system to general-purpose equipment (operation/stop signal, normal/abnormal signal) is also enabled.
B	VRF System	This is all of the indoor units, outdoor unit as well as those of relevant control equipment (Central remote controller, standard remote controllers) that are connected with the same transmission cable.
C	Central remote controller:	The Central remote controller is a remote controller that allows centralized control of multiple indoor units. A Central remote controller can control the operation of the indoor units and timers in 3 units: All, Group and Individual. Moreover, 1 Central remote controller can control up to 100 indoor units and 16 groups.
D	Refrigerant system	This is a system that is composed of indoor units, outdoor unit as well as those of relevant control equipment. All of the units and the equipment are connected with pipes with the same refrigerant.
E	Remote control operation	This controller can be controlled remotely using tablet, etc. by the remote connection of wired LAN. For details, refer to Chap. 4 .
F	Language importance	<ul style="list-style-type: none"> • Standard installed languages (12 languages): English, Spanish, German, French, Italian, Russian, Portuguese, Turkish, Polish, Greek, Dutch, and Simplified Chinese • Custom language (one language): One language other than the above can be imported remotely. For the addition of custom language, contact the service department.

1-2-2. Remote Controller Group and Address Setting

Address setting to this controller is required to assign the air conditioners with remote controller group.
Address is set automatically or manually for each refrigerant system.

	Name	Description
G	Refrigerant system address (0-99):	This is the ID individually assigned to each refrigerant system and is used for control.
H	Indoor unit address (00 - 63):	This is the ID individually assigned to each indoor unit and is used for control.
J	Remote controller address (0-15):	This is the group of indoor units that have been connected with remote controller cable, or single indoor unit.
K	R.C.G. address:	Remote controller group (R.C.G.) address is made up of the refrigerant system address and the indoor unit address of indoor unit with remote controller address "0". (Hereafter Remote controller group is called "R.C.G.")

Example) Refrigerant system address=00

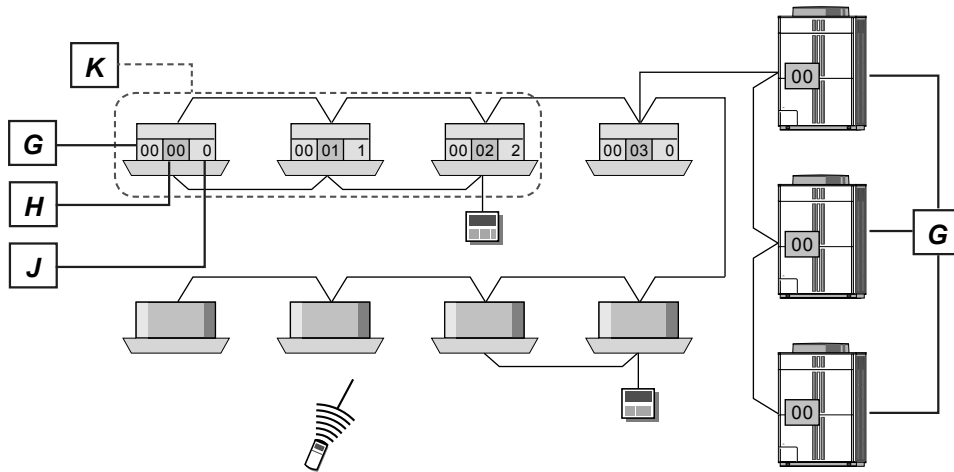

Refrigerant system address=01

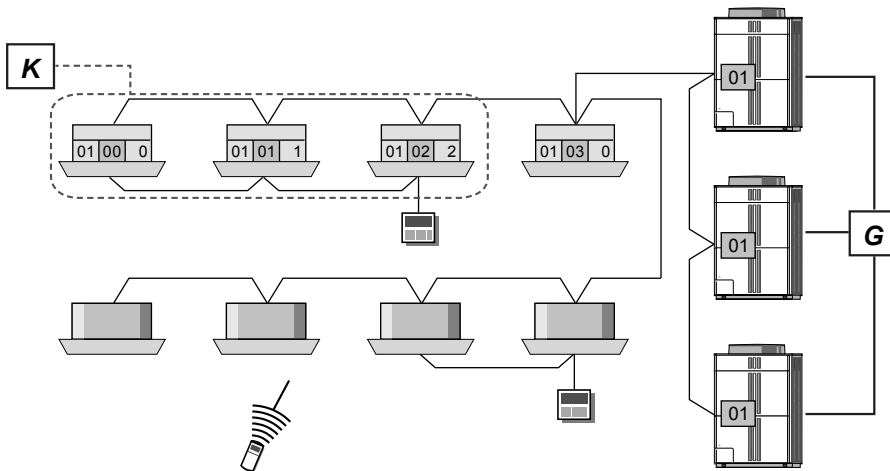

1-3. System Configuration

Monitoring screen

The air conditioner operating status can be monitored, set, and controlled.

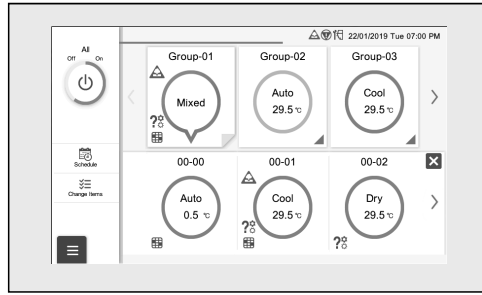

Operation system

→ Refer to Chap. 2.

Batch Setting

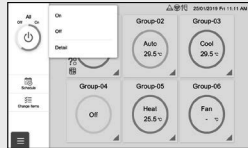

Individual Setting



Schedule Setting



Master setting system

→ Refer to Chap. 3.

Menu Select screen

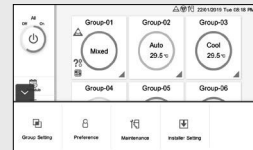

(1) Group Setting



(2) Preference



(3) Maintenance

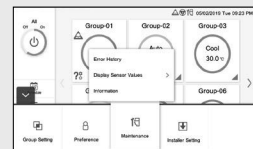

(4) Installer Setting



1-4. General Usage

This controller screens are all the touch panel display. Tap the screen to select the function.

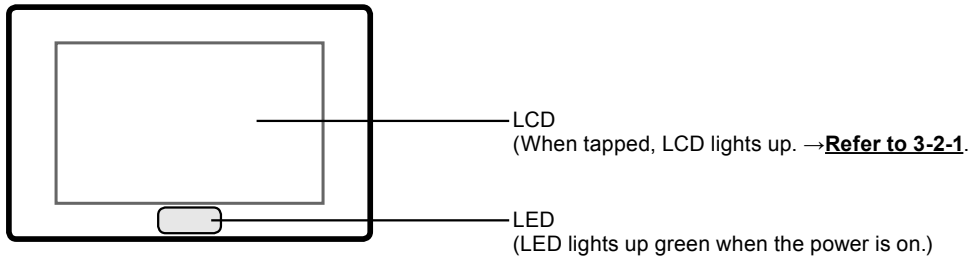

■ Features of screen input

- From main screen, you can access to desired setting screen by simple operation.
- When setting at small pop-up display in this controller, you can set while checking the information of the screen behind pop-up.

1-4-1. Name of Part

■ Main screen

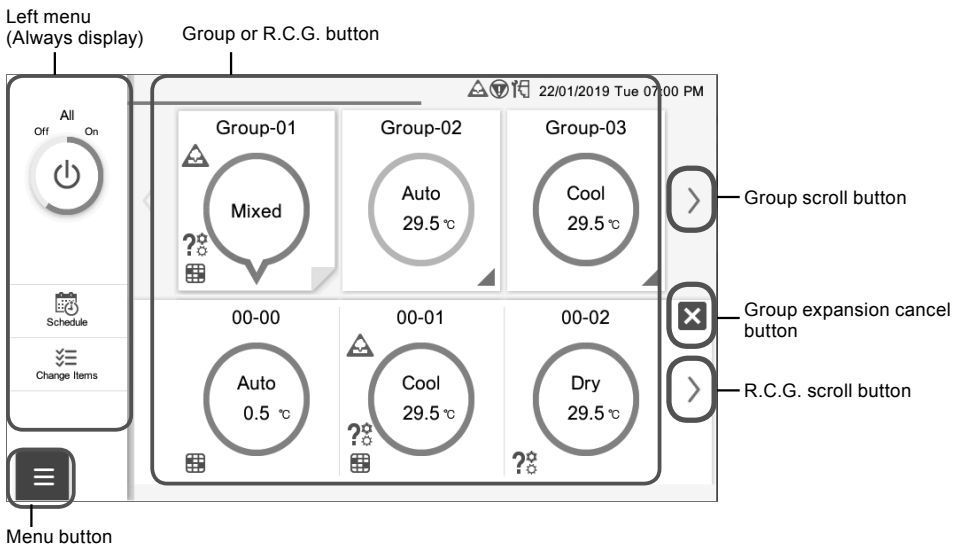

■ Other sample screen

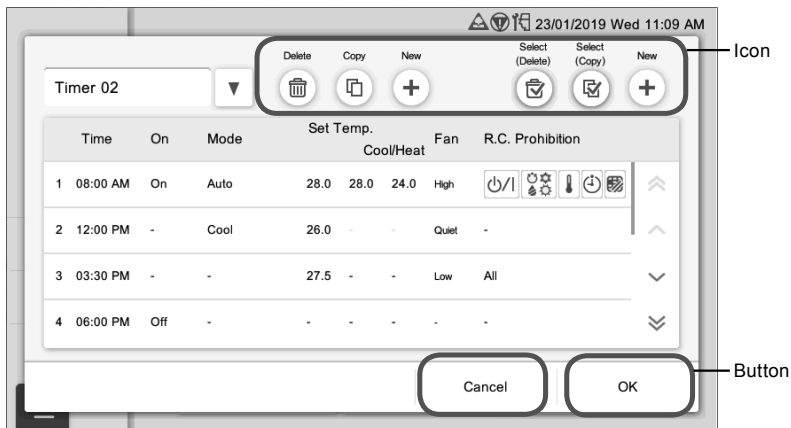

1-4-2. General Screen Specification







■ Button

The functions such as [OK] and [Cancel] are buttoned.

[OK]	Continues the appropriate process.
[Cancel]	Cancels the process and closes the current screen.
[Reset]	Returns the changed item to the initial value.
[Close]	Closes the current screen .
[End]	Ends the process and closes the pop-up.

■ Icon

The functions such as [Delete] and [Copy] are iconized.

Icon	Description
	Deletes the currently displayed setting.
	Copies the currently displayed setting.
	Adds the new timer. However, when the number of settings reaches the upper limit, this button is disabled.
	Deletes the selected line.
	Copies the selected line.
	Adds the new line. However, when the number of settings reaches the upper limit, this button is disabled.

■ Pop-up screen

- ① When the pop-up function is displayed, only the pop-up function which appears finally can be operated and other functions arranged in the screen cannot be operated.
- ② When the buttons are not displayed on the pop-up screen
When other screen is operated or 20 seconds passes after display, pop-up display is closed.
However, the following cases are excluded.
 - The setting menu (open mode) is not closed even when other screens are operated. The menu is closed after 20 minutes passes.
 - The left menu of monitoring screen is not closed even when other screen is operated or 20 minutes passes.
 - The pop-up with display releasing condition continues to display until the condition is satisfied. (For example, the pop-up display notifying that VRF system is in a special state is not closed until the special state is released.)

(Sample screen)

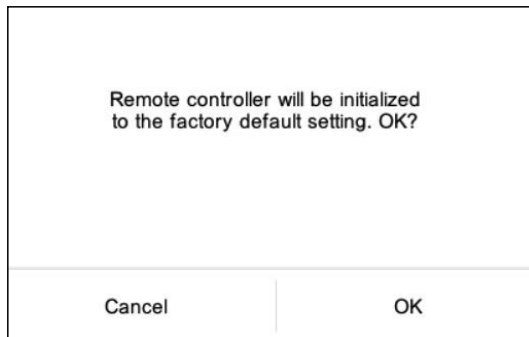

■ Menu button

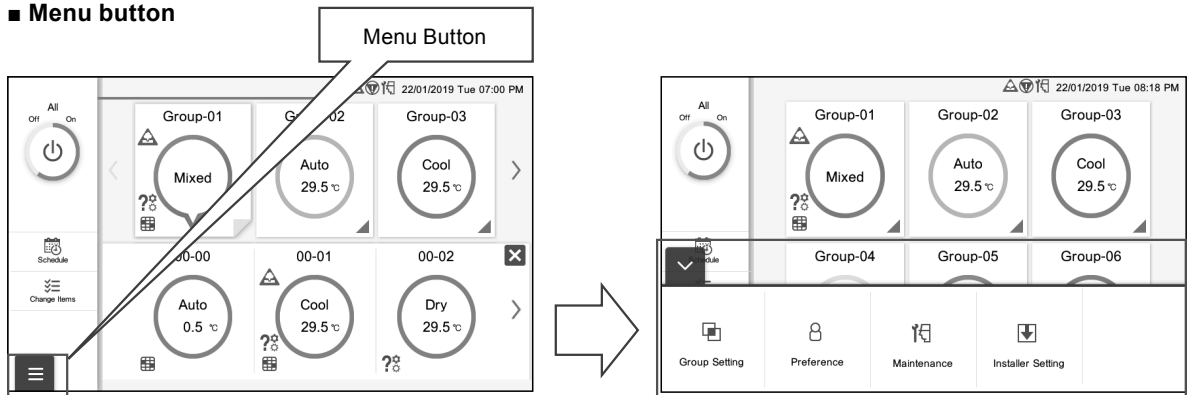

Close mode

When the Menu button is tapped, the Menu screen is displayed.

Open mode

The Menu screen is displayed and Setting menu can be selected. When tapped again, the Menu returns to the Close mode.

■ Keyboard input

Input the alphanumeric characters or Russian characters. (Keyboard is used for LAN setting or mail address setting.)

(Keyboard sample)

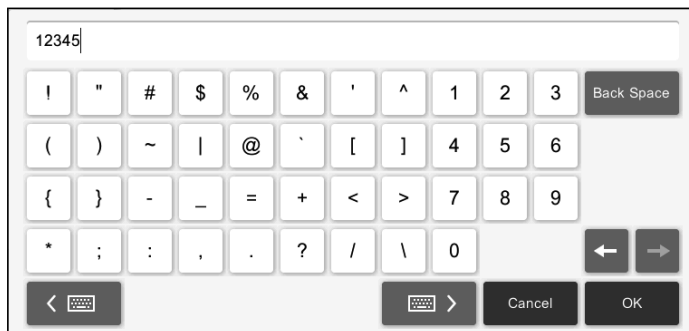
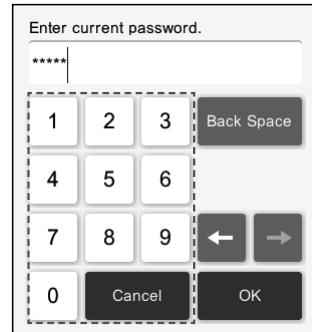

■ Screen explanation

The items in the screen image are numbered and they are explained in the following table.

* For the general buttons such as [OK], [Cancel], etc., the explanations are omitted in the table.

(Sample) Group setting

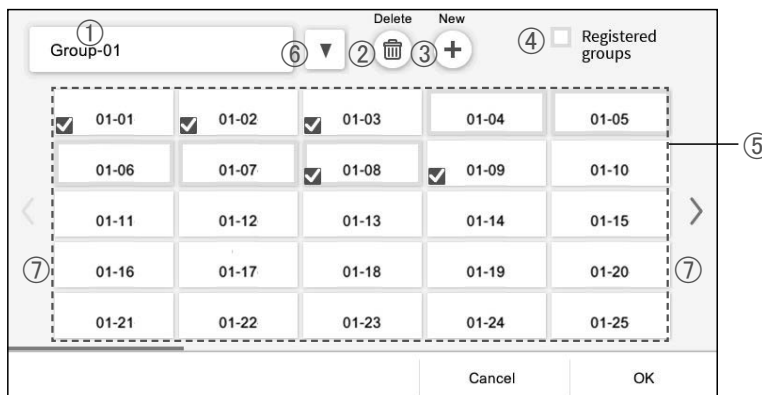

No.	Item	Description
①	Group name	Registers the group name. (Max. 13 characters) Up to 50 groups can be registered.
②	[Delete] icon	Deletes the group. When there is no group after deletion, "There is no group to display." is displayed.
③	[New] icon	Adds the group. When the number of registered groups reaches 50, this button is disabled.
④	Already selected R.C.G.	Indicates that the R.C.G. is already selected by other groups.
⑤	R.C.G. list	When selected, checkbox is checked. Up to 100 R.C.G. can be registered for one group.
⑥	Group switch-over button	Switches over the displayed group.
⑦	R.C.G. scroll buttons	The right and left scroll buttons are displayed when R.C.G. are more than 25.

1-5. Initial Setting

After Central remote controller installation work is complete, perform initial setting by the following procedure before starting to use the system.

**Turn on the power
(Breaker ON)**



Initial setting start

Only when the power is turned on for the first time or immediately after initialization is set, the following wizard are displayed in wizard format. Perform the settings.

(1) **Language Setting**→Refer to 3-4-1(4).

(2) **Panel Calibration**→Refer to 3-2-2(4).

(3) **Central Controller Address Setting**→Refer to 3-4-2(4).

(4) **Indoor Unit Registration**→Registration→Refer to 3-4-3-3.

(5) **Date Setting**→Refer to 3-2-4-1, 3-2-4-2.

* Automatic scan for all units connected at initial start-up is performed and one group is created.

Monitoring screen is displayed. Perform the settings as necessary.→Refer to Chap. 3.

Initial setting end



**Operation start
(Refer to Chap. 2.)**

Air conditioning starts on the Monitoring screen.

2. CONTROL

2-1. Monitoring Screen

For the registered group, operation status can be checked or set in any of 6 groups or 12 groups display. The sample below is the screen of 6 groups display.



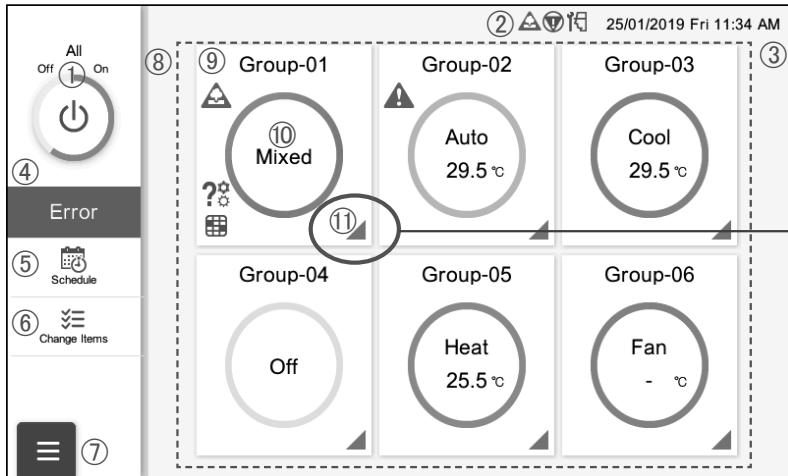



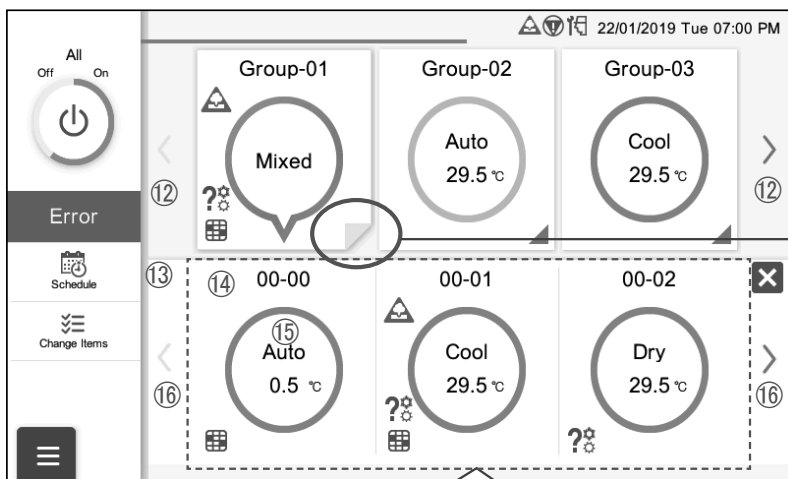

- The groups registered at group setting are displayed on the Monitoring screen. → [Refer to 3-3-1](#).
- The display item can be set on the Monitoring screen. → [Refer to 2-1-1](#).



- When the triangle mark on the bottom-right corner is tapped, the R.C.G. belonging to the group are displayed.
- When the R.C.G. are expanded, the bottom-right corner of square seems to be folded.

















R.C.G. are expanded in dotted line. (R.C.G. belonging to the tapped group are displayed.)

No.	Item	Description								
①	All R.C.G. On/Off	When the password setting is valid, input the password after selecting the process in the followings. "All ON": Sets all R.C.G. registered to this controller to ON collectively. The operation of all R.C.G. is turned On or Off collectively. → Refer to 2-1-1. "Detail": Sets the operation contents in details. → Refer to 2-2-2. On/Off icon: Colorfully indicates the ratio of operation On status for the number of registered R.C.G.. Green: Operation On status, Gray: Operation Off status								
②	Special state display	Only when even one registered indoor unit or outdoor unit is in the following special state, the icon is displayed. <table border="1" data-bbox="552 415 1218 600"> <thead> <tr> <th>Icon</th> <th>State</th> </tr> </thead> <tbody> <tr> <td></td> <td>Refrigerant leakage</td> </tr> <tr> <td></td> <td>Emergency stop</td> </tr> <tr> <td></td> <td>Maintenance mode / Bus priority</td> </tr> </tbody> </table>	Icon	State		Refrigerant leakage		Emergency stop		Maintenance mode / Bus priority
Icon	State									
	Refrigerant leakage									
	Emergency stop									
	Maintenance mode / Bus priority									
③	Date	Displays the date and time.								
④	Error display	When even one unit is abnormal in the registered indoor units or outdoor units, [Error] icon is displayed. Displays error information as follows: <ul style="list-style-type: none"> • "Error Code": Displays the error code. • "Address": Displays the address of the unit where an error occurs. • "Model Name": Displays the model name of the unit where an error occurs. • Model Name: Displays as follows: Outdoor unit: Outdoor Unit Indoor unit: Group name or R.C.G. name This controller: Central Controller 								
⑤	[Schedule] icon	Displays the operation schedule setting screen. → Refer to 2-3.								
⑥	[Change Items] icon	Sets the contents to be displayed on the screen. → Refer to 2-1-1.								
⑦	Menu button	Displays the Setting Menu screen by tapping this button which is always displayed. → Refer to Chap. 3.								
⑧	Group display	Displays the groups which were already set. Displays the group operation status. → Refer to [Table 1].								
⑨	Group name	Display the group name.								
⑩	Group operation status	Sets the operation contents of the tapped group. → Refer to 2-2-2.								
⑪	Group expansion	Expands the R.C.G. registered to the group by tapping.								
⑫	Group scroll button	When the number of registered groups exceeds the maximum display limit, the right and left scroll buttons are displayed.								
⑬	R.C.G. display	Displays the R.C.G. registered to the group. (The registered R.C.G. are displayed from left to right and from the top in ascending order of system No. and unit No.)								
⑭	R.C.G. name	Displays the R.C.G. name.								
⑮	R.C.G. operation status	Displays the R.C.G. operation status. → Refer to [Table 1]. Sets the R.C.G. operation contents. → Refer to 2-2-2.								
⑯	R.C.G. scroll button	When the number of registered R.C.G. exceeds the maximum display limit, the right and left scroll buttons are displayed.								

[Table 1] Operation status

The set items are displayed at operation status.→**Refer to 2-1-1.**

Color	Icon	Operation status
Light blue	 	The operations of groups and R.C.G. are “Cool” or “Dry”.
Pink		The operations of groups and R.C.G. are “Heat”.
Purple	  	The operations of groups and R.C.G. are “Fan”, “Auto”, or “Custom Auto”.
Rainbow		The operation modes of groups are mixed.
Gray		The operations of all groups and R.C.G. are stopped.
Yellow		Even one unit of groups or R.C.G. is on a test operation. (Displayed regardless of operation mode)
—		The icons of “R.C. prohibition”, “Temp. upper and lower limit”, and “Schedule” are displayed when “Management Status” is checked.→ Refer to 2-1-1.
	 	When the room temperature is out of the room temperature sensor range, the icon of over upper limit or below lower limit is displayed.
Display icon	  	<ul style="list-style-type: none"> • When refrigerant leak, error, mismatch mode, or filter sign occurs at even one unit, the icon is displayed. • When refrigerant leak and error occur at the same time, refrigerant leak is displayed preferentially.

2-1-1. Change Items Setting

No.	Item	Description
①	“Management Status” display	When checkbox is checked, the icons of “R.C. prohibition”, “Temp. upper and lower limit”, and “Schedule” are displayed on the group. The display switches to normal icon display automatically 12 seconds after the scroll button, etc. is tapped.
②	“Operation Status” selection	Switches between enabled and disabled state of the display by checkbox. Up to 2 items of “Mode”, “Room Temp.”, “Set Temp.” can be enabled. All items cannot be disabled. When one of “Room Temp.” or “Set Temp.” is enabled or both of “Room Temp.” and “Set Temp.” are enabled, “Temp. Unit” can be enabled.
③	“Group Icon” size	Sets the group icon size to be displayed. [Initial value: Auto] “Auto”: When the number of registered group is 6 or less, icons are large. When it is 7 or more, icons are small. “Large”: Icons are large. (maximum number of display group: 6) “Small”: Icons are small. (maximum number of display group: 12)

2-2. Operation Setting

Perform the operation setting for the group or R.C.G. registered to this controller.

(1) Batch setting: Performs the same setting to all R.C.G. registered to this controller.

(2) Individual setting: Performs the individual setting for the tapped group or R.C.G..

When the password is set at start-up, enter the password. ([Refer to 3-2-5.](#))

2-2-1. Batch Setting

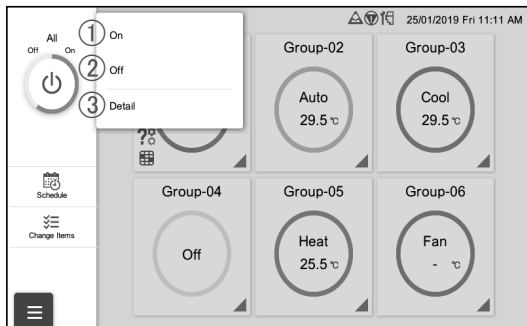

(1) Tap the following item.

No.	Item	Description
①	“On”	Sets all R.C.G. to ON collectively.
②	“Off”	Sets all R.C.G. to OFF collectively.
③	“Detail”	Sets the details of batch operation. The screen is the same as the individual setting. → Refer to 2-2-2.

2-2-2. Individual Setting

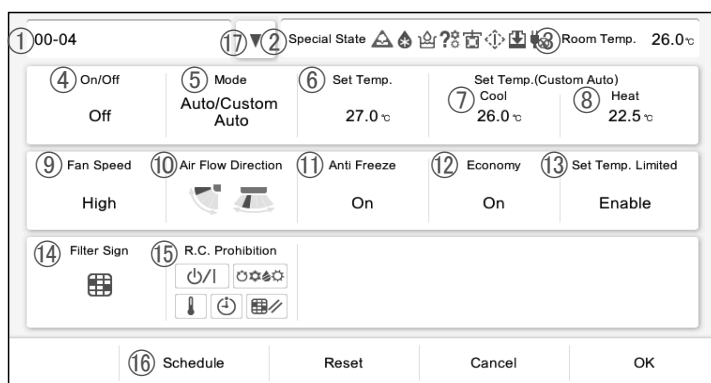

No.	Item	Description																								
①	“Group name” / “R.C.G. name”	Selects “Group name” to be set. For Batch setting, “All Indoor Units” is displayed.																								
②	“Special State”	When the currently displayed group or R.C.G. is in a special state, icon is displayed. • Displayed states when even one unit is in a special state <table border="1" style="width: 100%; border-collapse: collapse;"> <thead> <tr> <th>Icon</th> <th>State</th> <th>Icon</th> <th>State</th> </tr> </thead> <tbody> <tr> <td></td> <td>Emergency stop</td> <td></td> <td>Mismatch mode</td> </tr> <tr> <td></td> <td>Maintenance mode</td> <td></td> <td>Test operation</td> </tr> <tr> <td></td> <td>Refrigerant leakage</td> <td></td> <td>Pump down</td> </tr> <tr> <td></td> <td>Error</td> <td></td> <td>Auxiliary power supply</td> </tr> <tr> <td></td> <td>Oil recovery</td> <td>—</td> <td>—</td> </tr> </tbody> </table> • Displayed state when all units are in a special state Managed unit (when all indoor units are not master indoor unit, and master unit is managed or outdoor unit is managed)	Icon	State	Icon	State		Emergency stop		Mismatch mode		Maintenance mode		Test operation		Refrigerant leakage		Pump down		Error		Auxiliary power supply		Oil recovery	—	—
Icon	State	Icon	State																							
	Emergency stop		Mismatch mode																							
	Maintenance mode		Test operation																							
	Refrigerant leakage		Pump down																							
	Error		Auxiliary power supply																							
	Oil recovery	—	—																							
③	“Room Temp.”	Displays the room temperature.																								
④	“On/Off”	Selects “On” or “Off” for operation state.																								
⑤	“Mode”	Selects the mode. (“Auto”, “Cool”, “Dry”, “Fan” and “Heat”. Selectable mode depends on the indoor unit)																								
⑥	“Set Temp.”	Selects the “Set Temp.” with 0.5°C (1°F) in units. (except when “Fan” or “Off” is selected)																								
⑦	“Set Temp. (Custom Auto)” “Cool”*	Setting range: “Auto” 18 to 30°C (64 to 88°F)																								
⑧	“Set Temp. (Custom Auto)” “Heat”*	“Cool / Dry” 18 to 30°C (64 to 88°F) “Heat” 10 to 30°C (44 to 88°F)																								
⑨	“Fan Speed”	Sets “Fan Speed”. “Auto”, “High”, “Med-High”, “Med”, “Med-Low”, “Low”, “Quiet”																								
⑩	“Air Flow Direction”	Sets “Air Flow Direction”. → Refer to 2-2-2-1.																								
⑪	“Anti Freeze”	Sets “Anti Freeze” operation. Select “On” or “Off”.																								
⑫	“Economy”	Sets “Economy” operation. Select “On” or “Off”.																								
⑬	“Temperature Limit”	Sets “Temp. Limit”. → Refer to 2-2-2-2.																								
⑭	“Filter Sign”	Resets “Filter Sign”. (Operation accumulated time is reset.)																								
⑮	“R.C. Prohibition”	Sets “R.C. Prohibition”. → Refer to 2-2-2-3.																								
⑯	[Schedule] button	Sets “Schedule”. → Refer to 2-3.																								
⑰	Group / R.C.G. switch-over button	Switches over between group display and R.C.G. display.																								

* “Set temp.” is displayed only when a unit with Custom Auto function is registered.

Note

Custom Auto:

Set the set temperature for cooling and the set temperature for heating separately. During the Custom Auto mode operation, when the room temperature exceeds the set temperature for cooling, the cooling operation is performed, and when the room temperature falls below the set temperature for heating, the heating operation is performed. (It can be used only when the setting of the indoor unit compatible with this function is valid.)

2-2-2-1. Vertical and Horizontal Airflow Direction Setting

Set the vertical and horizontal airflow direction.

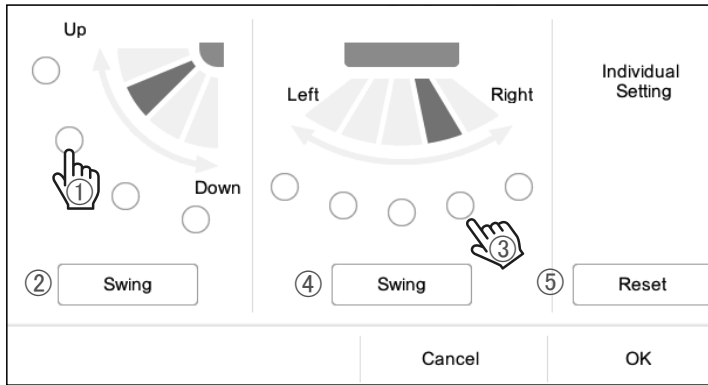

No.	Item	Description
①	Vertical airflow direction selection	Selects the airflow direction by tapping.
②	Vertical airflow direction swing	Sets the vertical airflow direction to [Swing].
③	Horizontal airflow direction selection	Selects the airflow direction by tapping.
④	Horizontal airflow direction swing	Sets the horizontal airflow direction to [Swing].
⑤	[Reset] button	Resets individual airflow direction setting.

2-2-2-2. Temperature Upper and Lower Limit Setting

Set the temperature upper and lower limit setting of "Auto", "Cool/Dry", and "Heat".

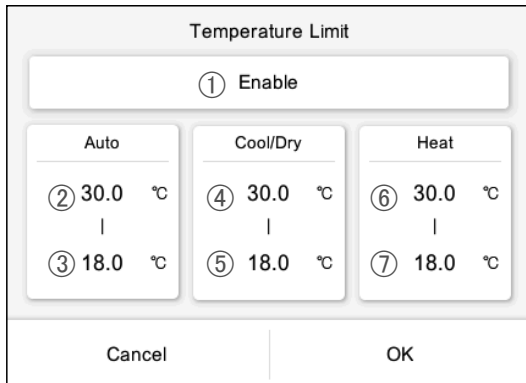

No.	Item	Description
①	Set temperature "Enable" / "Disable"	Sets "Enable" or "Disable" of upper and lower limit setting. Select from "Enable" or "Disable".
②	"Auto" upper limit	Sets the "Auto" upper limit with 0.5°C (1°F) increments. Range: 18.0 to 30.0°C (64 to 88°F)
③	"Auto" lower limit	Sets the "Auto" lower limit with 0.5°C (1°F) increments. Range: 18.0 to 30.0°C (64 to 88°F)
④	"Cool/Dry" upper limit	Sets the "Cool/Dry" upper limit with 0.5°C (1°F) increments. Range: 18.0 to 32.0°C (64 to 91°F)
⑤	"Cool/Dry" lower limit	Sets the "Cool/Dry" lower limit with 0.5°C (1°F) increments. Range: 18.0 to 32.0°C (64 to 91°F)
⑥	"Heat" upper limit	Sets the "Heat" upper limit with 0.5°C (1°F) increments. Range: 10.0 to 30.0°C (48 to 88°F)
⑦	"Heat" lower limit	Sets the "Heat" lower limit with 0.5°C (1°F) increments. Range: 10.0 to 30.0°C (48 to 88°F)

2-2-2-3. Remote Controller Prohibition Setting

Set the prohibited operations of remote controller.

①	All	On/Off	On	Mode	Temp.	Timer	Filter Reset
	<input type="checkbox"/>	<input type="checkbox"/>	<input checked="" type="checkbox"/>	<input checked="" type="checkbox"/>	<input type="checkbox"/>	<input checked="" type="checkbox"/>	<input type="checkbox"/>
Reset		Cancel		OK			

No.	Item	Description
①	Selected status	Switches between enabled and disabled state by checking the checkbox. (When checked, the setting is prohibited.) "All", "On/Off", "On", "Mode", "Temp", "Timer", and "Filter Reset" can be set to prohibited state. When "All" is checked, other checkboxes are disabled.

2-3. Schedule Setting

When the password is set at start-up, enter the password. (Refer to 3-2-5.)

- (a)
- (1) Start "Schedule Setting" by any of the following methods.
- (a) Tap the [Schedule] icon of left menu on the monitoring screen.
 - (b) Tap the [Schedule] button in Individual Setting.

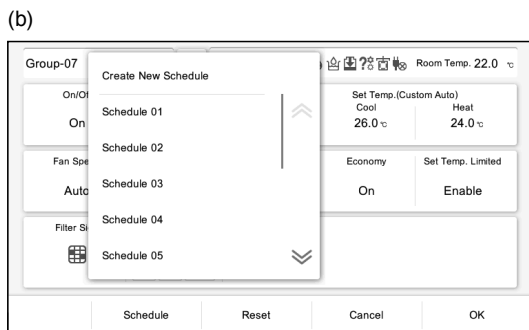
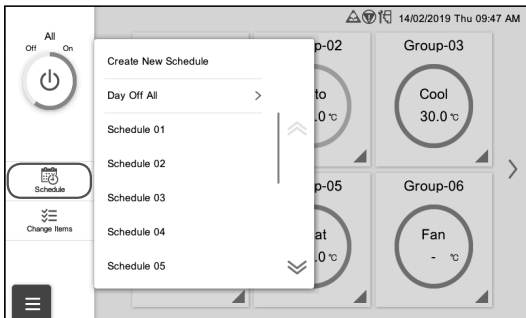

- (2) Tap [Create New Timer] or schedule name. The pop-up of schedule detail setting is displayed.

(When the schedule is not set, [Create New Timer] is displayed. If the schedule is already registered, the name is displayed.)

2-3-1. Schedule Detail Setting

Set the details of schedule.

No.	Item	Description
①	“Enable” / “Disable” display	Sets “Enable” or “Disable” for the registered schedule.
②	Schedule name	Registers the schedule name. (Max. 13 characters) Up to 20 schedules can be registered. The names can be input using keyboard and they can also be selected from the fixed form phrase. ◆ Input candidate: “Floor” / “Corridor” / “Whole” / “Hall” / “Office” / “Conf room” / “Receipt room” / “Restaurant Café” / “Lounge” / “Kitchen” / “Store” / “Stock room” / “Classroom” / “Reception” / “Entrance” / “Control room” / “Guest room” / “Room no.” / “Locker room” / “Summer set” / “Winter set” / “Weekday” / “Holiday”
③	[Delete] icon	Deletes the currently displayed schedule.
④	[Copy] icon	Newly creates the same schedule as the setting schedules at the end of the existing schedules and displays the new creation screen.
⑤	[New] icon	Creates the new schedule at the end of the existing schedules and displays the new creation screen.
⑥	Day of week	Switches the timer to be set to the day of week. “Create new timer”, “Day Off”, “Deregister”, and registered timer can be selected.
⑦	Setting timer	Displays the setting timer name. When not set, this column is blank. When Day off is set, “Day off” is displayed.
⑧	Schedule switch-over button	Switches over the displayed schedule.
⑨	Registered group	Sets the groups to be controlled. → Refer to 2-3-1-1.
⑩	[Timer Edit] button	Selects the new timer and registered timer and sets the details. → Refer to 2-3-2.

2-3-1-1. Group Selection

Set the groups to be controlled.

No.	Item	Description
①	Group	Selects the groups to be registered. When selected, the checkbox is checked.
②	R.C.G. display button	Displays the R.C.G. registered to the group.

2-3-2. Timer Detail Setting

Set the details of timer setting.

(When [Select (Delete)] is selected)

(1) Select the timer you want to delete.

Note

When you try to delete the timer setting to the schedule, "Timer cannot be deleted because it is used for the following schedule. To delete this, reset the schedule setting." is displayed.

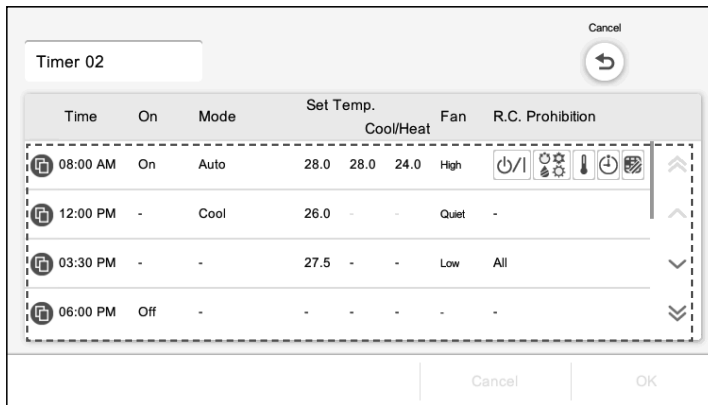

(When [Select (Copy)] is selected)

- (1) Select the timer you want to copy.
Timer is added.

No.	Item	Description
①	Timer name	Displays the timer name. The timer names are Timer 1 to 40. The smallest unregistered number at new creation is used for the timer name.
②	[Delete] icon	Deletes the currently displayed timer.
③	[Copy] icon	Copies the setting timer and creates the timer at the smallest unregistered number of 1 to 40 and shifts to the new creation screen.
④	[New] icon	Creates the new timer at the smallest unregistered number of 1 to 40 and shifts to the new creation screen.
⑤	[Select (Delete)] icon	Enters the delete selection mode.
⑥	[Select (Copy)] icon	Enters the copy selection mode.
⑦	[New] icon	Adds the list at the end of timer list. The list number is the smallest number of 1 to 10 which is not listed.
⑧	"Time"	Sets the timer time. → Refer to 2-3-2-1.
⑨	"On"/"Off"	Selects "On" or "Off". Cancels the change by selecting "Reset".
⑩	"Mode"	Selects the mode. ("Auto", "Cool", "Dry", "Fan" and "Heat". Selectable mode depends on the indoor unit) Deletes the change by selecting "Reset".
⑪	"Set Temp."	Selects the set temperature with 0.5°C (1°F) increments. Setting range: 10 to 32°C (44 to 91°F)
⑫	"Custom Auto (Cool)"*	
⑬	"Custom Auto (Heat)"*	
⑭	"Fan"	Selects fan speed. "Auto", "High", "Med-High", "Med", "Med-Low", "Low", "Quiet"
⑮	"RC Prohibition"	Sets "R.C. Prohibition". → Refer to 2-2-2-3.
⑯	Timer switch-over button	Switches over the displayed timer.
⑰	Timer list scroll button (page feed)	Displays the scroll button to switch the timer list page.
⑱	Timer list scroll button	Displays the scroll button to switch the timer list by one item.
⑲	Time▲	Rearranges the list in time order when ⑧ "Time" is tapped.

* Displays only when a unit with "Custom Auto" function is registered.

2-3-2-1. Timer Time Setting

Set the time of timer.

① 01 ✓	② :00 ✓	③ AM ✓
02	:01	PM
03	:02	
04	:03	
05	:04	
06	:05	
Cancel		OK

No.	Item	Description
①	Hour	Selects the set time (hour) of timer. When selected, the time is checked.
②	Minute	Selects the set time (minute) of timer. When selected, the time is checked.
③	“AM” / “PM”	Selects the set time (“AM” / “PM”) of timer. When selected, “AM” or “PM” is checked.

2-3-3. Batch Day Off

Set the selected day of week to Day off collectively for all schedules.

Day off: Disables the schedule operation of the setting day of week. After the setting day of week (after next day of the setting day of week), disabled schedule setting of the corresponding day of week is reset.

(Example) When Day off is set to Monday

After Day off setting is determined, Day off is enabled until next Monday. (Monday schedule is disabled.) On Tuesday, the Day off setting of Monday is reset. (The disabled schedule is reset and the setting returns to its original state.)

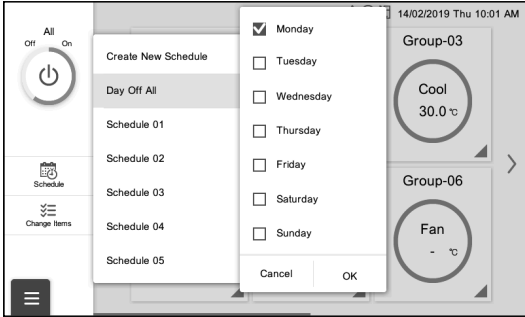

- (1) Tap the [Schedule].
- (2) Tap the [Day Off All].



- (3) Set the item and tap the [OK] button.

No.	Item	Description
①	Day of week	Selects the day of week to be set to "Day off". When selected, checkbox is checked.

3. SETTING

Set the required basic settings to use this controller. Tap the Menu button and select the menu you want to set. Perform the setting according to the pop-up.

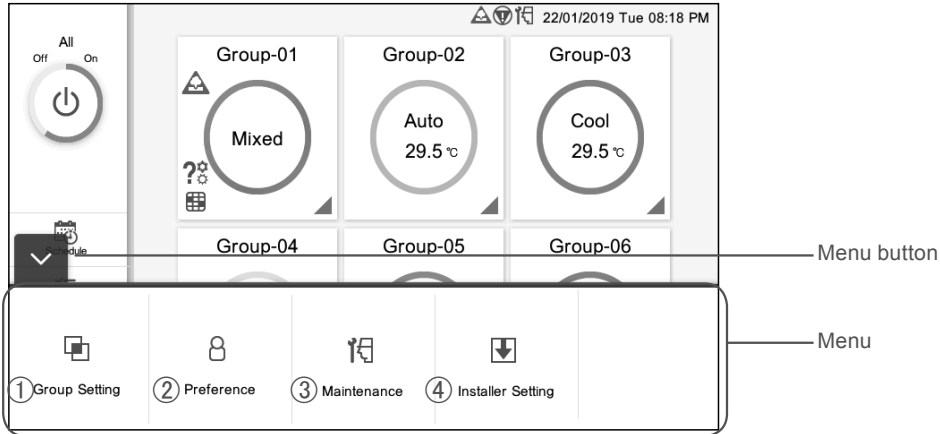

No.	Menu	Seq	Submenu	Description	Chap. No.
①	"Group Setting"	1	"Create New Group"	Sets grouping, group name operated from this controller.	<u>3-1-1</u>
②	"Preference"	1	"Backlight Setting"	Sets the backlight of screen.	<u>3-2-1</u>
		2	"Panel Calibration"	Calibrates the touch panel position.	<u>3-2-2</u>
		3	"Sound Setting"	Sets the Beep sound.	<u>3-2-3</u>
		4	"Date Setting"	Sets the date and time.	<u>3-2-4</u>
		5	"Password Setting"	Sets the passwords.	<u>3-2-5</u>
③	"Maintenance"	1	"Error History"	Displays the error history.	<u>3-3-1</u>
		2	"Display Sensor Values"	Displays the sensor values.	<u>3-3-2</u>
		3	"Version"	Displays the version information.	<u>3-3-3</u>
④	"Installer Setting"	1	"Language Setting"	Sets the languages.	<u>3-4-1</u>
		2	"Central controller Address Setting"	Sets the Central Controller address.	<u>3-4-2</u>
		3	"Indoor Unit Registration"	Registers the indoor unit.	<u>3-4-3</u>
		4	"Temp. Unit Setting"	Sets the temp. unit.	<u>3-4-4</u>
		5	"Remote Setting"	Sets the remote operation.	<u>3-4-6</u>
		6	"External Input Setting"	Sets the external input.	<u>3-4-5</u>
		7	"Mail Setting"	Performs the mail setting.	<u>3-4-7</u>
		8	"Timer Setting"	Sets the timer.	<u>3-4-8</u>
		9	"Initialization"	Performs the initialization.	<u>3-4-9</u>

3-1. Group Setting

When the password is set at start-up, enter the password. ([Refer to 3-2-5.](#))

3-1-1. Group Setting

Perform the group registration to combine the R.C.G. registered to this controller.

* One group including all indoor units (R.C.G.) registered by scanning is created at initial setting.

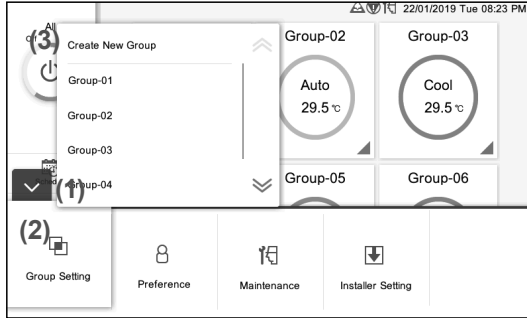

- (1) Tap the MENU button.
- (2) Tap the [Group Setting].
- (3) Tap the [Create New Group] or group name.

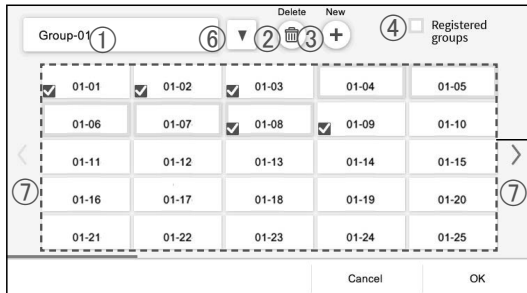

- (4) Register the group name and select the R.C.G. for each group. (The R.C.G. selected by other groups can be selected redundantly.)

- (5) Set the item and tap the [OK] button.

No.	Item	Description
①	Group name	Registers the group name. (Max. 13 characters) Up to 50 groups can be registered. The names can be input using keyboard and they can also be selected from the fixed form phrase.
②	[Delete] icon	Deletes the group. When there is no group after deletion, "There is no group to display." is displayed.
③	[New] icon	Adds the group. When the number of registered groups reaches 50, this button is disabled.
④	Already selected R.C.G.	Indicates that the R.C.G. is already selected by other groups.
⑤	R.C.G. list	When selected, checkbox is checked. Up to 100 R.C.G. can be registered for one group.
⑥	Group switch-over button	Switches over the displayed group.
⑦	R.C.G. scroll buttons	The right and left scroll buttons are displayed when R.C.G. are more than 25.

3-2. Preference

When the password is set at start-up, enter the password. ([Refer to 3-2-5.](#))

3-2-1. Backlight Setting

Arrange the LCD backlight.

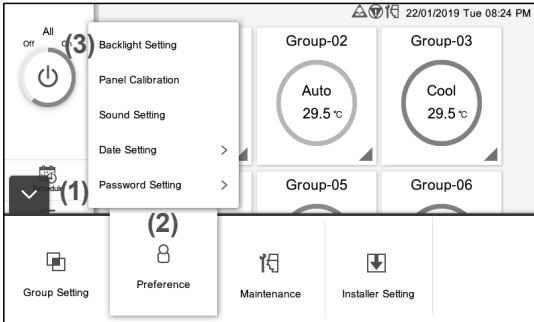

- (1) Tap the MENU button.
- (2) Tap the [Preference].
- (3) Tap the [Backlight Setting].

- (4) Set the item and tap the [OK] button.

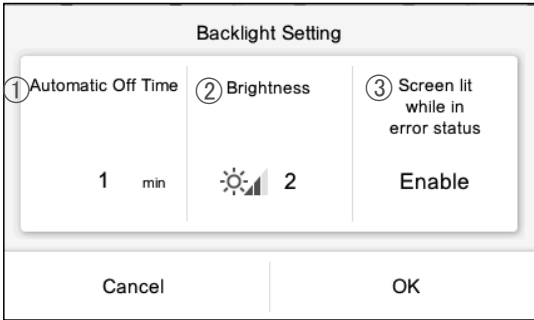

No.	Item	Description
①	"Automatic Off Time"	Sets the automatic light-off time. [1 minute to 30 minutes]
②	"Brightness"	Sets the brightness. Dark 1↔2↔3 Bright
③	"Screen lit while in error status"	Selects "Enable" or "Disable" of the setting for emergency light-on. "Enable" / "Disable"

3-2-2. Panel Calibration

Calibrate the position of LCD panel.

The buttons on the touch panel operate normally by calibration.

Only procedure (4) is displayed at initial setting.

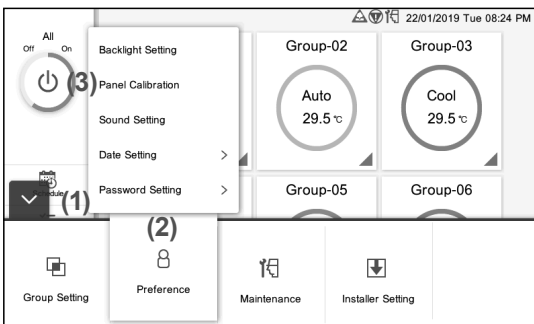

- (1) Tap the MENU button.
- (2) Tap the [Preference].
- (3) Tap the [Panel Calibration].

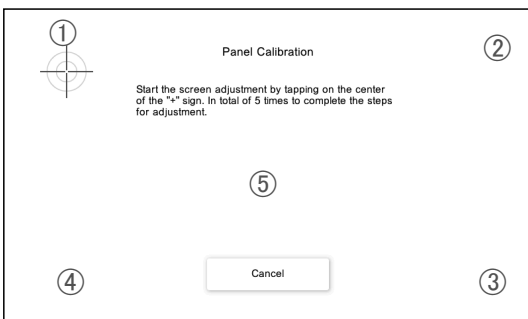

- (4) Tap the center of + marks which appear in turn at 5 places (① to ⑤).
Re-check Panel Calibration screen is displayed. Touch the 5 places again.

3-2-3. Sound Setting

Set the beep sound.

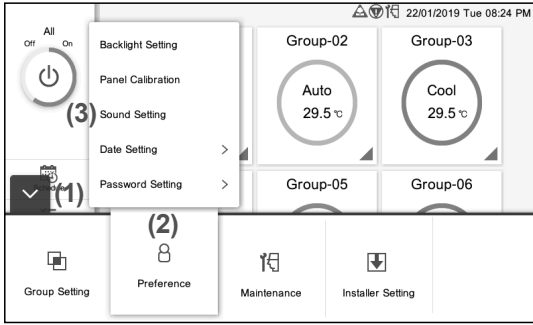

- (1) Tap the MENU button.
- (2) Tap the [Preference].
- (3) Tap the [Sound Setting].

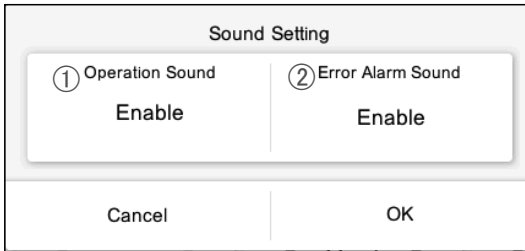

- (4) Set the item and tap the [OK] button.

No.	Item	Description
①	“Operation Sound”	Sets the beep sound during operation. “Enable” / “Disable”
②	“Error Alarm Sound”	Sets the beep sound on error. “Enable” / “Disable”

3-2-4. Date Setting

Perform the setting for date and time.

3-2-4-1 is displayed at initial setting.

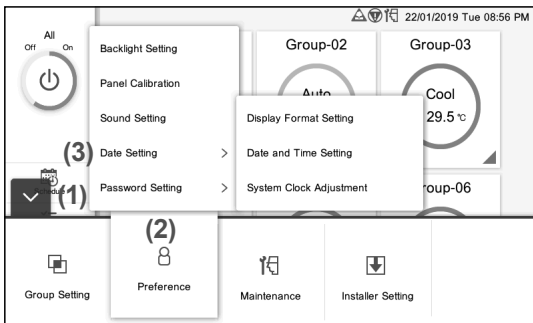

- (1) Tap the MENU button.
- (2) Tap the [Preference].
- (3) Tap the [Date Setting].

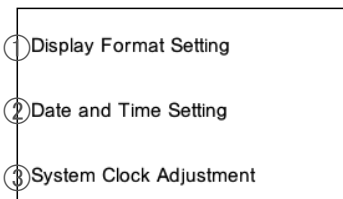

- (4) Select the process from the submenu below.

No.	Item	Description
①	“Display Format Setting”	Sets the display format of date and time. → Refer to 3-2-4-1.
②	“Date and Time Setting”	Sets the date and time of the system. → Refer to 3-2-4-2.
③	“System Clock Adjustment”	Performs the system clock adjustment. → Refer to 3-2-4-3.

3-2-4-1. Display Format Setting

Set the display format of date and time.

(1) Set the item and tap the [OK] button.

No.	Item	Description
①	"Date Format"	Selects from the followings. "Day/Month/Year" "Month/Day/Year" "Year/Month/Day"
②	"Time Format"	Selects from the followings. 12:00 - 11:59 AM/PM 00:00 - 11:59 AM/PM 00:00 - 23:59

3-2-4-2. Date and Time Setting

Set the date and time of the system.

(1) Set the item and tap the [OK] button.

No.	Item	Description
①	"Date"	Sets the system date. Tap the year, month, and day respectively. (*)
②	"Time"	Sets the system time. Tap the hour and minute respectively. (*)
③	"Summer Time Setting"	When summer time system is used, tap the [Enable].
④	"Time Zone Setting"	In the displayed list as shown at the left figure, set the time zone of the area where this controller is installed.

* "Date" and "Time" are displayed in the format set at **3-2-4-1 Display Format Setting**.

3-2-4-3. System Clock Adjustment

Perform the system clock adjustment.

(1) Set the item and tap the [OK] button.

No.	Item	Description
①	"Master/Slave"	Selects from the following 3 types. "Master" / "Slave" / "Disable"
②	"Current time transmission"	Transfers the current time.
③	"Clock Adjustment Schedule"	Selects the clock adjustment schedule from "Daily" or "Weekly".
④	Day	Selects the day of week when "Weekly" is selected. "Sun" / "Mon" / "Tue" / "Wed" / "Thu" / "Fri" / "Sat"
⑤	Time	Selects the time for clock adjustment.

3-2-5. Password Setting

Password can be set at program start-up to maintain confidentiality. [Initial value: 0000]

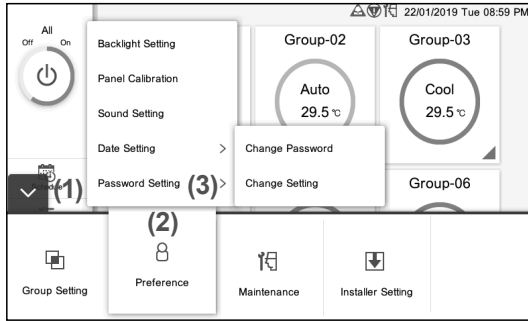

- (1) Tap the MENU button.
- (2) Tap the [Preference].
- (3) Tap the [Password Setting].

Functions targeted by password setting

"Group setting"
"Preference"
"Maintenance"
"Installer setting"
"Schedule setting"
"Operation setting"

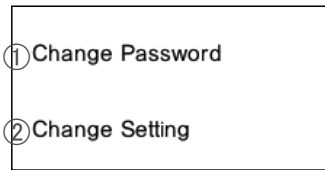

- (4) Select the process from the submenu below.

No.	Item	Description
①	"Change Password"	Changes the password. [Initial value: 0000] →Refer to 3-2-5-1.
②	"Change Setting"	Changes the password setting. →Refer to 3-2-5-2.

3-2-5-1. Change Password

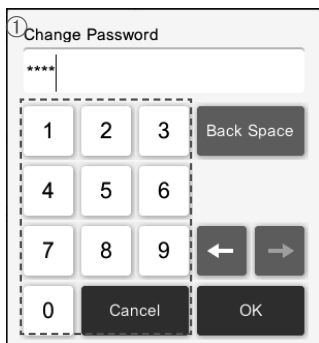

- (1) Set the item and tap the [OK] button.

No.	Item	Description
①	"Change Password"	Sets 4 to 8 digits password when it is set. (Enter the password twice.)

3-2-5-2. Password Setting

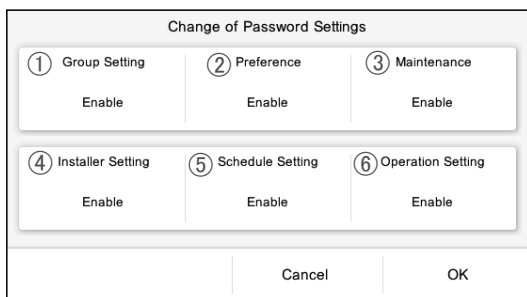

- (1) Set the item and tap the [OK] button.
[Initial value: All "Enable"]

No.	Item	Description
①	"Group Setting"	"Enable" / "Disable"
②	"Preference"	"Enable" / "Disable"
③	"Maintenance"	"Enable" / "Disable"
④	"Installer Setting"	"Enable" / "Disable"
⑤	"Schedule Setting"	"Enable" / "Disable"
⑥	"Operation Setting"	"Enable" / "Disable"

3-3. Maintenance

Maintenance menus are available.

When the password is set at start-up, enter the password. (Refer to 3-2-5.)

3-3-1. Error History

Error occurrence history can be checked.

[Up to 200 errors can be displayed at "Error History". Error histories that exceed 200 are deleted from oldest history.]

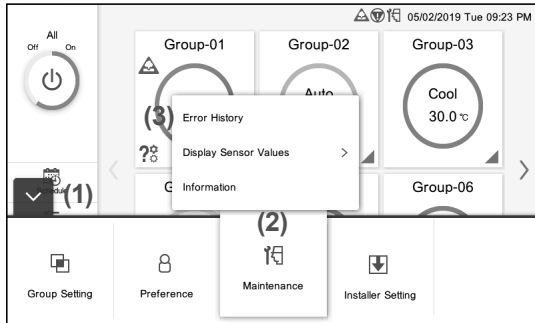

- (1) Tap the MENU button.
- (2) Tap the [Maintenance].
- (3) Tap the [Error History].

The screenshot shows a table titled 'Error History' with 10 rows of data. Numbered callouts (1-7) point to specific elements: (1) the table header, (2) the Date/Time column, (3) the Name column, (4) the Address column, (5) the Model Name column, (6) the Error Code column, and (7) the Erase All button at the bottom left.

No.	Date/Time	Name	Address	Model Name	Error Code
001	2019/1/22 13:51	00-01	00-01-01	ABHA18LBTH	12.F
002	2019/1/22 13:49	01-01	01-01-02	ABHA18LBTH	32.1
003	2019/1/22 13:45	Outdoor Unit	01-00	AJH040LCLAH	92.1
004	2019/1/22 13:40	Central Controller	200-03	UTY-DCGYZ1	164
005	2019/1/21 18:00	01-03	01-03-11	ABHA18LBTH	5U.1
006	2019/1/21 17:35	00-02	00-02-03	ABHA18LBTH	5U.1
007	2019/1/21 13:20	00-01	00-01-01	ABHA18LBTH	5U.1
008	2019/1/21 12:00	01-01	01-01-02	ABHA18LBTH	32.1
009	2019/1/20 20:40	00-04	00-04-01	ABHA18LBTH	32.3
010	2019/1/20 17:32	00-01	00-01-03	ABHA18LBTH	12.2

(4) Error histories are displayed.

- ① "No.": Displayed in descending order of occurrence date and date.
- ② "Date/Time": Error occurrence date and time
- ③ "Name": Units where an error occurs (One of "Indoor Unit" • R.C.G. name, "Outdoor Unit", and "Central Controller")
- ④ "Address": Address of the units where an error occurs
 "Indoor Unit": Refrigerant system No. – Unit No.
 – R.C.G. internal identification No.
 "Outdoor Unit": Refrigerant system No. - Unit No.
 "Central Controller": Address of this controller
- ⑤ "Model name": One of "Indoor Unit" (R.C.G. name), "Outdoor Unit", and "Central Controller"
- ⑥ "Error code"
- ⑦ [Erase All]: Erases all error histories.

3-3-2. Display Sensor Values

Monitor and display the sensor values of indoor unit and outdoor unit.

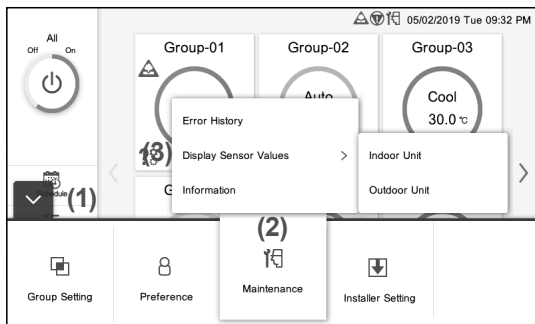

- (1) Tap the MENU button.
- (2) Tap the [Maintenance].
- (3) Tap the [Display Sensor Values].

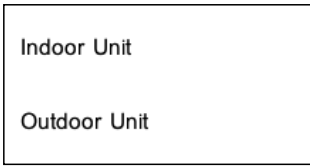

- (4) Select the unit whose sensor value is checked.
 “Indoor Unit” / “Outdoor Unit”

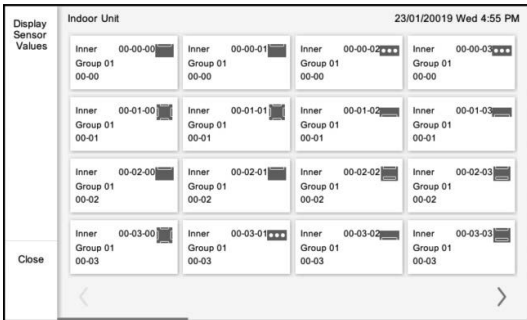

- (5) The screen of selected unit is displayed.

(Tap the [Close] button to exit.)

For “Indoor Unit”

First line: Refrigerant system No. – Unit No. – Remote controller address No.

Second line: Group name

Third line: R.C.G. address

For “Outdoor Unit”

Refrigerant system No. – Unit No.

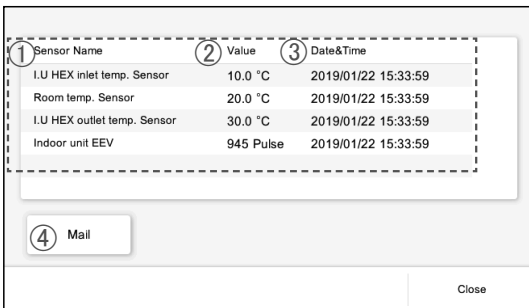

- (6) Sensor values of the tapped unit are displayed.

① “Sensor Name”

② “Value”

③ “Date&Time”

④ [Mail]:When the [Mail] button is tapped, “Send” screen is displayed and sensor value information is sent to the set mail address.→**Refer to 3-4-7.**

3-3-3. Information

The version of this software and MAC Address are displayed.

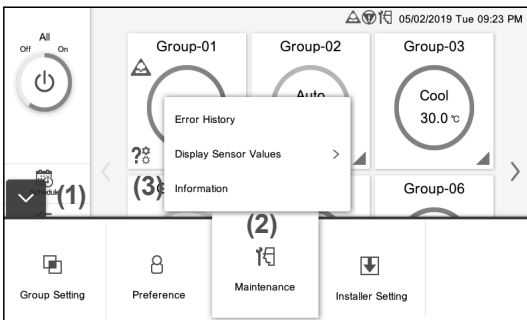

- (1) Tap the MENU button.

(2) Tap the [Maintenance].

(3) Tap the [Information].

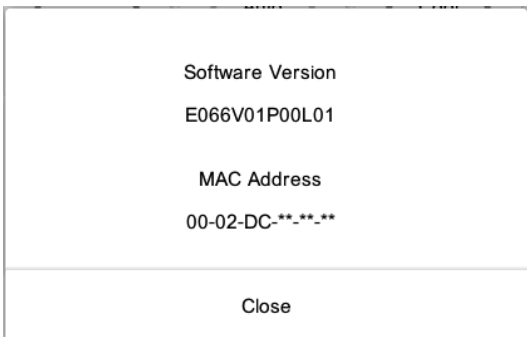

- (4) The version of this software and MAC Address are displayed.

3-4. Installer Setting

When the password is set at start-up, enter the password. ([Refer to 3-2-5.](#))

3-4-1. Language Setting

Select the languages to be used on this controller.

Only procedure (4) is displayed at initial setting.

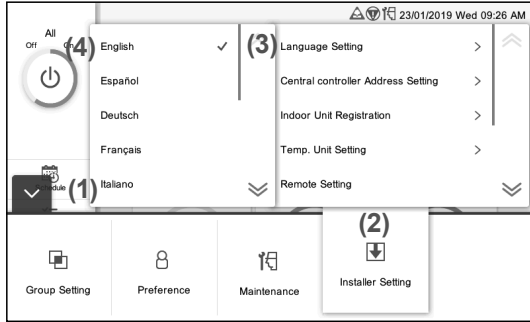

- (1) Tap the MENU button.
- (2) Tap the [Installer Setting].
- (3) Tap the [Language Setting].
- (4) Tap the language.

Language list
English
Español
Deutsch
Français
Italiano
Русский
Português
Türkçe
Język polski
Ελληνικά
Dutch
中文

3-4-2. Central Controller Address Setting

Set the address of this controller.

Only procedure (4) is displayed at initial setting.

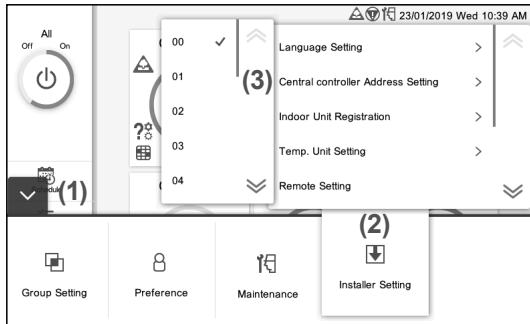

- (1) Tap the MENU button.
- (2) Tap the [Installer Setting].
- (3) Tap the [Central Controller Address Setting].

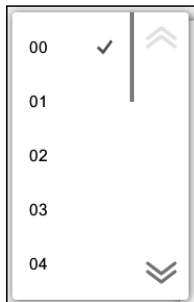

- (4) Tap the address list "00" – "15".

Note

When 2 or more controllers* are installed in the system, set the address numbers so that the controller addresses (numbers) are not duplicated.

* Touch Panel Controller, Network Convertor(Group Remote Controller).

3-4-3. Indoor Unit Registration

Register the indoor unit to be controlled by this controller.

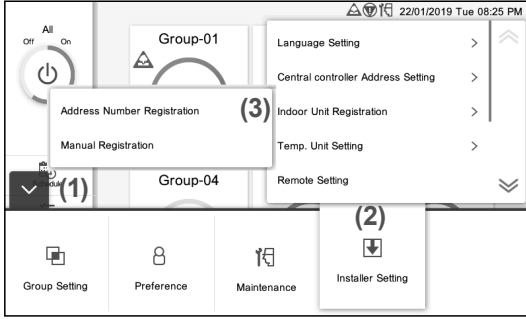

- (1) Tap the MENU button.
- (2) Tap the [Installer Setting].
- (3) Tap the [Indoor Unit Registration].

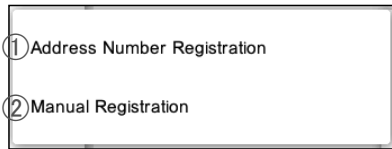

- (4) Select the process from the submenu below.

No.	Item	Description
①	“Address Number Registration”	Deletes the currently registered indoor units and registers the indoor units in ascending order of address. → Refer to 3-4-3-1.
②	“Manual Registration”	Registers the indoor units manually without deleting the currently registered indoor units. → Refer to 3-4-3-2.

Note

When “Address Number Registration” is performed, the registered address setting will be deleted. In the case of manual registration, the registered address is not deleted.

3-4-3-1. Address Number Registration

Register the indoor units in the specified refrigerant system range.

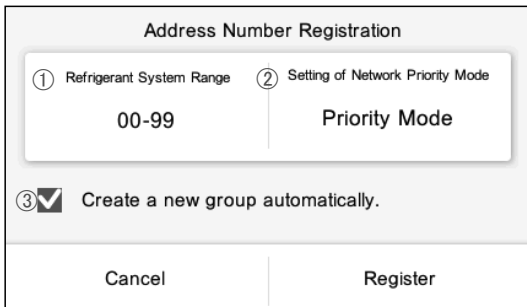

- (1) Set the item and tap the [Register] button.

No.	Item	Description
①	“Refrigerant System Range”	Inputs “Refrigerant System Range” to be registered for indoor unit. [Initial value: 00-99]
②	“Setting of Network Priority Mode”	Selects from “Priority Mode” or “Normal”. “Priority Mode”: Performs the scan by stopping the system.
③	(Checkbox) “Create a new group automatically.”	<ul style="list-style-type: none"> • When the checkbox is checked, the group of only the newly added indoor unit (R.C.G.) is created. When not checked, the newly added indoor unit does not belong to the group. • Created group name: Group **

* When some users operate remotely, the left message is displayed. When the [OK] button is tapped, all connections will be disconnected by this operation.

- (2) Register the indoor unit. → **Refer to 3-4-3-3.**

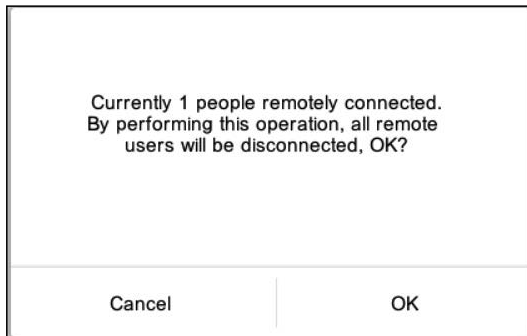

3-4-3-2. Manual Registration

Register the indoor unit manually.

The dialog box is titled "Manual Registration". It contains two input fields: "① Refrigerant Address" with the value "00" and "② Indoor Unit Address" with the value "00". Below these fields is a checkbox labeled "③ Create a new group automatically." which is checked. At the bottom, there are two buttons: "Cancel" and "Register".

(1) Set the item and tap the [Register] button.

No.	Item	Description
①	"Refrigerant Address"	Inputs "Refrigerant Address" to be registered for indoor unit. [Initial value: 00]
②	"Indoor Unit Address"	Inputs "Indoor Unit Address" to be registered. [Initial value: 00]
③	(Checkbox) "Create a new group automatically."	<ul style="list-style-type: none"> When the checkbox is checked, the group of only the newly added indoor unit (R.C.G.) is created. When not checked, the newly added indoor unit does not belong to the group. Created group name: Group ** (** : Smallest unregistered number of 1 to 50)

(2) Register the indoor unit. → **Refer to 3-4-3-3.**

3-4-3-3. Registration

For registration, Confirmation mode and Delete mode are available.

• Confirmation mode

The dialog box is titled "Confirmation of Registration Indoor units". It shows a grid of indoor unit addresses from 00-00 to 00-24. A "Select (Delete)" button is visible in the top right corner. Below the grid are "Cancel" and "OK" buttons.

The dialog box is titled "Registered Address". It displays a list of indoor unit addresses from 00-00-00 to 00-00-15. A "Close" button is located at the bottom.

(1) When R.C.G. is tapped, the indoor unit addresses belonging to R.C.G. are displayed.

• Delete mode

The dialog box is titled "Confirmation of Registration Indoor units" with the subtitle "To delete it, press 'Delete' button." It shows a grid of indoor unit addresses from 00-00 to 00-24. A "Delete" button is visible in the top right corner. Some addresses (00-12, 00-13, 00-18, 00-19, 00-22) have checkboxes checked. Below the grid are "Cancel" and "OK" buttons.

(2) There is a [Select (Delete)] button on the Confirmation of Registration Indoor units screen. When [Select (Delete)] button is tapped, [Delete] button appears and the screen moves to the Delete mode. The registered indoor unit can be deleted by checking the R.C.G.. When R.C.G. is tapped, the checkbox is checked and when the [Delete] button is tapped, the checked R.C.G. can be deleted.

Note

For the Delete mode, even if R.C.G. button is tapped, indoor unit address is not displayed.

3-4-4. Temp. Unit Setting

Set the temp. unit to be used by this controller.

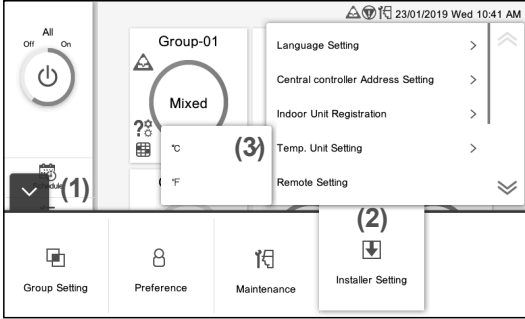

- (1) Tap the MENU button.
- (2) Tap the [Installer Setting].
- (3) Tap the [Temp. Unit Setting].

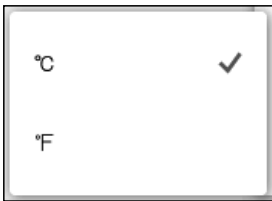

- (4) Tap the temp. unit [°C] or [°F].

3-4-5. Remote Setting

Perform the network setting for remote control.

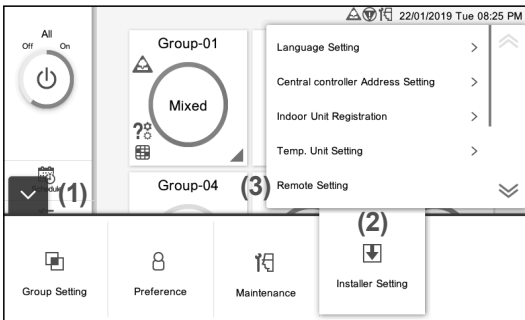

- (1) Tap the MENU button.
- (2) Tap the [Installer Setting].
- (3) Tap the [Remote Setting].

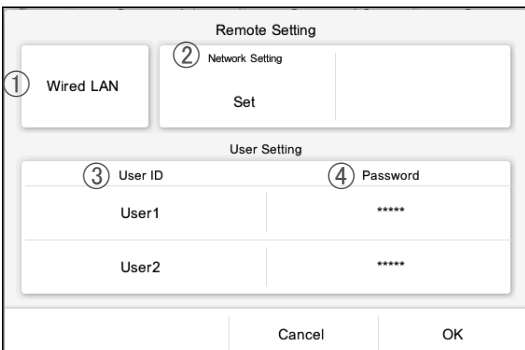

- (4) Set the item and tap the [OK] button.

No.	Item	Description
①	“Wired LAN”	Selects whether LAN connection is used or not.→ Refer to 3-4-5-1.
②	“Network Setting”	Sets the network when LAN connection is used.→ Refer to 3-4-5-2.
③	“User ID” (*)	Sets the user ID (Max. 20 characters) for remote login when LAN connection is used.
④	“Password” (*)	Sets the user password (Max. 20 characters) for remote login when LAN connection is used.

(*) Max. 20 alphanumeric characters and symbols

3-4-5-1. LAN Setting

Select whether LAN connection is used or not.

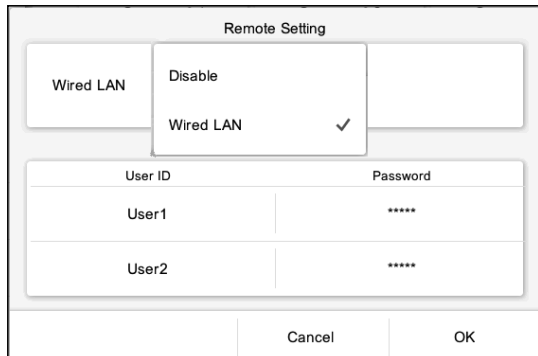

(1) Set the item and tap the [OK] button.

No.	Item	Description
①	LAN Setting	Selects from the followings. <ul style="list-style-type: none"> When LAN connection is not used, select "Disable". When LAN connection is used, select "Wired LAN".

3-4-5-2. Network Setting

When "Wired LAN" is selected at LAN setting, set the network.

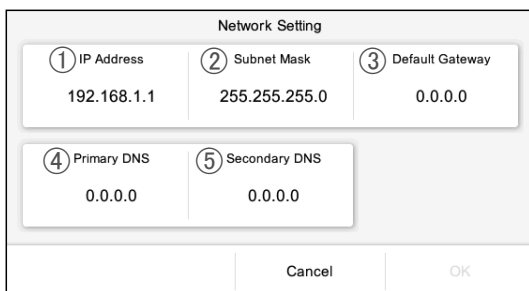

(1) Set the item and tap the [OK] button.

[Initial value: Addresses are set as shown in the left figure.]

No.	Item	Description
①	"IP Address" (*)	Sets "IP address" of remote terminal.
②	"Subnet Mask" (*)	Sets "Subnet mask" of remote terminal.
③	"Default Gateway" (*)	Sets "Default Gateway" of remote terminal.
④	"Primary DNS" (*)	Inputs "Primary DNS" (Domain Network Service) of remote terminal.
⑤	"Secondary DNS" (*)	Inputs "Secondary DNS" (Domain Network Service) of remote terminal.

(*) [***.***.***.***] (Input 0 to 255 at "****".)

3-4-6. External Input Setting

Perform the external input setting.

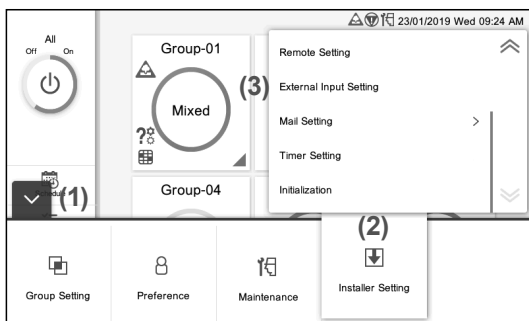

(1) Tap the MENU button.

(2) Tap the [Installer Setting].

(3) Tap the [External Input Setting].

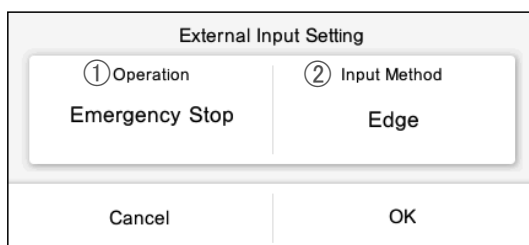

(4) Set the item and tap the [OK] button.

No.	Item	Description
①	"Operation"	Selects "Operation" for external input. "Emergency Stop", "All On/Off", "Not Used"
②	"Input Method"	Selects "Input method". "Edge", "Pulse"

3-4-7. Mail Setting

Sets the mail address destination when “Error notification” or “Room temperature notification” is sent.

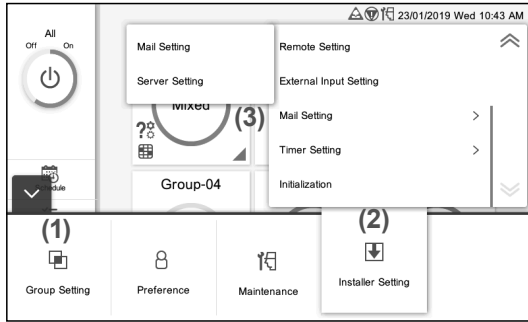

- (1) Tap the MENU button.
- (2) Tap the [Installer Setting].
- (3) Tap the [Mail Setting].

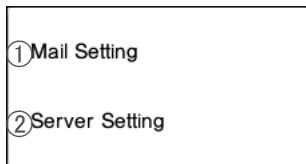

- (4) Select the setting function.

No.	Item	Description
①	“Mail Setting”	Performs the mail account setting, etc. →Refer to 3-4-7-1.
②	“Server Setting”	Performs the mail server connection setting.→Refer to 3-4-7-2.

* After the Server Setting is performed, perform the Mail setting.

3-4-7-1. Mail Setting

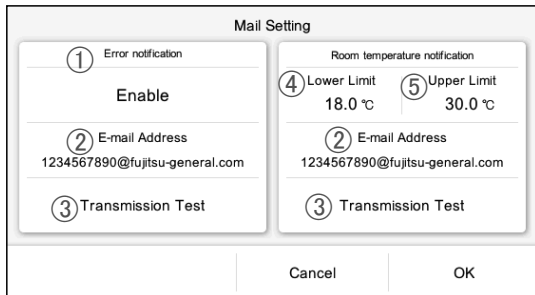

- (1) Set the item and tap the [OK] button.

No.	Item	Description
①	“Error notification”	Sets “Enable” or “Disable” of mail notification when an error occurs.
②	“Email Address”	Sets the mail address destination when “Error notification” or “Room temperature notification” is sent.
③	“Transmission Test”	Performs “Transmission test” to send the notification mail. Transmission result display: “Failed sending mail.” / “Mail sent.”
④	“Room temperature notification” (“Lower Limit”)	Sets the room temperature lower limit for sending a mail. “Lower limit”: -15.5°C
⑤	“Room temperature notification” (“Upper Limit”)	Sets the room temperature upper limit for sending a mail. “Upper limit”: 63.5°C

3-4-7-2. Server Setting

(1) Set the item and tap the [OK] button.

No.	Item	Description
①	“Sender Email Address”	Inputs “Sender Email Address”.
②	“Outgoing Email Server Address”	Inputs “Outgoing Email Server Address”.
③	“Port”	Inputs “Port”.
④	“Account Name”	Inputs “Account name”. (Max. 50 characters)
⑤	“Password”	Inputs “Password”. (Max. 12 characters)
⑥	“SSL”	Selects “SSL”. “None” / “SMTP over SSL” / “STASTTLS”

3-4-8. Timer Setting

Set the timer which stops the operation automatically to prevent you from forgetting to turn off.

- (1) Tap the MENU button.
- (2) Tap the [Installer Setting].
- (3) Tap the [Timer Setting].

(4) Set the item and tap the [OK] button.

No.	Item	Description
①	“Auto Off Timer”	Sets “Enable” or “Disable” of the timer. When “Enable” is selected, ② to ⑤ are enabled.
②	“Operation Stop Time”	Sets “Operation Stop Time” in 10-minutes unit. [30-240 min]
③	“Time Range”	Selects “Time Range”. “Range Spec.” / “Continuous”
④	“Start Time”	Sets “Start time”. When “Range Spec.” is selected, this item is enabled.
⑤	“End Time”	Sets “End time”. When “Range Spec.” is selected, this item is enabled.
⑥	“Registered groups”	Sets the groups to be controlled. →Refer to 2-3-1-1.

(When "Operation Stop Time" is selected)



(When "Start Time" and "End Time" are selected)



3-4-9. Initialization

Perform the Initialization of this controller.

All registered contents will be deleted and returned to the factory default setting by this function.

Please use this function with great caution.

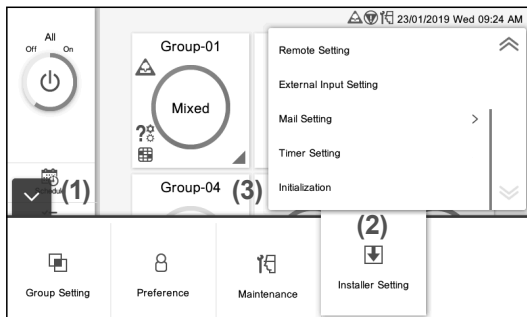

- (1) Tap the MENU button.
- (2) Tap the [Installer Setting].
- (3) Tap the [Initialization].

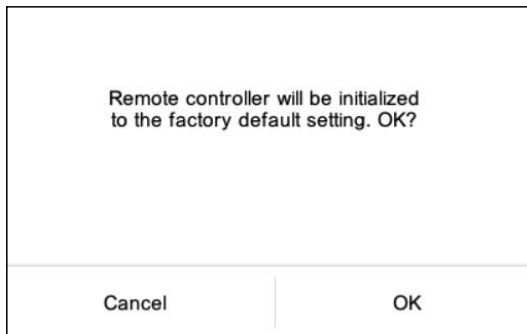

- (4) When initializing this controller, tap the [OK] button. Wait for a while without turning off the power. After the initial setting screen appears, set according to the wizard. → Refer to 1-5.

4. REMOTE CONTROL OPERATION

[Usage Condition]

Smartphone or Tablet PC	Supported OS: • Android OS • iOS	Please check the latest supported OS version at Google play or App store.
	Recommended browser version	IE: 11 or later, Chrome: 63 or later, Safari: 11 or later

Android and Google Play are registered trademarks of Google Inc.

App store is a service mark of Apple Inc., registered in the U.S. and other countries.

IOS is a trademark or registered trademark of Cisco in the U.S. and other countries and is used under license.

For information on this controller, please refer to the following web site.

www.fujitsu-general.com/global/support/

[Usage Precaution]

- When you use this product, it will become possible to operate the air conditioner from locations where you cannot see it directly. This means that people in the room may be exposed to the unintended operation of the air conditioner. Check the condition of the room before using this product.
- **Be sure to check on a regular basis that the power supply to the air conditioner is securely connected, and that dust has not built up in the surrounding area. It may cause heating, or fire.**
- **Be sure to check in advance that there are no malfunctions of the air conditioner.**
- **Be sure that the airflow from the air conditioner will not cause any adverse effects.**
Objects may fall down causing personal injury, fire, or damage to property.
- **If you know that there are people in the vicinity of the air conditioner, inform them in advance that you will be operating and stopping it from a distant location.**
Sudden operation or stopping of the air conditioner may surprise a person and cause the person to fall down or tumble if the person is on a stand.
Furthermore, rapid changes in the room temperature may cause deterioration in a person's physical condition. Do not use this product when there are people in the room who are not able to control the temperature by themselves.
(For example, infants, children, those with physical disabilities, elderly or sick persons.)
- **Fully understand the reserved timer settings and other operations before using this product.**
Unexpected operation or stopping of the air conditioner may cause deterioration in a person's physical condition or an adverse effect on animals or plants.
- **Frequently check the settings and operating situation of the air conditioner when using this product from a distant location.**
Rapid changes in the room temperature may cause deterioration in a person's physical condition or an adverse effect on animals or plants.

4-1. Remote Operation Setting

- (1) Start a browser and input the web page address in the address field.
(Web page address)
[https:// \[Central Controller IP address\]:\[port\]/index.html](https://[Central Controller IP address]:[port]/index.html)
- (2) Input "Login ID" and "Password". Select "Language" and tap the [login] button.
(Input "Login ID" and "Password" which are set on the remote setting screen.)
- (3) Monitoring screen for remote control is displayed.

4-2. Monitor

[Tablet Screen]

4-2-1. Monitoring screen

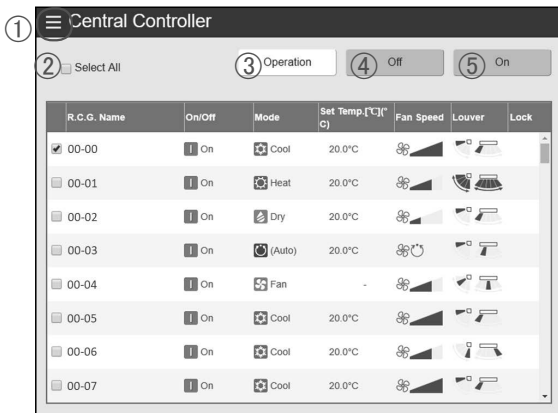

- (1) Check the checkbox of R.C.G. to be changed for the setting.

No.	Item	Description
①	Menu button	Selects the process. • Monitor → Refer to 4-2. • Change Password → Refer to 4-3. • Unit display order → Refer to 4-4. • Environment Setting → Refer to 4-5.
②	"Select All"	Selects (Checks) all R.C.G..
③	[Operation]	Sets the operation. → Refer to 4-2-2.
④	[Off]	Sets the selected R.C.G. to Off.
⑤	[On]	Sets the selected R.C.G. to On.

[Smartphone Screen]

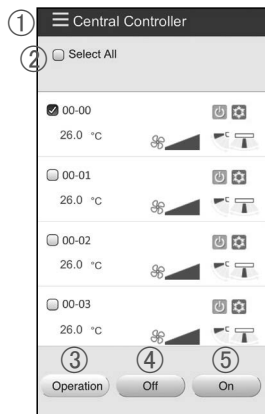

4-2-2. Operation

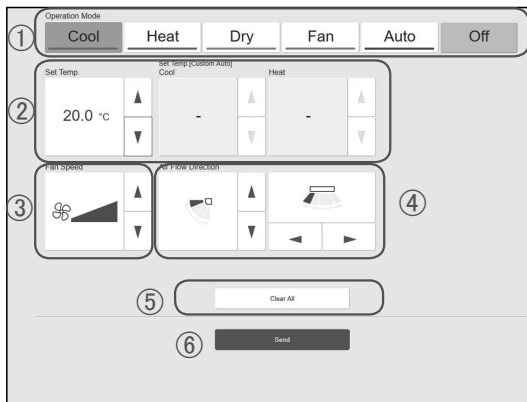

(1) Set the item and tap the [Send] button.

No.	Item	Description
①	“Operation mode”	Selects one of “Cool”, “Heat”, “Dry”, “Fan”, “Auto”, and “Off”. (Selectable mode depends on the indoor unit)
②	“Set temp.”	Selects the “Set Temp.” with 0.5°C (1°F) in unit. (except when “Fan” or “Off” is selected)
	* “Set temp. [Custom Auto]”	Selects the “Set Temp.” during “Cool” operation and the “Set Temp.” during “Heat” operation when operation mode is “Custom Auto”. (Applied indoor unit and non-applied outdoor unit cannot be mixed.)
③	“Fan Speed”	Sets the air volume.
④	“Air Flow Direction”	Sets the air flow direction for vertical and horizontal directions.
⑤	[Clear All] button	Resets the screen and returns to the original status.
⑥	[Send] button	Sends the setting contents to the Central Controller.

4-3. Change Password

Set the password.

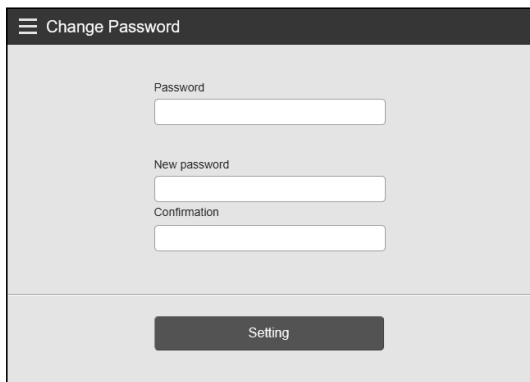

(1) Set the password.

Input the following items and tap the [Setting] button.

- ① Password
- ② New password
- ③ New password (Confirmation)

4-4. Unit display order

Change the display order of R.C.G..

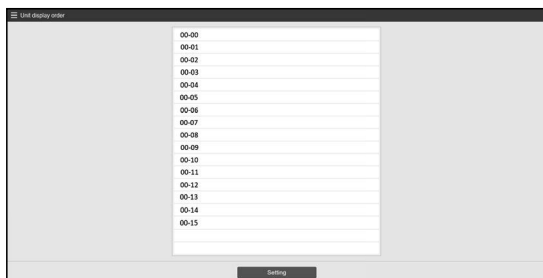

(1) Sort the unit and tap the [Setting] button.

4-5. Environment Setting

Set the temp. unit for this system display.

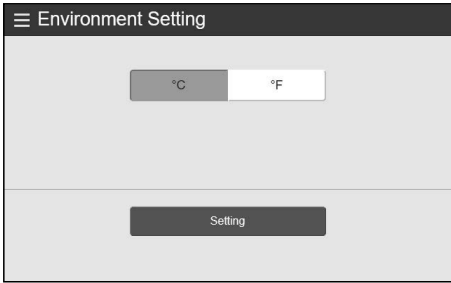

(1) Select [°C] or [°F] of temp. unit and tap it.

5. TROUBLESHOOTING

5-1. Error

When special state occurs in the system, such as when the error or refrigerant leakage occurs in this controller, error contents are displayed at the forefront of the screen. The mail of error contents is sent to the registered mail address for error notification at the same time.

■ Error

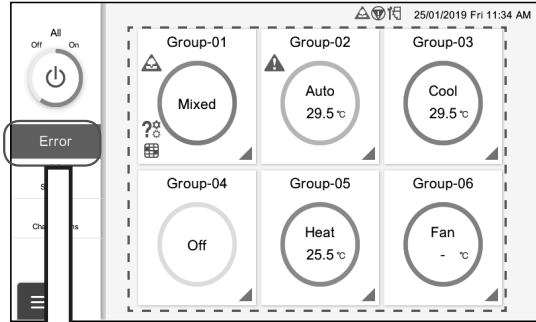

Error display (Indoor unit)

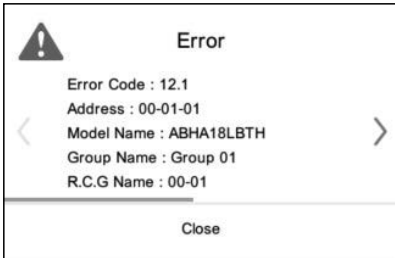

Error display (Outdoor unit)

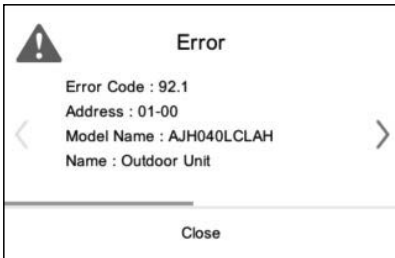

Error display (Controller)

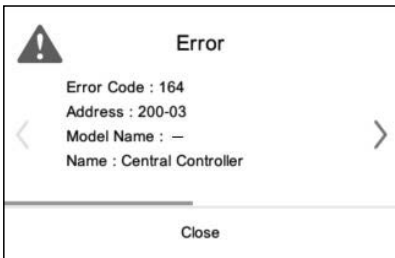

When the [Error] button is tapped, the error information (Error message or Refrigerant leakage) is displayed on the screen. Contact the service department as necessary.

Error information is displayed. Confirm the error location. (For the error code concerning indoor unit and outdoor unit, refer to the manual of each unit.)

(Indoor unit)

- “Error code”
- “Address”
- “Model Name”
- “Group Name”
- “R.C.G Name”

(Outdoor unit)

- “Error code”
- “Address”
- “Model Name”
- “Name” (Fixed to “Outdoor Unit”)

(Controller)

- “Error code”
- “Address”
- “Model Name” (Fixed to “—”)
- “Name” (Fixed to “Central Controller”)

■ Refrigerant leakage

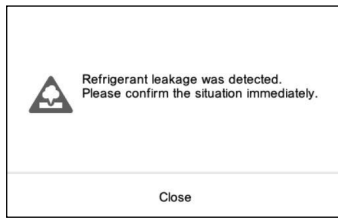

When refrigerant leakage is detected, the following message is displayed at the forefront of the screen. Confirm the error location.

“Refrigerant leakage was detected. Please confirm the situation immediately.”

5-2. Emergency Stop

The pop-up of emergency stop is displayed in any of the following cases.

5-2-1. When a signal is received from external input

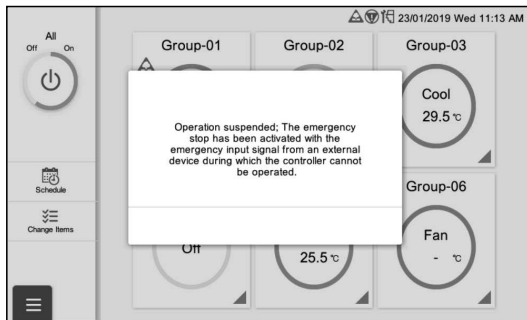

- When a signal is received from external input, the following message is displayed at the forefront of the screen.
“Operation suspended; The emergency stop has been activated with the emergency input signal from an external device during which the controller cannot be operated.”
- When the release notification is received from external input, release “Emergency Stop”.

5-2-2. When a signal is received from VRF system

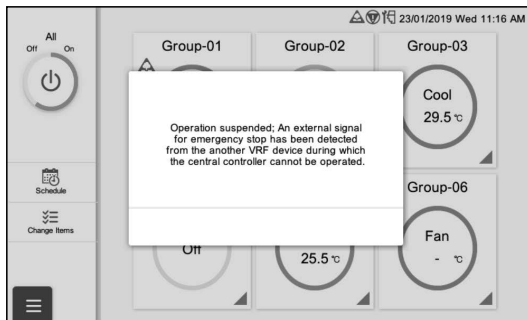

- When a signal is received from VRF system, the following message is displayed at the forefront of the screen.
“Operation suspended; An external signal for emergency stop has been detected from the another VRF device during which the central controller cannot be operated.”
- When the release notification is received from VRF system, release “Emergency Stop”.

5-3. Error Code

For the details or the indoor unit or outdoor unit error when checking the error contents, refer to the error codes in each installation manual.

Error code	Contents
161	Communication PCB connection error
164	Peripheral device network communication error
C21	Communication PCB error

6. SPECIFICATIONS

Model name		UTY-DCGYZ1, UTY-DCGGZ1
Power source voltage	V	1 ϕ AC100 - 240
Power source frequency	Hz	50 / 60
Power consumption	W	7
Display		Color TFT LCD, 7.0 inch WVGA
External interface		Transmission line
		External input
		External output
		Wired LAN (100BASE-TX)
Usage temperature range	$^{\circ}$ C ($^{\circ}$ F)	0 to 40 (32 to 104)
Usage humidity range	%	0 to 85 (no condensation)
Storage temperature range	$^{\circ}$ C ($^{\circ}$ F)	-20 to 70 (-4 to 158)
Storage humidity range	%	0 to 85 (no condensation)
Dimensions (H×W×D)	mm (in.)	134.6×216.2×37.9 (5-5/16×8-1/2×1-1/2)
Weight	g (oz.)	800 (28.2)

* The liquid crystal panel is manufactured using high precision technology, but there may be 0.01% or less mixing pixels or continuously lighted pixels. This is not a trouble.

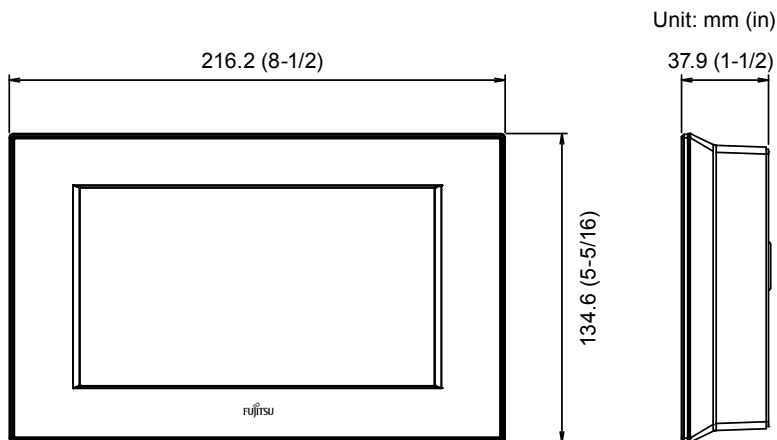

FUJITSU GENERAL LIMITED

3-3-17, Suenaga, Takatsu-ku, Kawasaki 213-8502, Japan