

AIR CONDITIONER
CASSETTE TYPE

OPERATING MANUAL
BEDIENUNGSANLEITUNG
MODE D'EMPLOI
MANUAL DE FUNCIONAMIENTO
MANUALE DI ISTRUZIONI
ΕΓΧΕΙΡΙΔΙΟ ΛΕΙΤΟΥΡΓΙΑΣ
MANUAL DE FUNCIONAMIENTO
РУКОВОДСТВО ПО ЭКСПЛУАТАЦИИ
KULLANIM KİTABI
使用説明書

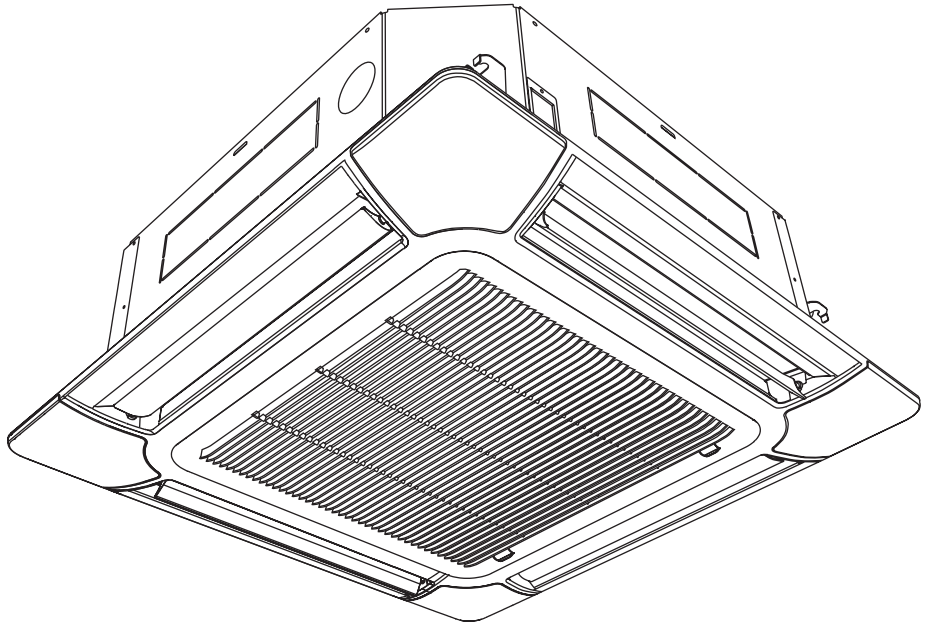

KEEP THIS MANUAL FOR FUTURE REFERENCE
BEWAHREN SIE DIESES HANDBUCH ZUM SPÄTEREN NACHSCHLAGEN AUF
CONSERVEZ CE MANUEL POUR RÉFÉRENCE ULTÉRIEURE
CONSERVE ESTE MANUAL PARA SU FUTURA CONSULTA
CONSERVARE IL PRESENTE MANUALE PER FUTURE CONSULTAZIONI
ΦΥΛΑΞΤΕ ΤΟ ΕΓΧΕΙΡΙΔΙΟ ΓΙΑ ΜΕΛΛΟΝΤΙΚΗ ΑΝΑΦΟΡΑ
GUARDE ESTE MANUAL PARA CONSULTA FUTURA
РУКОВОДСТВО ДЛЯ СПРАВОК В БУДУЩЕМ
BU KILAVUZU, DAHA SONRA BAŞVURMAK ÜZERE SAKLAYIN
請保存本說明書以供日後參考

PART NO. 9378589100

English

Deutsch

Français

Español

Italiano

Ελληνικά

Português

Русский

Türkçe

中國語



CONTENTS

SAFETY PRECAUTIONS.....	2	ADJUSTING THE DIRECTION OF AIR	
FEATURES AND FUNCTIONS	3	CIRCULATION	13
NAME OF PARTS	4	SWING OPERATION	14
PREPARATORY OPERATION	6	ECONOMY OPERATION	14
OPERATION.....	7	CLEANING AND CARE.....	15
TIMER FUNCTIONS	9	TROUBLESHOOTING	16
ON/OFF TIMER.....	9	OPERATING TIPS.....	17
WEEKLY TIMER.....	10	SELF-DIAGNOSIS	19
TEMPERATURE SET BACK TIMER.....	12		

SAFETY PRECAUTIONS

- Before using the appliance, read these “SAFETY PRECAUTIONS” thoroughly and operate in the correct way.
- The instructions in this section all relate to safety; be sure to maintain safe operating conditions.
- “DANGER”, “WARNING” and “CAUTION” have the following meanings in these instructions:

	DANGER	This mark indicates procedures which, if improperly performed, are most likely to result in the death or serious injury to the user or service personnel.
	WARNING	This mark indicates procedures which, if improperly performed, might lead to the death or serious injury of the user or service personnel.
	CAUTION	This mark indicates procedures which, if improperly performed, might possibly result in personal harm to the user, or damage to property.

DANGER

- Do not attempt to install this air conditioner by yourself.
- This unit contains no user-serviceable parts. Always consult authorized service personnel for repairs.
- When moving, consult authorized service personnel for disconnection and installation of the air conditioner.
- Do not become excessively chilled by staying for many hours in the direct cooling airflow.
- Do not insert fingers or objects into the outlet port or intake grilles.
- Do not start and stop air conditioner operation by turning off the electrical breaker and so on.
- In the event of a malfunction (burning smell, etc.), immediately stop operation, turn off the electrical breaker, and consult authorized service personnel.
- In the event of refrigerant leakage, be sure to keep away from fire or any flammables. (consult an authorized service personnel)

CAUTION

- Provide occasional ventilation during use.
- Do not direct air flow at fireplaces or heating apparatus.
- Do not climb on, or place objects on, the air conditioner.
- Do not hang objects from the indoor unit.
- Do not set flower vases or water containers on top of air conditioners.
- Do not expose the air conditioner directly to water.
- Do not operate the air conditioner with wet hands.
- Do not touch the switches with sharp objects.
- Turn off power source when not using the unit for extended periods.
- Always turn off the electrical breaker whenever cleaning the air conditioner or changing the air filter.
- Connection valves become hot during Heating; handle with care.
- Check the condition of the installation stand for damage.
- Do not place animals or plants in the direct path of the air flow.
- When restarting after a long period of disuse in the winter, turn the power switch on at least 12 hours before starting the unit.
- Do not drink the water drained from the air conditioner.
- Do not use in applications involving the storage of foods, plants or animals, precision equipment, or art works.
- Do not apply any heavy pressure to radiator fins.
- Operate only with air filters installed.
- Do not block or cover the intake grille and outlet port.
- Ensure that any electronic equipment is at least 1m away from either the indoor or outdoor units.
- Avoid installing the air conditioner near a fireplace or other heating apparatus.
- When installing the indoor and outdoor units, take precautions to prevent access by infants.
- Do not use inflammable gases near the air conditioner.





SAFETY PRECAUTIONS



CAUTION

- This appliance is not intended for use by persons (including children) with reduced physical, sensory or mental capabilities, or lack of experience and knowledge, unless they have been given supervision or instruction concerning use of the appliance by a person responsible for their safety.
Children should be supervised to ensure that they do not play with the appliance.
- If you see lightning or hear thunder, there might be a lightning strike. To prevent electric shock hazard, turn off the air conditioner by using the remote controller, and do not touch the unit or the power plug during thunderstorm.
- Do not place any other electrical products or household belongings under indoor unit or outdoor unit. Dripping condensation from the unit might get them wet, and may cause damage or malfunction of your property.
- Keep clean and tidy around the outdoor unit, and do not place the things around it. If it is covered with fallen leaves, there could be an infiltration of small animals or insects whose contact with the internal electrical components leads to the product malfunction.
- Do not stand on unstable steps when operating or cleaning the air conditioner. It may overturn and can cause the injury.

FEATURES AND FUNCTIONS

■ Energy saving and Comfortable function

INVERTER

At the start of operation, large amount of power is used to bring the room quickly to the desired temperature. Afterwards, the unit automatically switches to a low power setting for economic and comfortable operation.

ECONOMY OPERATION

When ECONOMY operation mode is operated, the room temperature will be little higher than the set-temp under cooling mode and lower than set-temp under heating mode. Therefore, the ECONOMY mode is able to save more energy than other normal mode.

SUPER QUIET OPERATION

When the FAN button is used to select QUIET, the indoor unit begins super quiet operation; the indoor unit's airflow is reduced to produce quieter operation.

AUTO CHANGEOVER

The operation mode (cooling, dry, heating) is switched automatically to maintain the set temperature, and the temperature is kept constant at all times.

■ Convenient function

WEEKLY TIMER

Use this timer function to set operating times for each day of the week. Use the DAY OFF setting to switch off timed operation for a selected day in the coming week. Because all days can be set together, the weekly timer can be used to repeat the timer settings for all of the days.

TEMPERATURE SET BACK TIMER

Use this timer function to change the set temperature in the operation times set for each day of the week. This can be used together with other timer settings.

■ Clean function

REMOVABLE INTAKE GRILLE

The indoor unit's intake grille can be removed for easy cleaning and maintenance.

■ Remote controller

WIRED REMOTE CONTROLLER

The wired remote controller allows convenient control of indoor unit operation.

WIRELESS REMOTE CONTROLLER (OPTION)

The optional wireless remote controller can be used. When you use remote controller, there are following different points as compared with using wired remote controller.

[The additional function for wireless ones]

- SLEEP timer
- TIMER
- 10 °C HEAT operation

And you can use both wireless and wired remote controller simultaneously. (But function is limited.)

[The restricted functions for wired ones]

- Weekly timer
- Temperature set back timer

NAME OF PARTS

Indoor unit

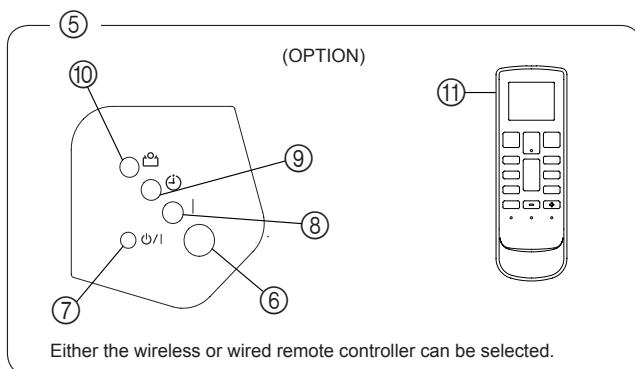
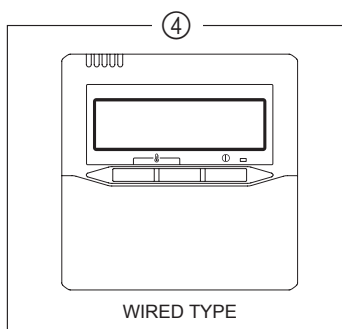
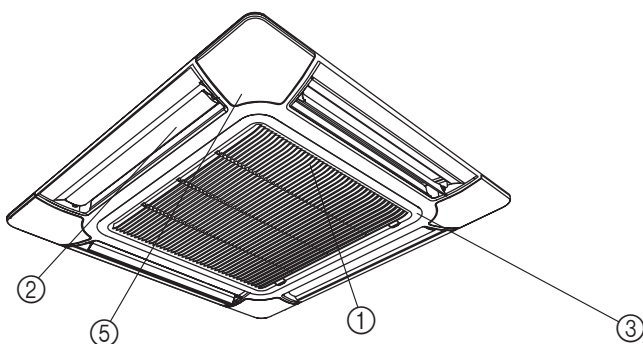

① Air filter (in air intake grille)

② Airflow direction flaps

③ Air intake grille

④ Remote controller (wired)

⑤ Control panel (OPTION)

⑥ Remote control signal receiver

⑦ MANUAL AUTO button

- When the MANUAL AUTO button is pressed in for more than 10 seconds, the forced cooling operation will start.

- The forced cooling operation is used at the time of installation. Only for authorized service personnel's use.

- When the forced cooling operation starts by any chance, press the START/STOP button to stop the operation.

- Please press the button at Filter Reset.

⑧ OPERATION indicator lamp (green)

⑨ TIMER indicator lamp (orange)

- TIMER indicator lamp lights when the timer is set from wireless remote controller.

⑩ ECONOMY indicator lamp (green)

- ECONOMY indicator lamp lights in following operations:
 - ECONOMY operation
 - 10 °C HEAT operation (controlled by wireless remote controller)

⑪ Remote controller (wireless)

NAME OF PARTS

Remote controller

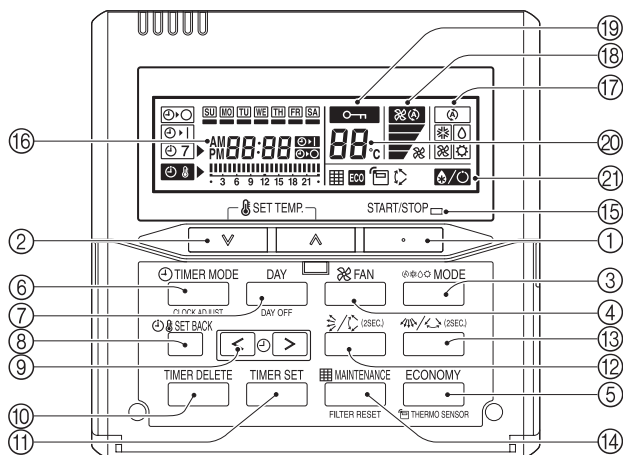

- | | |
|--|---|
| ① START/STOP button | ⑬ Horizontal airflow direction and Swing button^{*1} |
| ② SET TEMP. (temperature) button | ⑭ MAINTENANCE (FILTER RESET) button^{#1} |
| ③ MODE button | ⑮ Operation lamp |
| ④ FAN button | ⑯ Timer and Clock indicator |
| ⑤ ECONOMY button | ⑰ Operation mode indicator |
| ⑥ TIMER MODE (CLOCK ADJUST) button | ⑱ Fan speed indicator |
| ⑦ DAY (DAY OFF) button | ⑲ Operation lock indicator |
| ⑧ SET BACK button | ⑳ Temperature indicator |
| ⑨ SET TIME (< >) button | ㉑ Function indicator |
| ⑩ TIMER DELETE button | Defrost indicator |
| ⑪ TIMER SET button | Thermo sensor indicator |
| ⑫ Vertical airflow direction and Swing button | ECONOMY indicator |
| | Vertical swing indicator |
| | Filter indicator^{#1} |

*1 This function cannot be used.
(Please also see the operating manual of the option when using it with options, etc.)

#1 Can be used if set correctly during installation. Please consult authorized service personnel when using this function.



PREPARATORY OPERATION

Set the current day and time

1  TIMER MODE

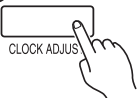

Press the TIMER MODE (CLOCK ADJUST) button for 2 seconds or more. The time indicator on the remote controller will flash.

2

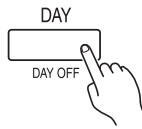

Press the DAY button and select the current day. A  appears around the selected day.

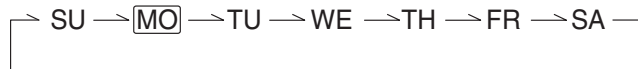

3

Press the SET TIME (< >) buttons to set the current time. Press repeatedly to adjust the current time in 1-minute increments. Press and hold to adjust the current time in 10-minute increments.

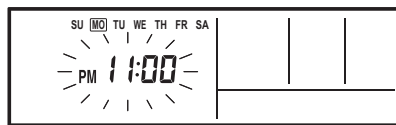
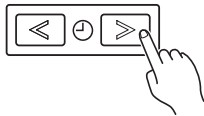

ex. Monday PM11:00

4

 SET BACK



Press the SET BACK button to switch between the 12- and 24-hour time displays.



5

 TIMER MODE

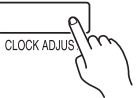

Press again to end.



OPERATION

Instructions relating to heating (*) are applicable only to "HEAT & COOL MODEL" (Reverse Cycle).

To start/stop operation

Press the START/STOP button.

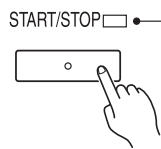

Operation lamp
 Air conditioner ON: Lit brightly
 Air conditioner OFF: Not lit

To set the operation mode

● Operation mode setting

Press the MODE button to set the operation mode.
 If DRY is selected, the fan speed will be set to AUTO.

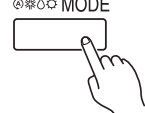
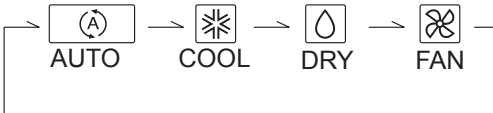
● Room temperature setting

Press the SET TEMP. buttons to set the room temperature.

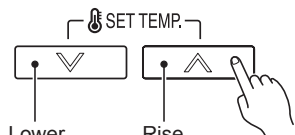

Temperature setting range

AUTO	18 to 30 °C
COOL/DRY	18 to 30 °C
HEAT*	16 to 30 °C



● Fan speed setting

Press the FAN button to set the fan speed.



ECONOMY operation

Press the ECONOMY button to start or stop ECONOMY operation.
 For details on the function, refer to page 14.

OPERATION

Room temperature sensor selection

- This function is locked at the factory. In order to detect the room temperature correctly, consult authorized service personnel when using this function.



Press the ECONOMY button for more than 2 seconds to select whether the room temperature is detected at the indoor unit or the remote controller.

When the  thermo sensor indicator appears, the room temperature is detected at the remote controller.

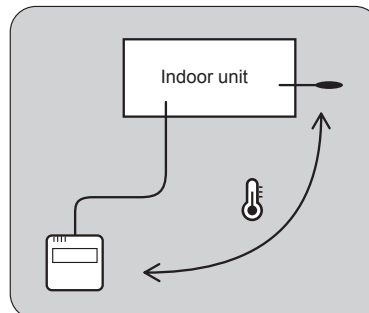

i NOTES

- If this function is locked, the location where the room temperature is detected cannot be changed and the  mark flashes when the ECONOMY button is pushed for 2 seconds or more.

Child lock function

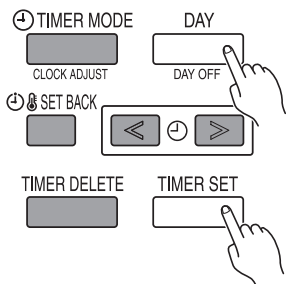

Press the DAY (DAY OFF) button and TIMER SET button simultaneously for 2 seconds or more to activate the child lock function and lock all of the buttons on the remote controller except the START/STOP button, SET TEMP. buttons, MODE button, and FAN button. Press the buttons again for 2 seconds or more to deactivate the child lock function. When the child lock function is activated, the  mark appears. If any button is pressed during the child lock, the **CL** indicator flashes.

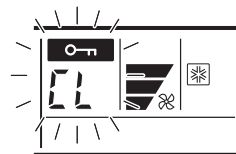

TIMER FUNCTIONS



OFF timer (See page 9.)

Use this timer function to stop air conditioner operation. The timer operates and air conditioner operation stops after the set time has passed. The timer can be set up to 24 hours in advance.



ON timer (See page 9.)

Use this timer function to start air conditioner operation. The timer operates and air conditioner operation starts after the set time has passed. The timer can be set up to 24 hours in advance.



WEEKLY timer (See page 10.)

Use this timer function to set operating times for each day of the week.
Use the DAY OFF setting to switch off timed operation for a selected day in the coming week.
Because all days can be set together, the weekly timer can be used to repeat the timer settings for all of the days.



Temperature SET BACK timer (See page 12.)

Use this timer function to change the set temperature in the operation times set for each day of the week.
This can be used together with other timer settings.

ON/OFF TIMER

To set the ON/OFF timer

1

TIMER MODE

CLOCK ADJUS



Press the TIMER MODE button to select the ON timer or OFF timer.

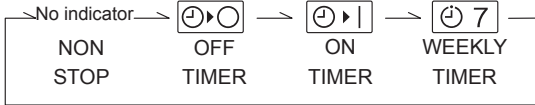

2



From 1 to 24 hours

ex. OFF timer set for 6 hours

Press the SET TIME (< >) buttons to set the time.
After the time is set, the timer will start automatically.
The amount of time until the OFF timer operates that is displayed on the timer indicator decreases as time passes.

• To cancel

TIMER DELETE

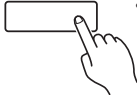

- Press the TIMER DELETE button to cancel the timer mode.
- The timer mode can also be canceled by changing the timer mode using the TIMER MODE button.

WEEKLY TIMER

Weekly timer setting

1 **TIMER MODE**

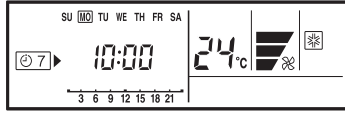

Press the TIMER MODE button to select the weekly timer.

2 **TIMER SET**



Press the TIMER SET button for 2 seconds or more.

3 • **Day of the week setting**

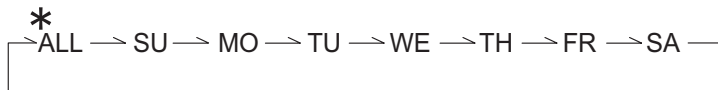
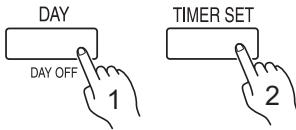

Press the DAY button to select the day of the week, and then press the TIMER SET button to confirm the setting.

* For ALL, all of the days can be set together when a appears around each day.

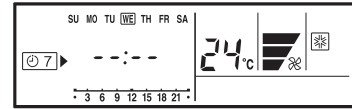

4 • **Time setting**

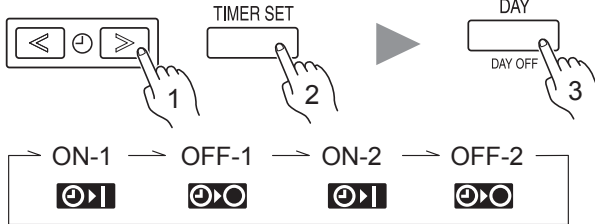

When the operating time is set, the mark appears.

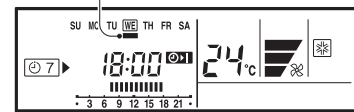

ex. The timer is set for 7:00-18:00.

Press the SET TIME (< >) buttons to set the time, and then press the TIMER SET button to confirm the setting and proceed to the next ON or OFF time setting. Up to 2 times ON and OFF times can be set per day. Press the DAY button to complete the time setting and return to the day of the week setting.

5 **TIMER SET**



Repeat steps **3** and **4**.
To complete the weekly timer settings, press the TIMER SET button for 2 seconds or more.

• **To delete the operating time**

TIMER DELETE

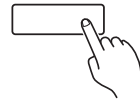

If the TIMER DELETE button is pressed during steps **3** or **4**, the operating time for the selected day will be deleted.

If all the days are selected, the operating times for all of the days will be deleted.

i NOTES

- The operating time can be set in 30-minute increments only.
- The OFF time can be carried over to the next day.
- The ON timer and the OFF timer functions cannot be set using the weekly timer. Both an ON and OFF time must be set.

WEEKLY TIMER

WEEKLY timer operation

To start

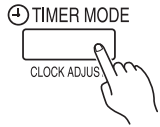

When the weekly timer is selected, the timer starts automatically.

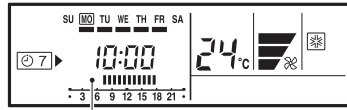

The operating time for the current day is displayed.

To cancel



- Press the TIMER DELETE button to cancel the timer mode.
- The timer mode can also be canceled by changing the timer mode using the TIMER MODE button.

To set the DAY OFF (for a holiday)

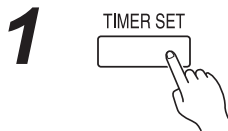

During the weekly timer, press the TIMER SET button for 2 seconds or more to set the day.

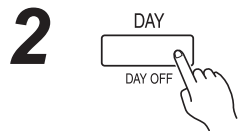

Select the day to set the DAY OFF.

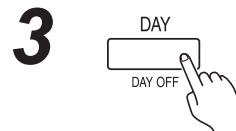

Press the DAY (DAY OFF) button for 2 seconds or more to set the DAY OFF.

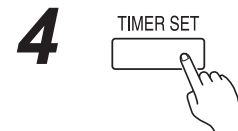

Press the TIMER SET button for 2 seconds or more to complete the DAY OFF setting.

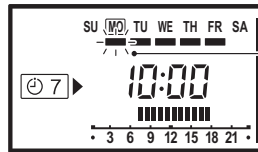
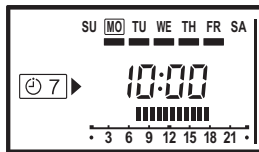

The  mark flashes under a day of the week.

ex. The DAY OFF is set for Monday.

To cancel

Follow the same procedures as those for setup.

NOTES

- The DAY OFF setting is only available for days for which weekly settings already exist.
- If the operating time carries over to the next day (during a next day setting), the effective DAY OFF range will be set as shown below.

Normal

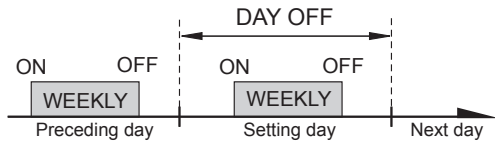

Next day setting

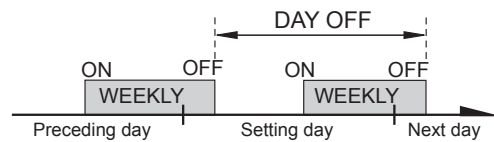

- The DAY OFF setting can only be set 1 time. The DAY OFF setting is cancelled automatically after the set day has passed.

TEMPERATURE SET BACK TIMER

Temperature SET BACK timer setting

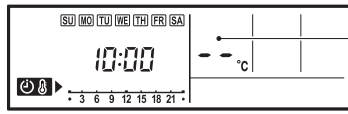
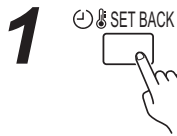

If there is no existing SET BACK temperature setting, "--" will be displayed for the temperature.

Press the SET BACK button to change to the SET BACK confirmation display. The SET BACK operating time and the set temperature will be displayed.

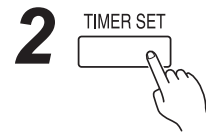

Press the TIMER SET button for 2 seconds or more.

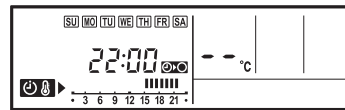
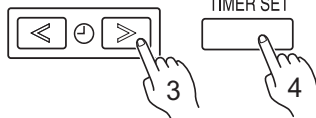
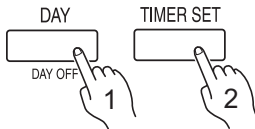

ex. When setting all days together

Follow the same procedures to set the operating time as those for the weekly timer. The TIMER DELETE button is also used as described in the procedures for the weekly timer.



Press the SET TEMP. buttons to set the temperature. (The temperature setting range is the same as the range for the operation mode.)

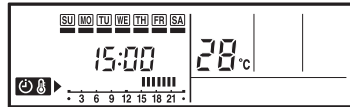
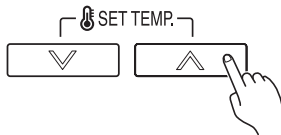

ex. Operating time 15:00–22:00

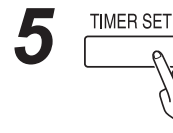
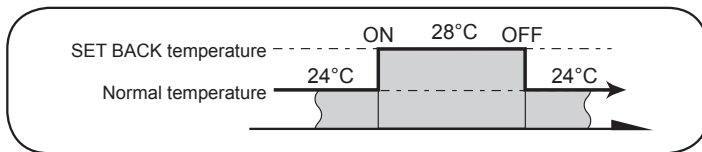

Repeat steps **3** and **4**. Press the TIMER SET button for 2 seconds or more to complete the temperature SET BACK timer settings.

Temperature SET BACK timer operation

• To start

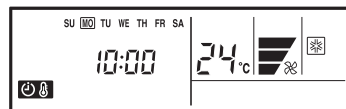

ex. Display during SET BACK timer operation (The operating time will not be displayed.)

Press the SET BACK button. The SET BACK confirmation display appears for 5 seconds, and then the timer starts automatically.

• To cancel

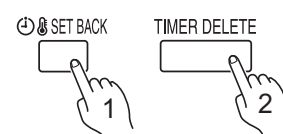

Press the SET BACK button, and then press the TIMER DELETE button while the SET BACK confirmation display is displayed. Even if the SET BACK button is pressed again, the SET BACK timer will be cancelled.

NOTES

- The SET BACK timer only changes the set temperature, it cannot be used to start or stop air conditioner operation.
- The SET BACK timer can be set to operate up to 2 times per day but only 1 temperature setting can be used.
- The SET BACK timer can be used together with the ON, OFF, and weekly timer functions.
- The SET BACK operating time is displayed only in the SET BACK confirmation display. (Refer to step 1 for the SET BACK confirmation display.)



ADJUSTING THE DIRECTION OF AIR CIRCULATION

Instructions relating to heating (*) are applicable only to "HEAT & COOL MODEL" (Reverse Cycle).
Start air conditioner operation before performing this procedure.

To set the operation mode

● Vertical air direction adjustment

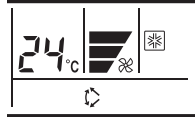
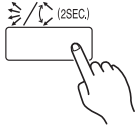

Press the **START/STOP** button to start the air conditioner, and then proceed as follows.

Press the vertical airflow direction and swing button to adjust the direction of the vertical airflow.

Each time the button is pressed, the air direction range will change as follows:

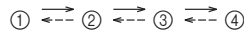

The remote controller display does not change.

Recommended airflow direction setting:

- ①, ②, ③, ④: During cooling/dry mode
- ②, ③, ④: During heating mode

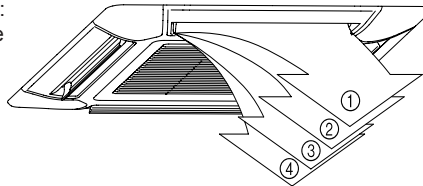

- Attempting to move up/down air direction flaps manually could result in improper operation; in this case, stop operation and restart. The louvers should begin to operate properly again.
- When used in a room with infants, children, elderly or sick persons, the air direction and room temperature should be considered carefully when making settings.

- The vertical airflow direction is set automatically as shown, in accordance with the type of operation selected.

During cooling/dry mode : Horizontal flow ①

During heating mode* : Downward flow ④

- During AUTO mode operation, for the first minute after beginning operation, airflow will be horizontal ①; the air direction cannot be adjusted during this period.

● Horizontal air direction adjustment.

The function cannot be used.



SWING OPERATION

Begin air conditioner operation before performing this procedure.

To select/stop swing operation

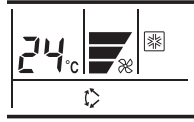
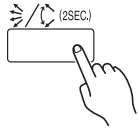

Press the vertical airflow direction and swing button for more than 2 seconds. (Stop the setting by pressing for more than 2 seconds again.)

About Swing Operation

The type of operation	Range of swing
Cooling/Heating/Dry/Fan	① to ④

- The swing operation may stop temporarily when the air conditioner's fan is not operating, or when operating at very low speeds.

ECONOMY OPERATION

Begin air conditioner operation before performing this procedure.

To Use the ECONOMY Operation

Press the ECONOMY button.

The ECONOMY indicator will light.
ECONOMY operation begins.

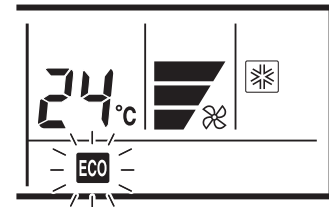

To Stop the ECONOMY Operation

Press the ECONOMY button again.

The ECONOMY indicator will go out.
Normal operation begins.



About ECONOMY Operation

At the maximum output, ECONOMY operation is approximately 70% of normal air conditioner operation for cooling and heating.

- If the room is not cooled (or heated) well during ECONOMY operation, select normal operation.
- During the monitor period in the AUTO mode, the air conditioner operation will not change to ECONOMY operation even if ECONOMY operation is selected by pressing the ECONOMY operation button.
- When ECONOMY operation mode is operated, the room temperature will be little higher than the set-temp under cooling mode and lower than set-temp under heating mode. Therefore, the ECONOMY mode is able to save more energy than other normal mode.
- In case of multi-type air conditioner, the ECONOMY operation mode is only available for the set indoor unit.



CLEANING AND CARE



CAUTION

- Before cleaning the unit, be sure to stop the unit and disconnect the power supply.
- Turn off the electrical breaker.
- A fan operates at high speed inside the unit, and personal injury could result.
- Be careful not to drop the intake grille.
- As the filter cleaning involves high-altitude operation, please consult the professional technical service personnel.

- When used for extended periods, the unit may accumulate dirt inside, reducing its performance. We recommend that the unit be inspected regularly, in addition to your own cleaning and care. For more information, consult authorized service personnel.
- When cleaning the unit's body, do not use water hotter than 40 °C, harsh abrasive cleansers, or volatile agents like benzene or thinner.
- Do not expose the unit body to liquid insecticides or hairsprays.
- If the unit will not be operated for a period of one month or more, be sure to allow the inner parts of the unit to dry thoroughly, in advance, by operating the unit in fan mode for half a day.

Cleaning the Air Filter

1. Push the intake grille's hooks inward towards the center of the unit to open the intake grille.

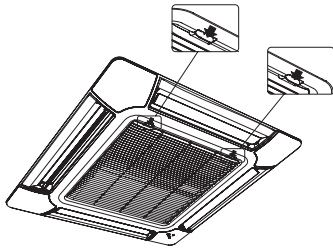

2. Pull out the filter from the intake grille.

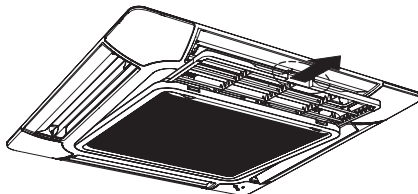

3. Clean the air filter.

Remove the dust from the air filters by vacuuming or washing them. After washing, allow the air filters to dry thoroughly in an area protected from sunlight.

- Dust can be cleaned from the air filter either with a vacuum cleaner, or by washing the filter in a solution of mild detergent and warm water. If you wash the filter, be sure to allow it to dry thoroughly in a shady place before reinstalling.
- If dirt is allowed to accumulate on the air filter, air flow will be reduced, lowering operating efficiency and increasing noise.

4. Re-attach the air filters to the intake grille.

- ① Replace the air filter into its holder.
- ② Make sure that the air filter makes contact with the filter stopper when it is replaced into its holder.

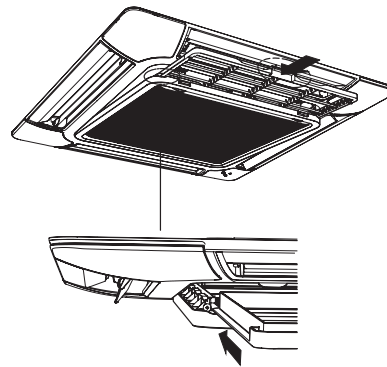

5. Close the intake grille and push the intake grille's hooks outward.

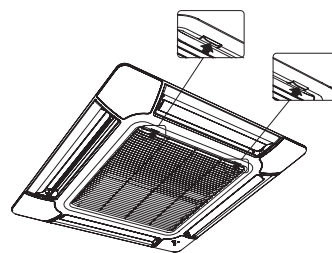

Filter indicator Reset (A special setting)

- Can be used if set correctly during installation. Please consult authorized service personnel when using this function.
 - It lights on when it is time to clean the air filters.

After turning the power on.
Press the MAINTENANCE button for 2 seconds or more on the remote control.
The filter indicator will disappear.

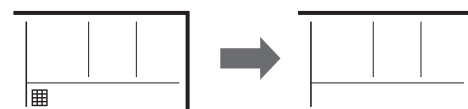



TROUBLESHOOTING

Instructions relating to heating (*) are applicable only to "HEAT & COOL MODEL" (Reverse Cycle).

WARNING

In the event of a malfunction (burning smell, etc.), immediately stop operation, turn off the electrical breaker, and consult authorized service personnel.
Merely turning off the unit's power switch will not completely disconnect the unit from the power source. Always be sure to turn off the electrical breaker to ensure that power is completely off.

Before requesting service, perform the following checks:

	Symptom	Problem	See Page
NORMAL FUNCTION	Does not operate immediately:	<ul style="list-style-type: none"> ● If the unit is stopped and then immediately started again, the compressor will not operate for about 3 minutes, in order to prevent fuse blowouts. ● Whenever the electrical breaker is turned off then on again, the protection circuit will operate for about 3 minutes, preventing unit operation during that period. 	—
	Noise is heard:	<ul style="list-style-type: none"> ● During operation and immediately after stopping the unit, the sound of water flowing in the air conditioner's piping may be heard. Also, noise may be particularly noticeable for about 2 to 3 minutes after starting operation (sound of coolant flowing). ● During operation, a slight squeaking sound may be heard. This is the result of minute expansion and contraction of the front cover due to temperature changes. 	—
		* ● During heating operation, a sizzling sound may be heard occasionally. This sound is produced by the automatic defrosting operation.	17
	Smells:	<ul style="list-style-type: none"> ● Some smell may be emitted from the indoor unit. This smell is the result of room smells (furniture, tobacco, etc.) which have been taken into the air conditioner. 	—
	Mist or steam are emitted:	<ul style="list-style-type: none"> ● During cooling or dry operation, a thin mist may be seen emitted from the indoor unit. This results from the sudden cooling of room air by the air emitted from the air conditioner, resulting in condensation and misting. 	—
		* ● During heating operation, the outdoor unit's fan may stop, and steam may be seen rising from the unit. This is due to the automatic defrosting operation.	17
	Airflow is weak or stops:	* ● When heating operation is started, fan speed is temporarily very low, to allow internal parts to warm up.	—
		* ● During heating operation, if the room temperature rises above the thermostat setting, the outdoor unit will stop, and the indoor unit will operate at very low fan speed. If you wish to warm the room further, set the thermostat to a higher setting.	—
		* ● During heating operation, the unit will temporarily stop operation (between 4 and 15 minutes) as the automatic defrosting mode operates. During the automatic defrosting operation,  will be shown on the remote controller display.	17
		● The fan may operate at very low speed during dry operation or when the unit is monitoring the room's temperature.	—
		● During QUIET operation, the fan will operate at very low speed.	—
	● In the monitor AUTO operation, the fan will operate at very low speed.	—	
Water is produced from the outdoor unit:	* ● During heating operation, water may be produced from the outdoor unit due to the automatic defrosting operation.	17	
The FILTER indicator blinks:	● Clean the filter. Afterwards, turn the FILTER indicator off.	15	
 thermo sensor indicator on the remote controller is flashing:	● The room temperature sensor may be malfunctioning. Please consult authorized service personnel.	—	

En-16

TROUBLESHOOTING

	Symptom	Items to check	See Page
CHECK ONCE MORE	Does not operate at all:	<ul style="list-style-type: none"> ● Has the circuit breaker been turned off? ● Has there been a power failure? ● Has a fuse blown out, or a circuit breaker been tripped? 	—
		<ul style="list-style-type: none"> ● Is the timer operating? 	9 to 11
	Poor cooling (or heating*) performance:	<ul style="list-style-type: none"> ● Is the air filter dirty? ● Are the air conditioner's intake grille or outlet port blocked? ● Did you adjust the room temperature settings (thermostat) correctly? ● Is there a window or door open? ● In the case of cooling operation, is a window allowing bright sunlight to enter? (close the curtains.) ● In the case of cooling operation, are there heating apparatus and computers inside the room, or are there too many people in the room? 	—
		<ul style="list-style-type: none"> ● Is the unit set for QUIET operation? 	—

If the problem persists after performing these checks, or if you notice burning smells, stop operation immediately, disconnect the power supply, and consult with authorized service personnel.

OPERATING TIPS

Instructions relating to heating (*) are applicable only to "HEAT & COOL MODEL" (Reverse Cycle).

Heating Performance*

- This air conditioner operates on the heat-pump principle, absorbing heat from outdoor air and transferring that heat indoors. As a result, the operating performance is reduced as outdoor air temperature drops. If you feel that insufficient heating performance is being produced, we recommend you use this air conditioner in conjunction with another kind of heating appliance.
- Heat-pump air conditioners heat your entire room by recirculating air throughout the room, with the result that some time may be required after first starting the air conditioner until the room is heated.

When Indoor and Outdoor Temperature are High*

When both indoor and outdoor temperatures are high during use of the heating mode, the outdoor unit's fan may stop at times.

Fan speed: AUTO

- Heating* : The fan will operate at very low speed when the temperature of the air issued from the indoor unit is low.
 Cooling : As the room temperature approaches that of the set temperature, the fan speed becomes slower.
 Fan : The fan runs at the low fan speed.

Microcomputer-controlled Automatic Defrosting*

- When using the heating mode under conditions of low outdoor temperature and high humidity, frost may form on the outdoor unit, resulting in reduced operating performance. In order to prevent this kind of reduced performance, this unit is equipped with a microcomputer-controlled automatic defrosting function. During the defrost cycle, the indoor fan will shutdown and  will be displayed on the remote controller. It will take anywhere from 4 to 15 minutes before the air conditioner starts up again.

- After heating operation stops, if frost forms on the outdoor unit, the unit will start automatic defrosting operation. At this time, the outdoor unit will automatically stop after operating for a few minutes.

Low Ambient Cooling

When the outdoor temperature drops, the outdoor unit's fans may switch to low speed, or one of the fans may stop intermittently.

Hot Start*

The indoor unit prevents cold drafts when heating operation begins. The indoor unit fan will not operate or it will operate at a very low speed until the heat exchanger reaches the set temperature.

Dual Remote Controllers (optional)

An additional remote controller can be added up to the maximum of two remote controllers. Either remote controller can control the air conditioner. However, the timer functions cannot be used at the slave unit.

Group Control

One remote controller can control up to 16 air conditioners. All of the air conditioners will be operated with the same settings.

OPERATING TIPS

Instructions relating to heating (*) are applicable only to "HEAT & COOL MODEL" (Reverse Cycle).

Mode operation

AUTO (in COOLING model):

- When AUTO (automatic changeover) operation first selected, the fan will operate at very low speed for about a few minutes, during which time the indoor unit detects the room conditions and selects the proper mode.

Room temperature is higher than the defined temperature in temperature setting
→ Cooling mode or dry mode

Room temperature is close to or lower than the defined temperature in temperature setting → Monitor operation

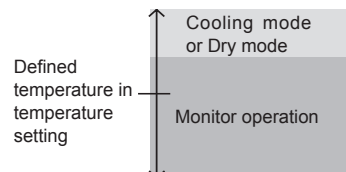

- When the indoor unit has adjusted your room's temperature to near the temperature setting, it will begin monitor operation. In the monitor operation mode, the fan will operate at low speed. If the room temperature subsequently changes, the indoor unit will once again select the appropriate operation (cooling) to adjust the temperature to the value set in the temperature setting.
- If the mode automatically selected by the unit is not what you wish, select one of the mode operation (COOL, DRY, FAN).

AUTO [in HEAT & COOL (Reverse Cycle) model]:

- When AUTO (automatic changeover) is selected, the air conditioner selects the appropriate operation mode (cooling or heating) according to your room's present temperature.
- When AUTO (automatic changeover) operation first selected, the fan will operate at low speed for about a few minute, during which time the indoor unit detects the room conditions and selects the proper operation mode.

Room temperature is higher than the defined temperature in temperature setting → Cooling mode or dry mode

Room temperature is close to the defined temperature in temperature setting → Determined by outdoor temperature

Room temperature is lower than the defined temperature in temperature setting → Heating mode

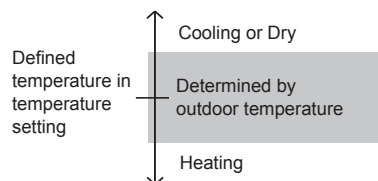

- When the air conditioner has adjusted your room's temperature to near the thermostat setting, it will begin monitor operation. In the monitor operation mode, the fan will operate at low speed. If the room temperature subsequently changes, the air conditioner will once again select the appropriate operation (heating, cooling) to adjust the temperature to the value set in the thermostat.
- If the mode automatically selected by the unit is not what you wish, select one of the mode operation (HEAT, COOL, DRY, FAN).

HEAT*:

- Use to warm your room.
- When heating mode is selected, the air conditioner will operate at very low fan speed for about 3 to 5 minutes, after which it will switch to the selected fan setting. This period of time is provided to allow the indoor unit to warm up before beginning full operation.
- When the room temperature is very low, frost may form on the outside unit, and its performance may be reduced. In order to remove such frost, the unit will automatically enter the defrost cycle from time to time. During automatic defrosting operation, the heat operation will be interrupted.
- After the start of heating operation, it takes sometime before the room gets warmer.

COOL:

- Use to cool your room.

DRY:

- Use for gently cooling while dehumidifying your room.
- You cannot heat the room during dry mode.
- During dry mode, the unit will operate at low speed; in order to adjust room humidity, the indoor unit's fan may stop from time to time. Also, the fan may operate at very low speed when adjusting room humidity.
- The fan speed cannot be changed manually when dry mode has been selected.

FAN:

- Use to circulate the air throughout your room.

During heating mode:

Set the thermostat to a temperature setting that is higher than the current room temperature. The heating mode will not operate if the thermostat is set lower than the actual room temperature.

During cooling/dry mode:

Set the thermostat to a temperature setting that is lower than the current room temperature. The cooling and dry modes will not operate if the thermostat is set higher than the actual room temperature (in cooling mode, the fan alone will operate).

During fan mode:

You can not use the unit to heat and cool your room.



OPERATING TIPS

AUTO Restart

In Event of Power Interruption

- Should the power supply to the air conditioner be interrupted by a power failure, the air conditioner will restart automatically in the previously selected mode once the power is restored.
- Use of other electrical appliances (electric shaver, etc.) or nearby use of a wireless radio transmitter may cause the air conditioner to malfunction. In this event, temporarily disconnect the power supply, reconnect it, and then use the remote controller to resume operation.

Notices

- * ● During use of the heating mode, the outdoor unit will occasionally commence the defrost operation for brief periods. During the defrosting operation, if the user sets the indoor unit for heating again, the defrosting mode will continue, and the heating operation will begin after completion of defrosting, with the result that some time may be required before warm air is emitted.
- * ● During use of the heating mode, the top of the indoor unit may become warm, but this is due to the fact that coolant is circulated through the indoor unit even when it is stopped; it is not a malfunction.

SELF-DIAGNOSIS

When "Er" in temperature indicator is displayed, inspection of the air conditioning system is necessary. Please consult authorized service personnel.

Unit number (usually "00")

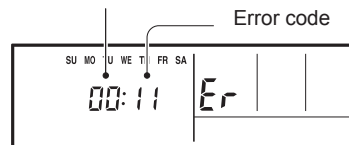

ex. Self-diagnosis check