

AIR CONDITIONER  
**Compact Cassette Type**

**OPERATING MANUAL**  
**BEDIENUNGSANLEITUNG**  
**MODE D'EMPLOI**  
**MANUAL DE FUNCIONAMIENTO**  
**MANUALE DI ISTRUZIONI**  
**ΕΓΧΕΙΡΙΔΙΟ ΛΕΙΤΟΥΡΓΙΑΣ**  
**MANUAL DE INSTRUÇÕES**  
**РУКОВОДСТВО ПО ЭКСПЛУАТАЦИИ**  
**KULLANMA KİTABI**  
使用説明書

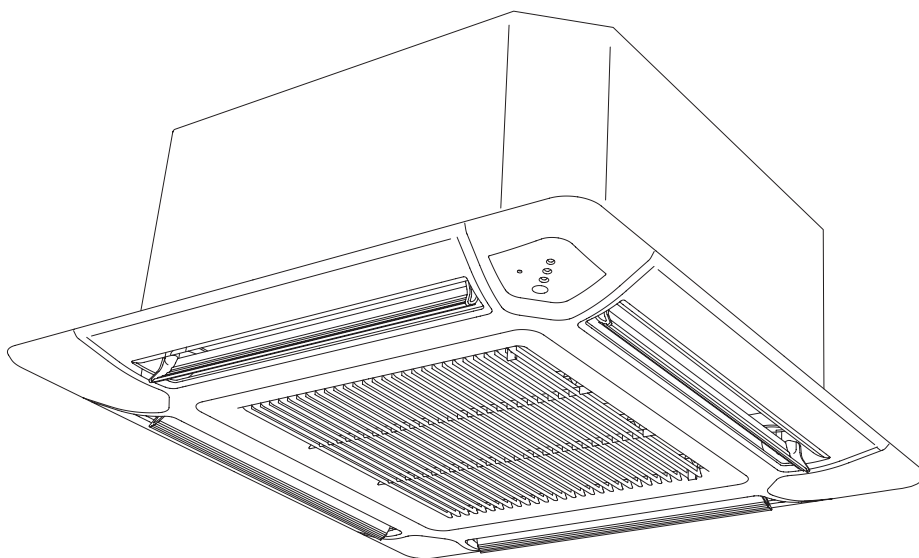

KEEP THIS MANUAL FOR FUTURE REFERENCE  
BEWAHREN SIE DIESES HANDBUCH ZUM SPÄTEREN NACHSCHLAGEN AUF  
CONSERVEZ CE MANUEL POUR RÉFÉRENCE ULTÉRIEURE  
CONSERVE ESTE MANUAL PARA SU FUTURA CONSULTA  
CONSERVARE IL PRESENTE MANUALE PER FUTURE CONSULTAZIONI  
ΦΥΛΑΞΤΕ ΤΟ ΕΓΧΕΙΡΙΔΙΟ ΓΙΑ ΜΕΛΛΟΝΤΙΚΗ ΑΝΑΦΟΡΑ  
GUARDE ESTE MANUAL PARA REFERÊNCIA FUTURA  
РУКОВОДСТВО ДЛЯ СПРАВOK В БУДУЩЕМ  
BU KILAVUZU, DAHA SONRA BAŞVURMAK ÜZERE SAKLAYIN  
請保存本說明書以供日後參考

PART NO. 9374379422-02

English

Deutsch

Français

Español

Italiano

Ελληνικά

Portugués

Русский

Türkçe



中國語

# CONTENTS

SAFETY PRECAUTIONS.....	2	ADJUSTING THE DIRECTION OF AIR CIRCULATION .....	11
FEATURES AND FUNCTIONS .....	3	SWING OPERATION .....	11
NAME OF PARTS .....	4	ECONOMY OPERATION .....	12
PREPARATION .....	6	10°C HEAT OPERATION .....	12
OPERATION.....	7	SELECTING THE REMOTE CONTROLLER	
TIMER OPERATION .....	9	SIGNAL CODE .....	13
SLEEP TIMER OPERATION .....	10	CLEANING AND CARE.....	14
MANUAL AUTO OPERATION .....	10	TROUBLESHOOTING .....	15
		OPERATING TIPS.....	17

## SAFETY PRECAUTIONS

- Before using the appliance, read these “PRECAUTIONS” thoroughly and operate in the correct way.
- The instructions in this section all relate to safety; be sure to maintain safe operating conditions.
- “DANGER”, “WARNING” and “CAUTION” have the following meanings in these instructions:

 <b>DANGER</b>	This mark indicates procedures which, if improperly performed, are most likely to result in the death or serious injury to the user or service personnel.
 <b>WARNING</b>	This mark indicates procedures which, if improperly performed, might lead to the death or serious injury of the user or service personnel.
 <b>CAUTION</b>	This mark indicates procedures which, if improperly performed, might possibly result in personal harm to the user, or damage to property.

### **DANGER**

- Do not attempt to install this air conditioner by yourself.
- This unit contains no user-serviceable parts. Always consult authorized service personnel for repairs.
- When moving, consult authorized service personnel for disconnection and installation of the air conditioner.
- Do not become excessively chilled by staying for many hours in the direct cooling airflow.
- Do not insert fingers or objects into the outlet port or intake grilles.
- Do not start and stop air conditioner operation by turning off the electrical breaker.
- Take care not to damage the power supply cord.
- In the event of a malfunction (burning smell, etc.), immediately stop operation, turn off the electrical breaker, and consult authorized service personnel.
- If the power supply cord of this appliance is damaged, it should only be replaced by the authorized service personnel, since special purpose tools and specified cord are required.
- In the event of refrigerant leakage, be sure to keep away from fire or any flammables. (consult an authorized service personnel)

### **CAUTION**

- Provide occasional ventilation during use.
- Do not direct air flow at fireplaces or heating apparatus.
- Do not climb on, or place objects on, the air conditioner.
- Do not hang objects from the indoor unit.
- Do not set flower vases or water containers on top of air conditioners.
- Do not expose the air conditioner directly to water.
- Do not operate the air conditioner with wet hands.
- Do not pull power supply cord.
- Turn off power source when not using the unit for extended periods.
- Always turn off the electrical breaker whenever cleaning the air conditioner or changing the air filter.
- Connection valves become hot during Heating; handle with care.
- Check the condition of the installation stand for damage.
- Do not place animals or plants in the direct path of the air flow.
- When restarting after a long period of disuse in the winter, turn the power switch on at least 12 hours before starting the unit.
- Do not drink the water drained from the air conditioner.
- Do not use in applications involving the storage of foods, plants or animals, precision equipment, or art works.
- Do not apply any heavy pressure to radiator fins.
- Operate only with air filters installed.
- Do not block or cover the intake grille and outlet port.
- Ensure that any electronic equipment is at least 1 m away from either the indoor or outdoor units.
- Avoid installing the air conditioner near a fireplace or other heating apparatus.
- When installing the indoor and outdoor units, take precautions to prevent access by infants.

# SAFETY PRECAUTIONS

## CAUTION

- Do not use inflammable gases near the air conditioner.
- This appliance is not intended for use by persons (including children) with reduced physical, sensory or mental capabilities, or lack of experience and knowledge, unless they have been given supervision or instruction concerning use of the appliance by a person responsible for their safety.  
Children should be supervised to ensure that they do not play with the appliance.
- If you see lightning or hear thunder, there might be a lightning strike. To prevent electric shock hazard, turn off the air conditioner by using the remote controller, and do not touch the unit or the power plug during thunderstorm.
- Do not place any other electrical products or household belongings under indoor unit or outdoor unit. Dripping condensation from the unit might get them wet, and may cause damage or malfunction of your property.
- Keep clean and tidy around the outdoor unit, and do not place the things around it. If it is covered with fallen leaves, there could be an infiltration of small animals or insects whose contact with the internal electrical components leads to the product malfunction.
- Do not stand on unstable steps when operating or cleaning the air conditioner. It may overturn and can cause the injury.

# FEATURES AND FUNCTIONS

## ■ Energy saving and Comfortable function

### INVERTER

At the start of operation, large amount of power is used to bring the room quickly to the desired temperature. Afterwards, the unit automatically switches to a low power setting for economic and comfortable operation.

### ECONOMY OPERATION

When ECONOMY operation mode is operated, the room temperature will be little higher than the set-temp under cooling mode and lower than set-temp under heating mode. Therefore, the ECONOMY mode is able to save more energy than other normal mode.

### SWING OPERATION

The airflow direction louvers swings automatically up and down so that the air speeds to every nook and corner of your room.

### SUPER QUIET OPERATION

When the FAN button is used to select QUIET, the indoor unit begins super quiet operation; the indoor unit's airflow is reduced to produce quieter operation.

### AUTO CHANGEOVER

The operation mode (cooling, dry, heating) is switched automatically to maintain the set temperature, and the temperature is kept constant at all times.

### 10°C HEAT OPERATION

The room temperature can be maintained at 10°C so as to prevent the room temperature from falling too far.

## ■ Convenient function

### PROGRAM TIMER

The program timer allows you to integrate OFF timer and ON timer operations in a single sequence. The sequence can involve 1 transition from OFF timer to ON timer, or from ON timer to OFF timer, within a 24 hour period.

## SLEEP TIMER

### ● COOLING MODEL

When the SLEEP timer button is pressed during cooling or dry mode, the thermostat setting is gradually raised during the period of operation. When the set time is reached, the unit automatically turns off.

### ● HEAT & COOL MODEL (REVERSE CYCLE)

When the SLEEP timer button is pressed during heating mode, the air conditioner's thermostat setting is gradually lowered during the period of operation; during cooling or dry mode, the thermostat setting is gradually raised during the period of operation. When the set time is reached, the unit automatically turns off.

## ■ Clean function

### REMOVABLE INTAKE GRILLE

The indoor unit's intake grille can be removed for easy cleaning and maintenance.

### MILDEW-RESISTANT FILTER

The air filter has been treated to resist mildew growth, thus allowing cleaner use and easier care.

## ■ Remote controller

### WIRELESS REMOTE CONTROLLER

The wireless remote controller allows convenient control of air conditioner operation.

### WIRED REMOTE CONTROLLER (OPTION)

The optional wired remote controller can be used.

When you use remote controller, there are following different points as compared with using wireless remote controller.

[The additional functions for wired ones]

- Weekly timer
- Temperature set back timer

And you can use both wired and wireless remote controller simultaneously. (But function is limited)

When the restricted functions on the remote controller are used, beeping sound will be heard, OPERATION, TIMER and the 3rd lamp of the indoor unit will flash.

[The restricted functions for wireless ones]

- SLEEP timer
- TIMER
- 10°C HEAT operation

# NAME OF PARTS

## Indoor unit

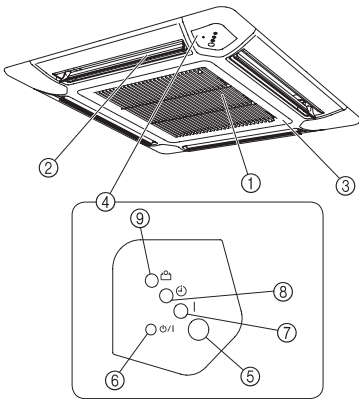

- ① **Air Filter (in air intake grille)**
- ② **Airflow direction flaps**
- ③ **Air intake grille**
- ④ **Control panel**
- ⑤ **Remote control signal receiver**
- ⑥ **MANUAL AUTO button**
  - When the MANUAL AUTO button is pressed in for more than 10 seconds, the forced cooling operation will start.
  - The forced cooling operation is used at the time of installation. Only for authorized service personnel's use.
  - When the forced cooling operation starts by any chance, press the START/STOP button to stop the operation.
  - Please press the button at Filter Reset.
- ⑦ **OPERATION indicator lamp (green)**
- ⑧ **TIMER indicator lamp (orange)**

TIMER indicator lamp lights when the timer is set from wireless remote control.
- ⑨ **ECONOMY indicator lamp (green)**

ECONOMY indicator lamp lights in following operations:

  - ECONOMY operation
  - 10°C HEAT operation (controlled by wireless remote controller)

# NAME OF PARTS

## Remote controller

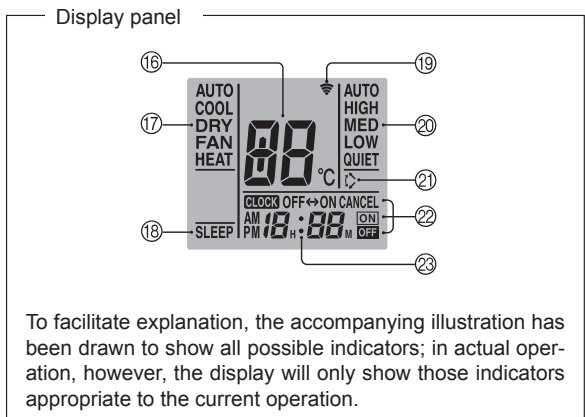
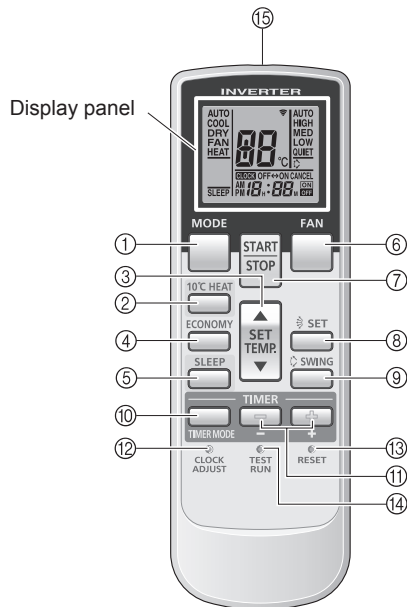

To facilitate explanation, the accompanying illustration has been drawn to show all possible indicators; in actual operation, however, the display will only show those indicators appropriate to the current operation.

- ① **MODE button**
- ② **10°C HEAT button**
- ③ **SET TEMP. button (▲ / ▼)**
- ④ **ECONOMY button**
- ⑤ **SLEEP button**
- ⑥ **FAN button**
- ⑦ **START/STOP button**
- ⑧ **SET button**
- ⑨ **SWING button**
- ⑩ **TIMER MODE button**
- ⑪ **TIMER SET ( + / - ) button**
- ⑫ **CLOCK ADJUST button**
- ⑬ **RESET button**
- ⑭ **TEST RUN button**
  - This button is used when installing the conditioner, and should not be used under normal conditions, as it will cause the air conditioner's thermostat function to operate incorrectly.
  - If this button is pressed during normal operation, the unit will switch to test operation mode, and the indoor unit's OPERATION indicator lamp and TIMER indicator lamp will begin to flash simultaneously.
  - To stop the test operation mode, press the START/STOP button to stop the air conditioner.

- ⑮ **Signal transmitter**
- ⑯ **Temperature SET indicator**
- ⑰ **Operating mode indicator**
- ⑱ **SLEEP indicator**
- ⑲ **Transmit indicator**
- ⑳ **Fan speed indicator**
- ㉑ **SWING indicator**
- ㉒ **Timer mode indicator**
- ㉓ **Clock indicator**

Some indoor units may not be equipped with the functions corresponding to all of the buttons on this remote controller. The indoor unit will beep and the OPERATION, TIMER and ECONOMY lamp flash when a remote controller button is pressed if the function is not available.

# PREPARATION

## Load Batteries (R03/LR03 × 2)

### 1 Press and slide the battery compartment lid on the reverse side to open it.

Slide in the direction of the arrow while pressing the  mark.

### 2 Insert batteries.

Be sure to align the battery polarities ( $\oplus/\ominus$ ) correctly.

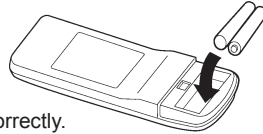

### 3 Close the battery compartment lid.

## Set the Current Time

### 1 Press the CLOCK ADJUST button.

Use the tip of a ball-point pen or other small object to press the button.

### 2 Use the TIMER SET ( $\oplus$ / $\ominus$ ) buttons to adjust the clock to the current time.

 button: Press to advance the time.

 button: Press to reverse the time.

(Each time the buttons are pressed, the time will be advanced/reversed in 1 minute increments; hold the buttons depressed to change the time quickly in 10 minute increments.)

### 3 Press the CLOCK ADJUST button again.

This completes the time setting and starts the clock.

## To Use the Remote controller

- The Remote controller must be pointed at signal receiver to operate correctly.
- Operating range: About 7 meters.
- When a signal is properly received by the air conditioner, a beeping sound will be heard.
- If no beep is heard, press the Remote controller button again.

## Remote controller Holder

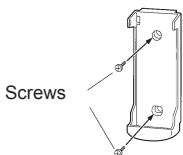

① Mount the Holder.

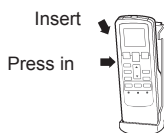

② Set the Remote controller

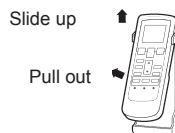

③ To remove the Remote controller (when use at hand).

## ⚠ CAUTION

- Take care to prevent infants from accidentally swallowing batteries.
- When not using the remote controller for an extended period, remove the batteries to avoid possible leakage and damage to the unit.
- If leaking battery fluid comes in contact with your skin, eyes, or mouth, immediately wash with copious amounts of water, and consult your physician.
- Dead batteries should be removed immediately and disposed of properly, either in a battery collection receptacle or to the appropriate authority.
- Do not attempt to recharge dry batteries.

Never mix new and used batteries, or batteries of different types.

Batteries should last about 1 year under normal use. If the remote controller's operating range becomes appreciably reduced, replace the batteries and press the RESET button with the tip of a ballpoint pen or other small object.

# OPERATION

## To Select Mode Operation

**1 Press the START/STOP button.**  
The indoor unit's OPERATION indicator lamp will light.  
The air conditioner will start operating.

**2 Press the MODE button to select the desired mode.**  
Each time the button is pressed, the mode will change in the following order.



About 3 seconds later, the entire display will reappear.

## To Set the Room Temperature

**Press the SET TEMP. button.**

- ▲ button: Press to raise the thermostat setting.
- ▼ button: Press to lower the thermostat setting.

### ● Thermostat setting range:

AUTO .....	18-30 °C
Cooling/Dry .....	18-30 °C
Heating.....	16-30 °C

The thermostat cannot be used to set room temperature during the FAN mode (the temperature will not appear on the remote controller's display).

About 3 seconds later, the entire display will reappear.

The thermostat setting should be considered a standard value, and may differ somewhat from the actual room temperature.

## To Set the Fan Speed

**Press the FAN button.**

Each time the button is pressed, the fan speed changes in the following order:



About 3 seconds later, the entire display will reappear.

### When set to AUTO:

- Heating** : Fan operates so as to optimally circulate warmed air.  
However, the fan will operate at very low speed when the temperature of the air issued from the indoor unit is low.
- Cooling** : As the room temperature approaches that of the thermostat setting, the fan speed becomes slower.
- Fan** : The fan runs at the low fan speed.

The fan will operate at a very low setting during monitor operation and at the start of the heating mode.

## SUPER QUIET Operation

### When set to QUIET:

SUPER QUIET operation begins. The indoor unit's airflow will be reduced for quieter operation.

- SUPER QUIET operation cannot be used during dry mode. (The same is true when dry mode is selected during AUTO mode operation.)
- During SUPER QUIET operation, heating and cooling performance will be reduced somewhat. If the room does not warm up/ cool down when using SUPER QUIET operation, please adjust the indoor unit's fan speed.

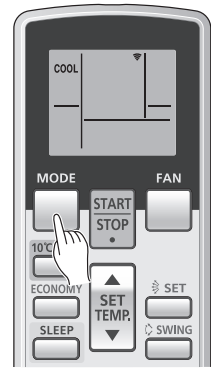

**Example:** When set to COOL.

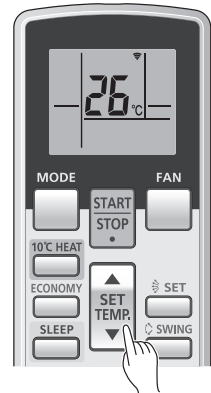

**Example:** When set to 26 °C.

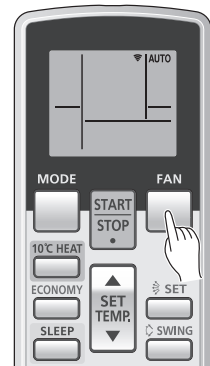

**Example:** When set to AUTO.

# OPERATION

Instructions relating to heating (\*) are applicable only to "HEAT & COOL MODEL" (Reverse Cycle).

## To Stop Operation

**Press the START/STOP button.**

The OPERATION indicator lamp will go out.

## MODE Operation

### AUTO (in COOLING model):

- When AUTO (automatic changeover) operation first selected, the fan will operate at very low speed for about a few minutes, during which time the indoor unit detects the room conditions and selects the proper mode.

Room temperature is higher than the defined temperature in temperature setting → Cooling mode or dry mode

Room temperature is close to or lower than the defined temperature in temperature setting → Monitor operation

- When the indoor unit has adjusted your room's temperature to near the temperature setting, it will begin monitor operation. In the monitor operation mode, the fan will operate at low speed. If the room temperature subsequently changes, the indoor unit will once again select the appropriate operation (cooling) to adjust the temperature to the value set in the temperature setting.
- If the mode automatically selected by the unit is not what you wish, select one of the mode operation (COOL, DRY, FAN).

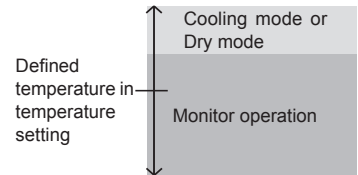

### AUTO [in HEAT & COOL (Reverse Cycle) model]:

- When AUTO (automatic changeover) is selected, the air conditioner selects the appropriate operation mode (cooling or heating) according to your room's present temperature.
- When AUTO (automatic changeover) operation first selected, the fan will operate at low speed for about a few minute, during which time the indoor unit detects the room conditions and selects the proper operation mode.

Room temperature is higher than the defined temperature in temperature setting → Cooling mode or dry mode

Room temperature is close to the defined temperature in temperature setting → Determined by outdoor temperature

Room temperature is lower than the defined temperature in temperature setting → Heating mode

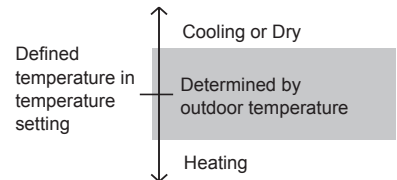

- When the air conditioner has adjusted your room's temperature to near the thermostat setting, it will begin monitor operation. In the monitor operation mode, the fan will operate at low speed. If the room temperature subsequently changes, the air conditioner will once again select the appropriate operation (heating, cooling) to adjust the temperature to the value set in the thermostat.
- If the mode automatically selected by the unit is not what you wish, select one of the mode operation (HEAT, COOL, DRY, FAN).

### HEAT\*:

- Use to warm your room.
- When heating mode is selected, the air conditioner will operate at very low fan speed for about 3 to 5 minutes, after which it will switch to the selected fan setting. This period of time is provided to allow the indoor unit to warm up before beginning full operation.
- When the room temperature is very low, frost may form on the outside unit, and its performance may be reduced. In order to remove such frost, the unit will automatically enter the defrost cycle from time to time. During automatic defrosting operation, the OPERATION indicator lamp will flash, and the heat operation will be interrupted.
- After the start of heating operation, it takes some time before the room gets warmer.

### COOL:

- Use to cool your room.

### DRY:

- Use for gently cooling while dehumidifying your room.
- You cannot heat the room during dry mode.
- During dry mode, the unit will operate at low speed; in order to adjust room humidity, the indoor unit's fan may stop from time to time. Also, the fan may operate at very low speed when adjusting room humidity.
- The fan speed cannot be changed manually when dry mode has been selected.

### FAN:

- Use to circulate the air throughout your room.

#### During heating mode:

Set the thermostat to a temperature setting that is higher than the current room temperature. The heating mode will not operate if the thermostat is set lower than the actual room temperature.

#### During cooling/dry mode:

Set the thermostat to a temperature setting that is lower than the current room temperature. The cooling and dry modes will not operate if the thermostat is set higher than the actual room temperature (in cooling mode, the fan alone will operate).

#### During fan mode:

You can not use the unit to heat and cool your room.



# TIMER OPERATION

Before using the timer function, be sure that the remote controller is set to the correct current time (☞ Page 6.)  
If the indoor unit is connected to a wired remote controller, the wireless remote controller cannot be used to set the timer.

**Note:** In simultaneous multi connection, this function by using the wireless remote controller cannot be used.

## To Use the ON Timer or OFF Timer

**1 Press the START/STOP button.**  
(if the unit is already operating, proceed to step 2).

The indoor unit's OPERATION indicator lamp will light.

**2 Press the TIMER MODE button to select the OFF timer or ON timer operation.**

Each time the button is pressed the timer function changes in the following order:

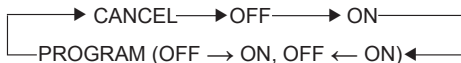

The indoor unit's orange TIMER indicator lamp will light.

**3 Use the TIMER SET buttons to adjust the desired OFF time or ON time.**

Set the time while the time indicator is flashing (the flashing will continue for about 5 seconds).

**[+] button:** Press to advance the time.

**[-] button:** Press to reverse the time.

About 5 seconds later, the entire display will reappear.

### To Cancel the Timer

Use the TIMER button to select "CANCEL".  
The air conditioner will return to normal operation.

### To Change the Timer Settings

Perform steps 2 and 3.

### To Stop Air Conditioner Operation while the Timer is Operating

Press the START/STOP button.

### To Change Operating Conditions

If you wish to change operating conditions (mode, fan speed, thermostat setting, QUIET mode), after making the timer setting wait until the entire display reappears, then press the appropriate buttons to change the operating condition desired.

## To Use the Program Timer

**1 Press the START/STOP button.**  
(if the unit is already operating, proceed to step 2).

The indoor unit's OPERATION indicator lamp will light.

**2 Set the desired times for OFF timer and ON timer.**

See the section "To Use the ON Timer or OFF Timer" to set the desired mode and times.

About 3 seconds later, the entire display will reappear.  
The indoor unit's TIMER indicator lamp will light.

**3 Press the TIMER MODE button to select the PROGRAM timer operation (OFF → ON or OFF ← ON will display).**

The display will alternately show "OFF timer" and "ON timer", then change to show the time setting for the operation to occur first.

- The program timer will begin operation. (If the ON timer has been selected to operate first, the unit will stop operating at this point.)

About 5 seconds later, the entire display will reappear.

### To Cancel the Timer

Use the TIMER MODE button to select "CANCEL".  
The air conditioner will return to normal operation.

### To Change the Timer Settings

1. Follow the instructions given in the section "To Use the ON Timer or OFF Timer" to select the timer setting you wish to change.
2. Press the TIMER MODE button to select either OFF → ON or OFF ← ON.

### To Stop Air Conditioner Operation while the Timer is Operating

Press the START/STOP button.

### To Change Operating Conditions

If you wish to change operating conditions (mode, fan speed, thermostat setting, QUIET mode), after making the timer setting wait until the entire display reappears, then press the appropriate buttons to change the operating condition desired.

## About the Program Timer

- The program timer allows you to integrate OFF timer and ON timer operations in a single sequence. The sequence can involve 1 transition from OFF timer to ON timer, or from ON timer to OFF timer, within a 24 hour period.
- The first timer function to operate will be the 1 set nearest to the current time. The order of operation is indicated by the arrow in the Remote Controller's Display (OFF → ON, or OFF ← ON).
- An example of program timer use might be to have the air conditioner automatically stop (OFF timer) after you go to sleep, then start (ON timer) automatically in the morning before you arise.

# SLEEP TIMER OPERATION

Unlike other timer functions, the SLEEP timer is used to set the length of time until air conditioner operate is stopped. If the indoor unit is connected to a wired remote controller, the wireless remote controller cannot be used to set the sleep timer.

**Note:** In simultaneous multi connection, this function by using the wireless remote controller cannot be used.

## To Use the SLEEP Timer

**While the air conditioner is operating or stopped, press the SLEEP button.**

The indoor unit's OPERATION indicator lamp lights and the TIMER indicator lamp light.

## To Cancel the Timer:

Use the TIMER MODE button to select "CANCEL".

The air conditioner will return to normal operation.

## To Change the Timer Settings

**Press the SLEEP button once again and set the time using the TIMER SET (  $\oplus$  /  $\ominus$  ) buttons.**

## To Stop the Air Conditioner During Timer Operation:

Press the START/STOP button.

$\oplus$  button: Press to advance the time.

$\ominus$  button: Press to reverse the time.

About 5 seconds later, the entire display will reappear.

## About the SLEEP Timer

To prevent excessive warming or cooling during sleep, the SLEEP timer function automatically modifies the thermostat setting in accordance with the set time setting. When the set time has elapsed, the air conditioner completely stops.

### During heating operation:

When the SLEEP timer is set, the thermostat setting is automatically lowered 1 °C every 30 minutes. When the thermostat has been lowered a total of 4 °C, the thermostat setting at that time is maintained until the set time has elapsed, at which time the air conditioner automatically turns off.

#### SLEEP timer setting

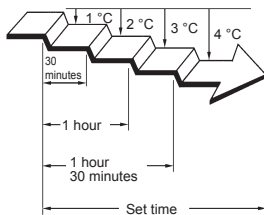

### During cooling/dry operation:

When the SLEEP timer is set, the thermostat setting is automatically raised 1 °C every 1 hour. When the thermostat has been raised a total of 2 °C, the thermostat setting at that time is maintained until the set time has elapsed, at which time the air conditioner automatically turns off.

#### SLEEP timer setting

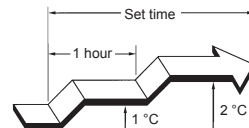

# MANUAL AUTO OPERATION

Perform the MANUAL AUTO operation if you have lost the remote controller or encounter remote control malfunction.

## How To Control the Indoor Unit without Remote Controller

**Press the MANUAL AUTO button more than 3 seconds and less than 10 seconds on the indoor unit.**



To stop operation, press the MANUAL AUTO button once again.

- When the air conditioner is operated with the controls on the indoor unit, it will perform same mode as the AUTO mode selected on the remote controller. However, the heat-pump model in multi-type air conditioner will follow the operating mode of the other indoor unit.
- The fan speed will be set to "AUTO" and the thermostat setting will be at the standard value.

# ADJUSTING THE DIRECTION OF AIR CIRCULATION

Instructions relating to heating (\*) are applicable only to "HEAT & COOL MODEL" (Reverse Cycle).

Begin air conditioner operation before performing this procedure.

## Vertical Air Direction Adjustment

### Press the SET button (Vertical).

Each time the button is pressed, the air direction range will change as follows:



The remote controller's display does not change.

Airflow direction setting:

①, ②, ③, ④: During cooling/heating/dry mode

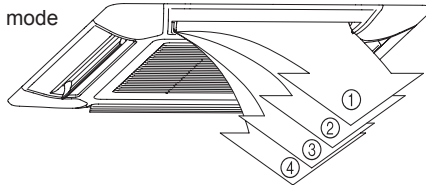

- The vertical airflow direction is set automatically as shown, in accordance with the type of operation selected.

During cooling/dry mode : Horizontal flow ①

During heating mode \* : Downward flow ④

- During AUTO mode operation, for the first minute after beginning operation, airflow will be horizontal ①; the air direction cannot be adjusted during this period.

- Attempting to move up/down air direction flaps manually could result in improper operation; in this case, stop operation and restart. The louvers should begin to operate properly again.
- When used in a room with infants, children, elderly or sick persons, the air direction and room temperature should be considered carefully when making settings.

## Horizontal Air Direction Adjustment

The function cannot be used.

# SWING OPERATION

Begin air conditioner operation before performing this procedure.

## To select SWING Operation

### Press the SWING button

The SWING indicator will light.

In this mode, the airflow direction louvers will swing automatically to direct the air flow both up and down.

## To stop SWING Operation

### Press the SWING button once again.

The SWING indicator will go out.

Airflow direction will return to the setting before swing was begun.

## About SWING Operation

The type of operation	Range of swing
Cooling/Heating/Dry/Fan	① to ④

The SWING operation may stop temporarily when the air conditioner's fan is not operating, or when operating at very low speeds

# ECONOMY OPERATION

Begin air conditioner operation before performing this procedure.

## To Use the ECONOMY Operation

### Press the ECONOMY button.

The ECONOMY indicator lamp (green) will light.  
ECONOMY operation begins.

## To Stop the ECONOMY Operation

### Press the ECONOMY button again.

The ECONOMY indicator lamp (green) will go out.  
Normal operation begins.

## About ECONOMY Operation

At the maximum output, ECONOMY operation is approximately 70% of normal air conditioner operation for cooling and heating.

- If the room is not cooled (or heated) well during ECONOMY operation, select normal operation.
- During the monitor period in the AUTO mode, the air conditioner operation will not change to ECONOMY operation even if ECONOMY operation is selected by pressing the ECONOMY operation button.
- When ECONOMY operation mode is operated, the room temperature will be little higher than the set-temp under cooling mode and lower than set-temp under heating mode. Therefore, the ECONOMY mode is able to save more energy than other normal mode.
- In case of multi-type air conditioner, the ECONOMY operation mode is only available for the set indoor unit.

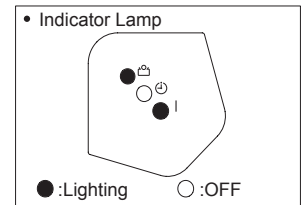

# 10°C HEAT OPERATION

**Note:** In simultaneous multi connection, this function by using the wireless remote controller cannot be used.

## To use 10°C HEAT Operation

### Press the 10°C HEAT button

The OPERATION indicator lamp (green) will go out, and the ECONOMY indicator lamp (green) will light.

## To stop 10°C HEAT Operation

### Press the START/STOP button

Then the operation stops and the ECONOMY indicator lamp (green) will go out.

While 10°C HEAT operation is in progress, only the following operation can be used.

- SET

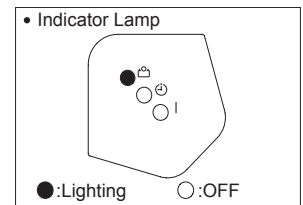

## About the 10°C HEAT Operation

- The heating mode will not operate if the room temperature is high enough.
- The room temperature can be maintained at 10°C by pressing the 10°C HEAT button so as to prevent the room temperature from falling too far.
- In case of multi-type air conditioner, if other indoor unit is used for heating, the temperature of the room where the "10°C HEAT" function is applied will rise. When using the "10°C HEAT" function, we recommend all indoor units should be run under the "10°C HEAT" mode.

# SELECTING THE REMOTE CONTROLLER SIGNAL CODE

When two or more air conditioners are installed in a room and the Remote Controller is operating an air conditioner other than the one you wish to set, change the signal code of the Remote Controller to operate only the air conditioner you wish to set (4 selections possible).

When two or more air conditioners are installed in a room, please contact your retailer to set the individual air conditioner signal codes.

## Selecting the Remote Controller Signal Code

Use the following steps to select the signal code of the remote controller. (Note that the air conditioner cannot receive a signal code if the air conditioner has not been set for the signal code.)

- 1 Press the START/STOP button until only the clock is displayed on the remote controller display.**
- 2 Press the MODE button for at least five seconds to display the current signal code (initially set to **A**).**
- 3 Press the (▲/▼) buttons to change the signal code between **A**→**B**→**C**→**D**. Match the code on the display to the air conditioner signal code.**
- 4 Press the MODE button again to return to the clock display. The signal code will be changed.**

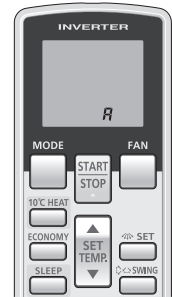

- If no buttons are pressed within 30 seconds after the signal code is displayed, the system returns to the original clock display. In this case, start again from step 1.
  - The air conditioner signal code is set to "A" prior to shipment. Contact your retailer to change the signal code.
  - The Remote Controller resets to signal code "A" when the batteries in the Remote Controller are replaced. If you use a signal code other than signal code "A", reset the signal code after replacing the batteries.
- If you do not know the air conditioner signal code setting, try each of the signal codes (**A**→**B**→**C**→**D**) until you find the code which operates the air conditioner.

# CLEANING AND CARE



## CAUTION

- Before cleaning the unit, be sure to stop the unit and disconnect the power supply.
- Turn off the electrical breaker.
- A fan operates at high speed inside the unit, and personal injury could result.
- Be careful not to drop the intake grille.
- As the filter cleaning involves high-altitude operation, please consult the professional technical service personnel.

- When used for extended periods, the unit may accumulate dirt inside, reducing its performance. We recommend that the unit be inspected regularly, in addition to your own cleaning and care. For more information, consult authorized service personnel.
- When cleaning the unit's body, do not use water hotter than 40 °C, harsh abrasive cleansers, or volatile agents like benzene or thinner.
- Do not expose the unit body to liquid insecticides or hairsprays.
- If the unit will not be operated for a period of 1 month or more, be sure to allow the inner parts of the unit to dry thoroughly, in advance, by operating the unit in fan mode for half a day.

## Cleaning the Air Filter

1. Push the intake grille's hooks inward towards the center of the unit to open the intake grille.

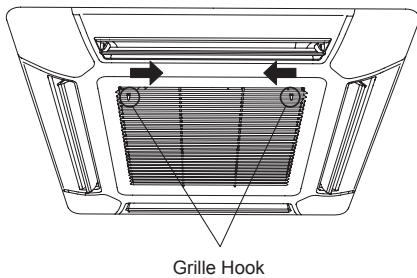

2. Pull out the filter from the intake grille.

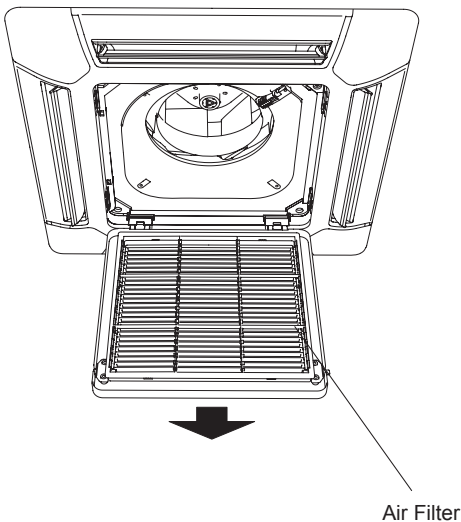

3. Clean the air filters.

Remove the dust from the air filters by vacuuming or washing them. After washing, allow the air filters to dry thoroughly in an area protected from sunlight.

4. Re-attach the air filters to the intake grille.

- ① Replace the air filter into its holder.
- ② Make sure that the air filter makes contact with the filter stopper when it is replaced into its holder.

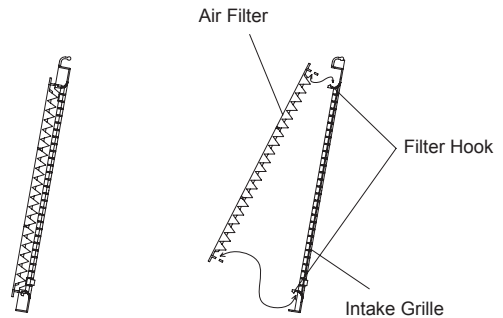

5. Close the intake grille and push the intake grille's hooks outward.

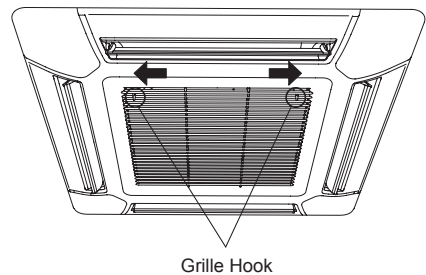

- Dust can be cleaned from the air filter either with a vacuum cleaner, or by washing the filter in a solution of mild detergent and warm water. If you wash the filter, be sure to allow it to dry thoroughly in a shady place before reinstalling.
- If dirt is allowed to accumulate on the air filter, air flow will be reduced, lowering operating efficiency and increasing noise.

# CLEANING AND CARE

## Filter Reset (ECONOMY indicator lamp flashing/ A special setting)

- Can be used if set correctly during installation.  
Please consult authorized service personnel when using this function.

- It lights on when it is time to clean the air filters.

After turning the power on, press the MANUAL AUTO button for 2 seconds or less on the indoor unit.

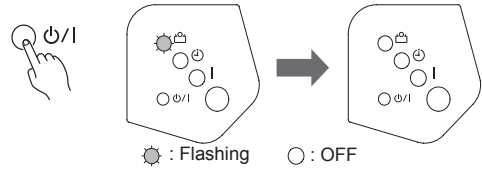

## TROUBLESHOOTING

Instructions relating to heating (\*) are applicable only to "HEAT & COOL MODEL" (Reverse Cycle).



### WARNING

In the event of a malfunction (burning smell, etc.), immediately stop operation, disconnect the power supply plug or turn off the circuit breaker, and consult authorized service personnel. Merely turning off the unit's power switch will not completely disconnect the unit from the power source. Always be sure to disconnect the power supply plug or turn off your circuit breaker to ensure that power is completely off.

Before requesting service, perform the following checks:

	Symptom	Problem	See Page
NORMAL FUNCTION	Does not operate immediately:	<ul style="list-style-type: none"> <li>● If the unit is stopped and then immediately started again, the compressor will not operate for about 3 minutes, in order to prevent fuse blowouts.</li> <li>● Whenever the power supply plug is disconnected and then reconnected to a power outlet, the protection circuit will operate for about 3 minutes, preventing unit operation during that period.</li> </ul>	—
	Noise is heard:	<ul style="list-style-type: none"> <li>● During operation and immediately after stopping the unit, the sound of water flowing in the air conditioner's piping may be heard. Also, noise may be particularly noticeable for about 2 to 3 minutes after starting operation (sound of coolant flowing).</li> <li>● During operation, a slight squeaking sound may be heard. This is the result of minute expansion and contraction of the front panel due to temperature changes.</li> </ul>	—
		*● During heating operation, a sizzling sound may be heard occasionally. This sound is produced by the automatic defrosting operation.	17
	Smells:	<ul style="list-style-type: none"> <li>● Some smell may be emitted from the indoor unit. This smell is the result of room smells (furniture, tobacco, etc.) which have been taken into the indoor unit.</li> </ul>	—
	Mist or steam are emitted:	<ul style="list-style-type: none"> <li>● During cooling or dry operation, a thin mist may be seen emitted from the indoor unit. This results from the sudden cooling of room air by the cool air emitted from the indoor unit, resulting in condensation and misting.</li> </ul>	—
		*● During heating operation, the outdoor unit's fan may stop, and steam may be seen rising from the unit. This is due to the automatic defrosting operation.	17
	Airflow is weak or stops:	*● When heating operation is started, fan speed is temporarily very low, to allow internal parts to warm up.	—
		*● During heating operation, if the room temperature rises above the thermostat setting, the outdoor unit will stop, and the indoor unit will operate at very low fan speed. If you wish to warm the room further, set the thermostat to a higher setting.	—
		*● During heating operation, the unit will temporarily stop operation (between 4 and 15 minutes) as the automatic defrosting mode operates. During the automatic defrosting operation, the OPERATION indicator lamp will flash.	17
		● The fan may operate at very low speed during dry operation or when the unit is monitoring the room's temperature.	—
		● During SUPER QUIET operation, the fan will operate at very low speed.	—
		● In the monitor AUTO operation, the fan will operate at very low speed.	—
● In case of multi-type unit, if multiple units are operated in different operation modes as shown below, the units operated afterward will stop and the OPERATION indicator lamp (green) will flash. <ul style="list-style-type: none"> <li>• Heating mode and cooling mode (or dry mode)</li> <li>• Heating mode and fan mode</li> </ul>	18		

# TROUBLESHOOTING

Instructions relating to heating (\*) are applicable only to "HEAT & COOL MODEL" (Reverse Cycle).

	Symptom	Problem	See Page
NORMAL FUNCTION	Water is produced from the outdoor unit:	*● During heating operation, water may be produced from the outdoor unit due to the automatic defrosting operation.	17
	The ECONOMY indicator lamp flashing.	● Clean the filter. Afterwards, turn the ECONOMY lamp off.	15
CHECK ONCE MORE	Does not operate at all:	● Has the circuit breaker been turned off? ● Has there been a power failure? ● Has a fuse blown out, or a circuit breaker been tripped?	—
		● Is the timer operating?	9 to 10
	Poor Cooling (or Heating*) performance:	● Is the air filter dirty? ● Are the air conditioner's intake grille or outlet port blocked? ● Did you adjust the room temperature settings (thermostat) correctly? ● Is there a window or door open? ● In the case of cooling operation, is a window allowing bright sunlight to enter? (close the curtains.) ● In the case of cooling operation, are there heating apparatus and computers inside the room, or are there too many people in the room?	—
		● Is the unit set for QUIET operation?	—
The unit operates differently from the remote controller's setting:	● Are the remote controller's batteries dead? ● Are the remote controller's batteries loaded properly?	6	

If the problem persists after performing these checks, or if you notice burning smells, or the OPERATION indicator lamp and the TIMER indicator lamp flashes, and ECONOMY indicator lamp flashes fast. Immediately stop operation, turn off the electrical breaker and consult authorized service personnel.



# OPERATING TIPS

Instructions relating to heating (\*) are applicable only to "HEAT & COOL MODEL" (Reverse Cycle).

## Heating Performance\*

- This air conditioner operates on the heat-pump principle, absorbing heat from outdoor air and transferring that heat indoors. As a result, the operating performance is reduced as outdoor air temperature drops. If you feel that insufficient heating performance is being produced, we recommend you use this air conditioner in conjunction with another type of heating appliance.
- Heat-pump air conditioners heat your entire room by recirculating air throughout the room, with the result that some time may be required after first starting the air conditioner until the room is heated.

## When Indoor and Outdoor Temperature are High\*

When both indoor and outdoor temperatures are high during use of the heating mode, the outdoor unit's fan may stop at times.

## Microcomputer-controlled Automatic Defrosting\*

- When using the heating mode under conditions of low outdoor temperature and high humidity, frost may form on the outdoor unit, resulting in reduced operating performance.  
In order to prevent this kind of reduced performance, this unit is equipped with a microcomputer-controlled automatic defrosting function. If frost forms, the air conditioner will temporarily stop, and the defrosting circuit will operate briefly (for about 4 to 15 minutes).  
During automatic defrosting operation, the OPERATION indicator lamp will flash.
- After heating operation stops, if frost forms on the outdoor unit, the unit will start automatic defrosting operation. At this time, the outdoor unit will automatically stop after operating for a few minutes.  
(However, some type of multi-type air conditioner doesn't provide this function.)

## Low Ambient Cooling\*

When the outdoor temperature drops, the outdoor unit's fans may switch to low speed, or one of the fans may stop intermittently.

## Dual Remote Controllers (optional)

An additional remote controller can be added up to the maximum of 2 remote controllers. Either remote controller can control the air conditioner. However, the timer functions cannot be used at the secondary unit.

## Group Control

1 remote controller can control up to 16 air conditioners. All of the air conditioners will be operated with the same settings.

**Group control cannot be used when using it by the multi type.**

## AUTO Restart

### In Event of Power Interruption

- Should the power supply to the air conditioner be interrupted by a power failure, the air conditioner will restart automatically in the previously selected mode once the power is restored.
- Should a power failure occur during TIMER operation, the timer will be reset and the unit will begin (or stop) operating under the new timer setting. In this event, the TIMER indicator lamp will flash.
- Use of other electrical appliances (electric shaver, etc.) or nearby use of a wireless radio transmitter may cause the air conditioner to malfunction. In this event, temporarily disconnect the power supply plug, reconnect it, and then use the remote controller to resume operation.

# OPERATING TIPS

## Multi-type Air Conditioner

This indoor unit can be connected to a multi-type outdoor unit. The multi-type air conditioner allows multiple indoor units to be operated in multiple locations. The indoor units may be operated simultaneously, in accordance with their respective output.

### Simultaneous Use of Multiple Units

Instructions relating to inverter (\*) are applicable only to "INVERTER MODEL".

- When using a multi-type air conditioner, the multiple indoor units can be operated simultaneously, but when 2 or more indoor units of the same group are operated simultaneously, the heating and cooling efficiency will be less than when a single indoor unit is used alone. Accordingly, when you wish to use more than 1 indoor unit for cooling at the same time, the use should be concentrated at night and other times when less output is required. In the same way, when multiple units are used simultaneously for heating, it is recommended that they be used in conjunction with other auxiliary space heaters, as required.
- Seasonal and outdoor temperature conditions, the structure of the rooms and the number of persons present may also result in differences of operating efficiency. We recommend that you try various operating patterns in order to confirm the level of heating and cooling output provided by your units, and use the units in the way that best matches your family's lifestyle.
- If you discover that 1 or more units delivers a low level of cooling or heating during simultaneous operation, we recommend that you stop simultaneous operation of the multiple units.
- \*● Operation cannot be done in the following different operating modes.
  - If the indoor unit is instructed to do an operating mode that it cannot perform, the OPERATION indicator lamp on the indoor unit will flash (1 second on, 1 second off) and the unit will go into the standby mode.
    - Heating mode and cooling mode (or dry mode)
    - Heating mode and fan mode
- \*● Operation can be done in the following different operating modes.
  - Cooling mode and dry mode
  - Cooling mode and fan mode
  - Dry mode and fan mode
- \*● The operating mode (heating mode or cooling (dry) mode) of the outdoor unit will be determined by the operating mode of the indoor unit that was operated first. If the indoor unit was started in fan mode, the operating mode of the outdoor unit will not be determined.
  - For example, if indoor unit (A) was started in fan mode and then indoor unit (B) was then operated in heating mode, indoor unit (A) would temporarily start operation in fan mode but when indoor unit (B) started operating in heating mode, the OPERATION indicator lamp for indoor unit (A) would begin to flash (1 second on, 1 second off) and it would go into standby mode. Indoor unit (B) would continue to operate in heating mode.

## Simultaneous Multi Air Conditioner

This indoor unit can also be connected to a simultaneous multi connection that enables simultaneous operation of up to 3 indoor units with connecting the outdoor unit by using a separation tube (twin or triple).

**Note:** Connectable type of the separation tube varies by model.

In simultaneous multi connection, all the indoor units perform simultaneous air conditioning controlled by one controller that is specified as the primary control unit.

For this unique characteristic of the simultaneous multi connection, some of the functions controlled by the controller that is specified as the secondary control unit are restricted.

## Notices

Instructions relating to heating (\*) are applicable only to "HEAT & COOL MODEL" (Reverse Cycle).

- \*● During use of the heating mode, the outdoor unit will occasionally commence the defrost operation for brief periods. During the defrosting operation, if the user sets the indoor unit for heating again, the defrosting mode will continue, and the heating operation will begin after completion of defrosting, with the result that some time may be required before warm air is emitted.
- \*● During use of the heating mode, the top of the indoor unit may become warm, but this is due to the fact that coolant is circulated through the indoor unit even when it is stopped; it is not a malfunction.