

## OPERATING MANUAL

**AIR CONDITIONER**

OPERATING MANUAL  
BEDIENUNGSANLEITUNG  
MODE D'EMPLOI  
MANUAL DE FUNCIONAMIENTO  
MANUALE DI ISTRUZIONI  
ΕΓΧΕΙΡΙΔΙΟ ΛΕΙΤΟΥΡΓΙΑΣ

Indoor Unit

### CEILING SUSPENSION TYPE

ABG30TF  MF  
ABG36TF  MF  
ABG45TF  MF  
ABG54TF  MF

### FLOOR CONSOLE/UNDER CEILING DUAL TYPE

ABG12TF  MF  
ABG14TF  MF  
ABG18TF  MF  
ABG24TF  MF

### DUCT TYPE

ARG7TF  MF  
ARG9TF  MF  
ARG12TF  MF  
ARG14TF  MF  
ARG18TF  MF  
ARG25TF  MF  
ARG30TF  MF  
ARG36TF  MF  
ARG45TF  MF  
ARG60TF  MF

### CASSETTE TYPE

AUG7TF  MF  
AUG9TF  MF  
AUG12TF  MF  
AUG14TF  MF  
AUG18TF  MF  
AUG20TF  MF  
AUG25TF  MF  
AUG36TF  MF  
AUG45TF  MF  
AUG54TF  MF

### WALL MOUNTED TYPE

ASG14TF  MF  
ASG20TF  MF  
ASG24TF  MF  
ASG30TF  MF

Outdoor Unit

AOG90TP  MF

Remote Control Unit

UTB-GLA

English

Deutsch

Français

Español

Italiano

Ελληνικά



KEEP THIS OPERATION MANUAL  
FOR FUTURE REFERENCE

# CONTENTS

SAFETY PRECAUTIONS .....	1	ADJUSTING THE DIRECTION OF AIR CIRCULATION .....	17
FEATURES AND FUNCTIONS .....	2	SWING OPERATION .....	18
NAME OF PARTS .....	2	SYSTEM OPERATION .....	20
PREPARATION .....	7	ERRORS AND SELF DIAGNOSIS .....	21
OPERATION .....	8	CLEANING AND CARE .....	22
TIMER OPERATION (OFF TIMER/ON TIMER) ....	10	TROUBLESHOOTING .....	27
TIMER OPERATION (WEEKLY TIMER) .....	11	OPERATING TIPS .....	28
ENERGY SAVE OPERATION .....	16	SPECIFICATIONS .....	30

## SAFETY PRECAUTIONS

- Before using the appliance, read these "PRECAUTIONS" thoroughly and operate in the correct way.
- The instructions in this section all relate to safety; be sure to maintain safe operating conditions.
- "DANGER", "WARNING" and "CAUTION" have the following meanings in these instructions:

 <b>DANGER!</b>	This mark indicates procedures which, if improperly performed, are most likely to result in the death of or serious injury to the user or service personnel.
 <b>WARNING!</b>	This mark indicates procedures which, if improperly performed, might lead to the death or serious injury of the user.
 <b>CAUTION!</b>	This mark indicates procedures which, if improperly performed, might possibly result in personal harm to the user, or damage to property.

### **DANGER!**

- Do not attempt to install this air conditioner by yourself.
- This unit contains no user-serviceable parts. Always consult authorized service personnel for repairs.
- When moving, consult authorized service personnel for disconnection and installation of the unit.
- Do not become over-exposed to cold air by staying in the direct path of the airflow of the air conditioner for extended periods of time.
- Do not insert fingers or objects into the outlet port or intake grilles.
- Do not start and stop air conditioner operation by turning off the electrical breaker and so on.
- In the event of a malfunction (burning smell, etc.), immediately stop operation, turn off the electrical breaker, and consult authorized service personnel.

### **CAUTION!**

- Provide occasional ventilation during use.
- Do not direct air flow at fireplaces or heating apparatus.
- Do not climb on, or place objects on, the air conditioner.
- Do not hang objects from the indoor unit.
- Do not set flower vases or water containers on top of air conditioners.
- Do not expose the air conditioner directly to water.
- Do not operate the air conditioner with wet hands.
- Turn off power source when not using the unit for extended periods.
- Always turn off the electrical breaker whenever cleaning the air conditioner or the air filter.
- Connection valves become hot during Heating; handle with care.
- Check the condition of the installation stand for damage.
- Do not place animals or plants in the direct path of the air flow.
- When restarting after a long period of disuse in the winter, do:  
Turn the power switch on at least 12 hours before starting the unit.
- Do not drink the water drained from the air conditioner.
- Do not use in applications involving the storage of foods, plants or animals, precision equipment, or art works.
- Do not apply any heavy pressure to radiator fins.
- Operate only with air filters installed.
- Do not block or cover the intake grille and outlet port.
- Ensure that any electronic equipment is at least one metre away from either the indoor or outdoor units.
- Avoid installing the air conditioner near a fireplace or other heating apparatus.
- When installing the indoor and outdoor unit, take precautions to prevent access to infants.
- Do not use inflammable gases near the air conditioner.

# FEATURES AND FUNCTIONS

## AUTOMATIC OPERATION

### ● COOLING MODEL

Merely press the START/STOP button, and the unit will begin automatic operation in the Cooling or Dry mode as appropriate, in accordance with the thermostat setting and the actual temperature of the room.

### ● HEAT RECOVERY MODEL

Merely press the START/STOP button, and the unit will begin automatic operation in either the Heating, Cooling or Monitor modes as appropriate, in accordance with the thermostat setting and the actual temperature of the room.

## WEEKLY TIMER FEATURES

- Set different operating times for each day of the week.
- Set one or two operating spans (one or two ON times and one or two OFF times) per day.
- Set time to a resolution of 5 minutes.
- OFF time can be carried over to the subsequent day.
- Use the "DAY OFF" setting to cancel operation for any day of the coming week (one-time cancellation).

## NAME OF PARTS

### ■ CEILING SUSPENSION TYPE

Fig. 1

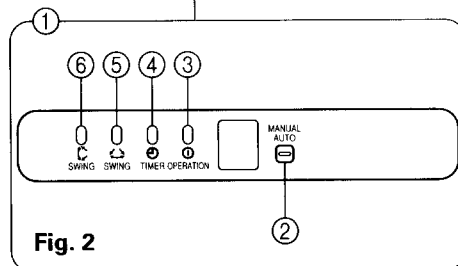
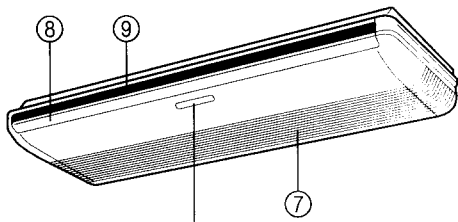

Fig. 1 Indoor Unit

- ① Operating Control Panel (Fig. 2)
- ② MANUAL AUTO button
- ③ OPERATION Indicator Lamp (red)
- ④ TIMER Indicator Lamp (green)
- ⑤ SWING Indicator Lamp (orange) (HORIZONTAL SWING)
- ⑥ SWING Indicator Lamp (orange) (VERTICAL SWING)
- ⑦ Intake Grille
- ⑧ UP/DOWN Air Direction Flap
- ⑨ RIGHT/LEFT Air Direction Louvers (behind UP/DOWN Air Direction Flap)

### ■ FLOOR CONSOLE/ UNDER CEILING DUAL TYPE

Fig. 3

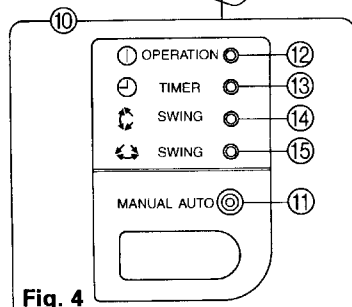
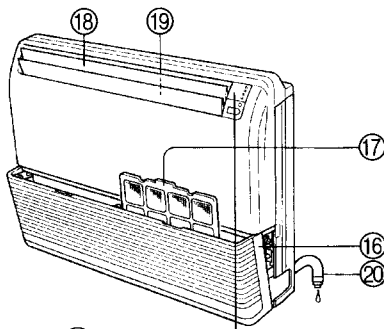

Fig. 3 Indoor Unit

- ⑩ Operating Control Panel (Fig. 4)
- ⑪ MANUAL AUTO button
- ⑫ OPERATION Indicator Lamp (red)
- ⑬ TIMER Indicator Lamp (green)
- ⑭ SWING Indicator Lamp (orange) (VERTICAL SWING)
- ⑮ SWING Indicator Lamp (orange) (HORIZONTAL SWING)
- ⑯ Intake Grille
- ⑰ Air Filter
- ⑱ UP/DOWN Air Direction Flaps
- ⑲ RIGHT/LEFT Air Direction Louvers (behind UP/DOWN Air Direction Flaps)
- ⑳ Drain Hose

# NAME OF PARTS

## ■ DUCT TYPE (Compact)

Fig. 5

### ● Ceiling Concealed

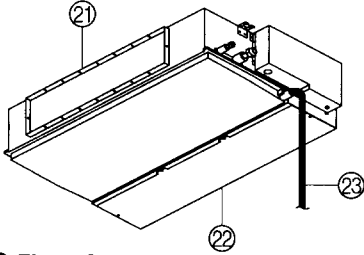

### ● Floor Standing Concealed

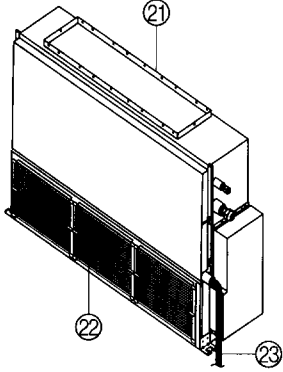

Fig. 5 Indoor Unit

- ① Outlet Port
- ② Intake Port
- ③ Drain Hose

## ■ DUCT TYPE (Low pressure)

Fig. 6

### ● Square Flange

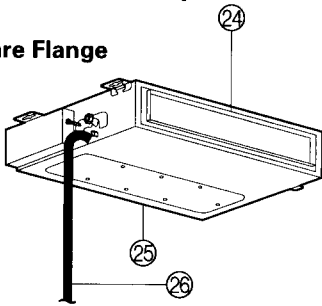

### ● Round Flange

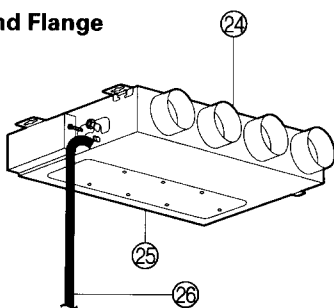

Fig. 6 Indoor Unit

- ④ Outlet Port
- ⑤ Intake Port
- ⑥ Drain Hose

## ■ DUCT TYPE (High pressure)

Fig. 7

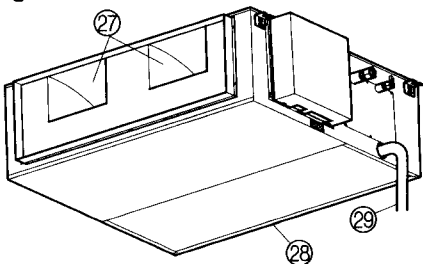

Fig. 7 Indoor Unit

- ⑦ Outlet Port
- ⑧ Intake Port
- ⑨ Drain Hose

■ CASSETTE TYPE (Compact)

Fig. 8

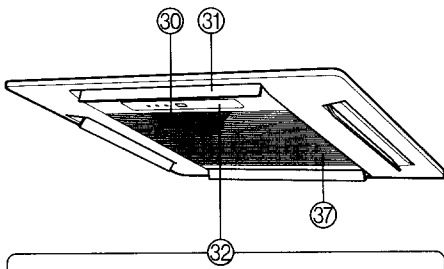

Fig. 9

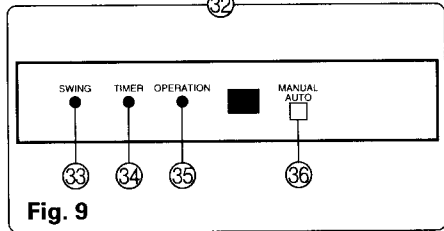

Fig. 8 Indoor Unit

- ③① Air Filter
- ③① Air Flow Direction Flaps
- ③② Indicator Lamps (Fig. 9)
- ③③ SWING Indicator Lamp (orange)
- ③④ TIMER Indicator Lamp (green)
- ③⑤ OPERATION Indicator Lamp (red)
- ③⑥ MANUAL AUTO Button
- ③⑦ Air Intake Grille

■ CASSETTE TYPE

Fig. 10

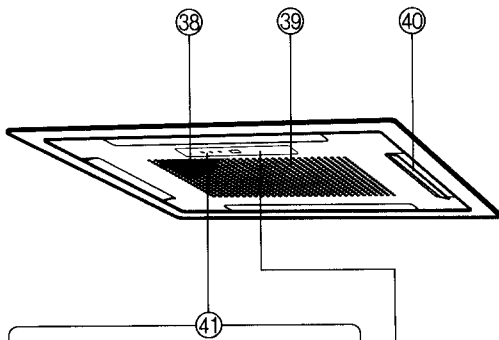

Fig. 11

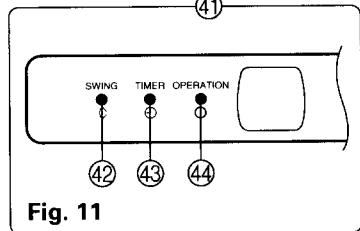

Fig. 12

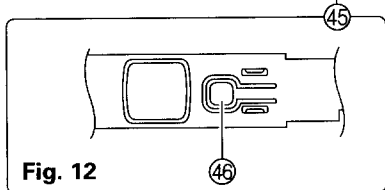

Fig. 10 Indoor Unit

- ③⑧ Air Filter
- ③⑨ Air Intake Grille
- ④① Air Flow Direction Flaps
- ④① Indicator Lamps (Fig. 11)
- ④② SWING Indicator Lamp (orange)
- ④③ TIMER Indicator Lamp (green)
- ④④ OPERATION Indicator Lamp (red)
- ④⑤ Operating Control Panel (Fig. 12)
- ④⑥ MANUAL AUTO Button

Fig. 17



Fig. 17 Outdoor Unit

- ⑥① Intake Port
- ⑥② Outlet Port

Electrical Breaker



Fig. 18

This breaker is installed during the electrical installation.

Fig. 19

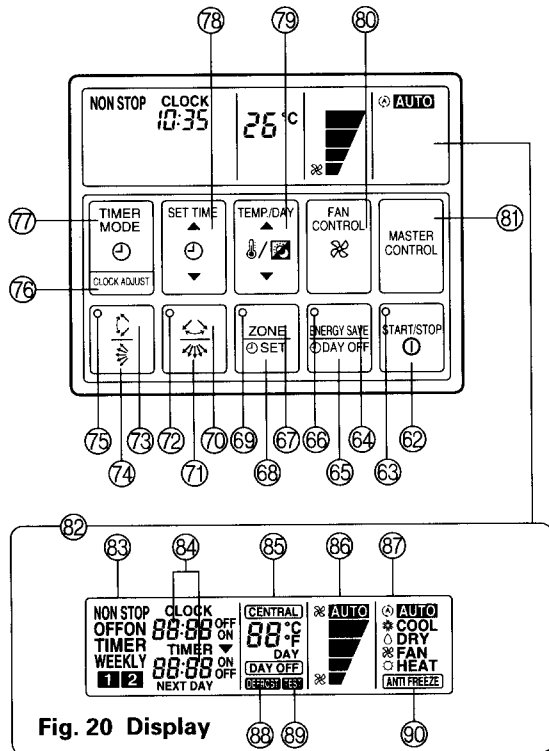

Fig. 19 Remote Controller

- ⑥② START/STOP Button
- ⑥③ Operation Lamp
- ⑥④ ENERGY SAVE Button
- ⑥⑤ DAY OFF Button
- ⑥⑥ ENERGY SAVE Lamp
- ⑥⑦ ZONE CONTROL Button
- ⑥⑧ SET Button
- ⑥⑨ ZONE CONTROL Lamp
- ⑦① HORIZONTAL SWING Button
- ⑦② HORIZONTAL SWING Lamp
- ⑦③ VERTICAL SWING Button
- ⑦④ VERTICAL AIR FLOW DIRECTION SET Button
- ⑦⑤ VERTICAL SWING Lamp
- ⑦⑥ CLOCK ADJUST Button
- ⑦⑦ TIMER MODE Button
- ⑦⑧ SET TIME Button
- ⑦⑨ SET TEMP./DAY Button
- ⑧① FAN CONTROL Button
- ⑧② MASTER CONTROL Button

Fig. 20 Display

For explanatory purposes, the figure showing the remote controller display shows all possible displays. The actual display shows only that area that is being adjusted or used.

- ⑧③ Remote Controller Display (Fig. 20)
- ⑧④ Timer Mode Display
- ⑧⑤ Clock Display (CLOCK/TIMER)
- ⑧⑥ Set Temperature Display (TEMP.)
- ⑧⑦ Fan Speed Display
- ⑧⑧ Operation Mode Display
- ⑧⑨ DEFROST Display
- ⑧⑩ TEST Display
- ⑧⑪ ANTI FREEZE Display

# PREPARATION

## Set the Current Time and Day

**1** Press the **CLOCK ADJUST** button for more than three seconds.

**2** Press the **SET TEMP./DAY** button and set the day.

▲: Use to advance the day forward.

▼: Use to turn the day back.

The day is indicated by a code number from 1 to 7, as shown in the table below. Set to the number that corresponds to the current day.

DAY CODE	1	2	3	4	5	6	7
DAY OF THE WEEK	MON	TUE	WED	THU	FRI	SAT	SUN

**3** Press the **SET TIME** button and set the time.

▲: Use to advance the time forward.

▼: Use to turn the time back.

(Press once to move the time 1 minute; hold down and the time will move 10 minutes at a time.)

**4** Press the **CLOCK ADJUST** button again.

This registers the new day and time values. The day display goes off, and the time display stops flashing.

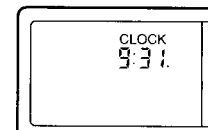
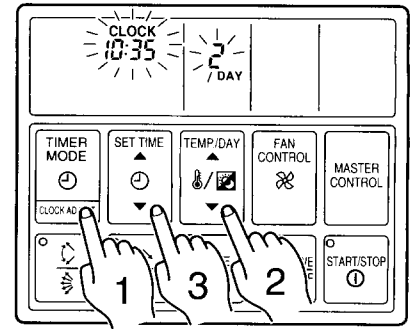

**Example:** Set the time to 9:31.

# OPERATION

Instructions relating to heating(\*) are applicable only to "HEAT & COOL MODEL" (Reverse Cycle).

Instructions relating to "the indoor unit's indicator lamp" (\*\*) are applicable to "CEILING SUSPENSION TYPE", "FLOOR CONSOLE/UNDER CEILING DUAL TYPE", "CASSETTE TYPE" and "WALL MOUNTED TYPE".

## To Select Mode Operation

- 1 Press the START/STOP button.**  
The unit will start and the remote controller's operation lamp (green) and \*\*the indoor unit's OPERATION indicator lamp (red) will light up.
- 2 Press the MASTER CONTROL button to select the desired mode.**

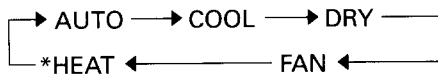

AUTO and FAN cannot be used on "HEAT & COOL MODEL" with no setting for AUTO CHANGEOVER.

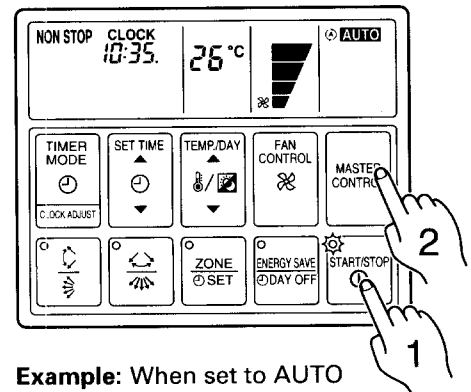

Example: When set to AUTO

## To Set the Thermostat

Press the SET TEMP./DAY button to the desired temperature.

- ▲ : Press to raise the thermostat setting.
- ▼ : Press to lower the thermostat setting.

### ● Thermostat setting range:

- AUTO ..... 18 to 30 °C
- \* Heating ..... 16 to 30 °C
- Cooling/Dry ..... 18 to 30 °C

The thermostat cannot be used to set room temperature during the FAN mode (the temperature will not appear on the remote controller's display).

The thermostat setting should be considered a standard value, and may differ somewhat from the actual room temperature.

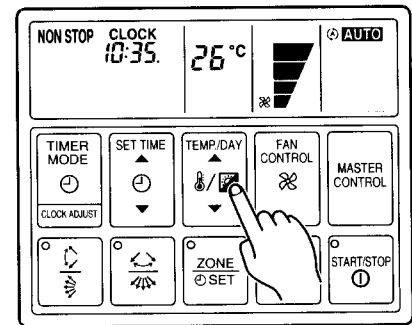

Example: When set to 26 °C

## To Set the Fan Speed

Press the FAN CONTROL button to select the fan speed.

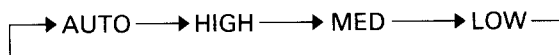

### When set to AUTO:

- \* Heating** : Fan operates so as to optimally circulate warmed air. However, the fan will operate at very low speed when the temperature of the air issued from the indoor unit is low.
- Cooling** : As the room temperature approaches that of the thermostat setting, the fan speed becomes slower.
- Fan** : The fan alternately turns on and off; when on, the fan runs at the low fan speed.

The fan will operate at a very low setting during Monitor operation.

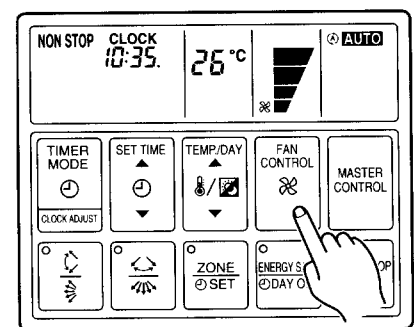

Example: When set to HIGH

## To Stop Operation

Press the START/STOP button.

\*\*The OPERATION indicator lamp (red) will go out.

The remote controller's operation lamp (green) will go out.  
The display contents disappear and only the current time is displayed.



# OPERATION

Instructions relating to heating(\*) are applicable only to "HEAT & COOL MODEL" (Reverse Cycle).

Instructions relating to "the indoor unit's indicator lamp" (\*\*) are applicable to "CEILING SUSPENSION TYPE", "FLOOR CONSOLE/UNDER CEILING DUAL TYPE", "CASSETTE TYPE" and "WALL MOUNTED TYPE".

## About Mode Operation

### AUTO:

#### COOLING MODEL

- When the room temperature is 2 °C higher than the set temperature, the mode will switch between Cooling and Drying.
- During the Drying mode operation, the FAN setting should be switched to LOW for a gently cooling effect during which the fan may temporarily stop rotating.
- If the mode automatically selected by the unit is not satisfactory, see page 8 for instructions on changing the mode setting (COOL, FAN).

#### AUTO (\* AUTO CHANGEOVER):

##### HEAT RECOVERY MODEL

- When AUTO CHANGEOVER is selected, the air conditioner selects the appropriate operation mode (Cooling or Heating) according to your room's present temperature.
- When AUTO CHANGEOVER is first selected, the fan will operate at very low speed for about one minute while the unit determines the current conditions of the room and accordingly selects the proper operation mode.
- When the air conditioner has adjusted your room's temperature to near the thermostat setting, it will begin monitor operation. In the monitor operation mode, the fan will operate at low speed. If the room temperature subsequently changes, the air conditioner will once again select the appropriate operation (Heating, Cooling) to adjust the temperature to the value set in the thermostat. (The monitor operation range is  $\pm 2$  °C relative to the thermostat setting.)
- If the mode automatically selected by the unit is not satisfactory, see page 8 for instructions on changing the mode setting (HEAT, COOL, FAN).

#### \* Heating:

- Use to warm your room.
- When Heating mode is selected, the air conditioner will operate at very low fan speed for about 3 to 5 minutes, after which it will switch to the selected fan setting. This period of time is provided to allow the indoor unit to warm up before begin full operation.
- When the room temperature is very low, frost may form on the outside unit, and its performance may be reduced. In order to remove such frost, the unit will automatically enter the defrost cycle from time to time. During defrosting (see page 28), the heating mode will be temporarily interrupted. **DEFROST** will be shown on the remote controller display \*\*and indoor unit's OPERATION indicator lamp (red) will flash.

#### Cooling:

- Use to cool your room.

#### Fan:

- Use to circulate the air throughout your room.

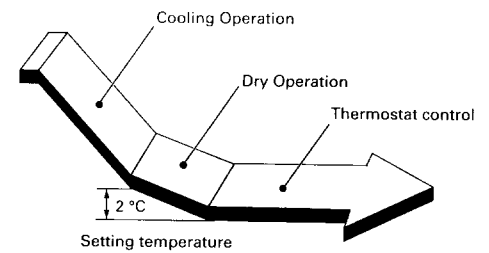

#### \* During Heating mode:

Set the thermostat to a temperature setting that is higher than the current room temperature. The Heating mode will not operate if the thermostat is set lower than the actual room temperature.

#### During Cooling mode:

Set the thermostat to a temperature setting that is lower than the current room temperature. The Cooling mode will not operate if the thermostat is set higher than the actual room temperature (in Cooling mode, the fan alone will operate).

# TIMER OPERATION (OFF TIMER/ON TIMER)

Instructions relating to heating(\*) are applicable only to "HEAT & COOL MODEL" (Reverse Cycle).

Instructions relating to "the indoor unit's indicator lamp" (\*\*) are applicable to "CEILING SUSPENSION TYPE", "FLOOR CONSOLE/UNDER CEILING DUAL TYPE", "CASSETTE TYPE" and "WALL MOUNTED TYPE".

Before using the timer function, be sure that the remote controller is set to the correct current time and Day.

Press the START/STOP button; after the unit starts operation perform the following procedure:

## OFF Timer / ON Timer

### 1 Press the TIMER MODE button and display either OFF Timer or ON Timer.

The timer will start operating. (If you set the ON timer, the air conditioner will stop operating.)

Each time the button is pressed the timer function changes in the following order:

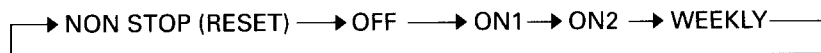

\*\*The indoor unit's TIMER indicator lamp (green) will light up.

### 2 Press the SET TIME button and set the timer time.

▲ : Use to advance the time forward.

▼ : Use to turn the time back.

(Press once to move the time 1 minute; hold down and the time will move 10 minutes at a time.)

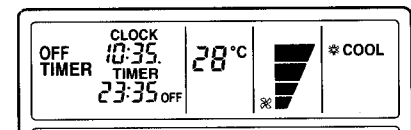
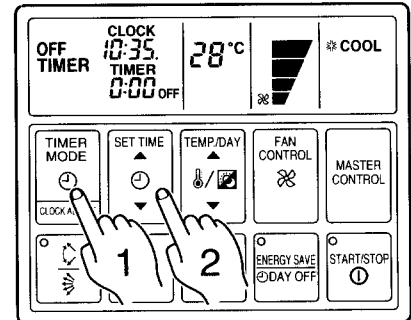

**Example:** Setting the OFF TIMER to 23:35

#### To Confirm or Change Settings Before Starting Operation

- **To confirm settings**  
Press the TIMER MODE button once. (The timer setting information will be displayed for 15 seconds after the TIMER MODE button is pressed.)
- **To change settings**  
Confirm the settings as noted above, then press the SET TIME button and TIMER MODE button as necessary to change the desired timer setting. (The timer settings will be displayed for 15 seconds after the button is pressed.)
- After confirming or changing the settings, press the START/STOP button to start operation.

#### About the ON TIMER1

- When the set time is reached, the mode that has been set will begin to operate.

#### To Change the Timer Setting During Operation

Operate as noted in step 2.

#### To Change the Timer Mode During Operation

Press the TIMER MODE button and set the unit to the desired mode.

#### To Cancel the Timer Mode During Timer Operation

Press the TIMER MODE button and set the display to "NON STOP" (the unit will switch to non-stop operation).

#### To Stop Operation During Use of Timer Mode

Press the START/STOP button.

#### About the ON TIMER2

- The timer function is designed to bring your room to a comfortable temperature by the set time; as a result, the unit automatically begins operation before the set time so that the room reaches the desired temperature by the time set on the timer ("Favorite temperature timer").
- The hotter it is in summer, or the colder it is in winter, the earlier that operation will begin.
  - \* During Heating Operation
    - ... from 45 to 10 minutes before set time.
  - During Cooling/Dry Operation
    - ... from 20 to 10 minutes before set time.
  - During Fan Operation
    - ... at the set time.

# TIMER OPERATION (WEEKLY TIMER)

Use the weekly timer to set operating times for each day of the week.

## Weekly Timer Features

- Set different operating times for each day of the week.
- Set one or two operating spans (one or two ON times and one or two OFF times) per day.
- Set time to a resolution of 5 minutes.
- OFF time can be carried over to the subsequent day.
- Use the "DAY OFF" setting to cancel operation for any day of the coming week (one-time cancellation).

## Setting Up the Weekly Timer Operation

Press the START/STOP button to stop the air conditioner, and then proceed as follows.

### 1 Press the TIMER MODE button so that "WEEKLY" appears on the display.

The display now shows the current day (by DAY CODE), the first ON and OFF times for the day (the "WEEKLY 1" times), the fan speed, and the operating mode.

The top time value gives the ON time, and the bottom value gives the OFF time.

If either time is not set, the corresponding time display is blank "--:--".

### 2 Press the SET TEMP./DAY button to select the day that you want to set up.

▲ : Use to advance the day forward.

▼ : Use to turn the day back.

DAY CODE	1	2	3	4	5	6	7
DAY OF THE WEEK	MON	TUE	WED	THU	FRI	SAT	SUN

### 3 Hold the SET button down for 3 seconds.

The "WEEKLY 1" ON time starts flashing, and the fan speed and operating mode displays go off.

### 4 Press the SET TIME button to set the day's first ON time.

▲ : Use to advance the time forward.

▼ : Use to turn the time back.

(Press once to move the time 5 minute; hold down and the time will move 10 minutes at a time.)

### 5 Press the SET button.

This registers the first ON time setting for the selected day.

The ON time display stops flashing, and the "WEEKLY 1" OFF time starts flashing.

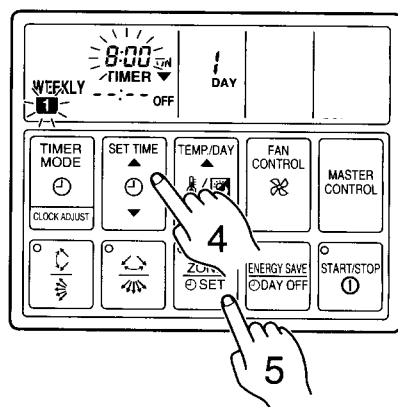
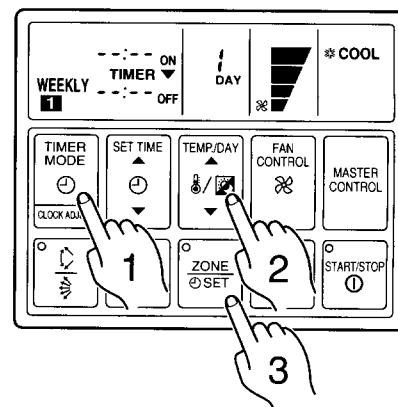

**6 Press the SET TIME button to set the day's first OFF time.**

The earliest OFF time you can set is 5 minutes after the ON time. The latest OFF time is 23:55 on the subsequent day.

**7 Press the SET button.**

This registers the first OFF time for the day, completing the "WEEKLY 1" settings for that day. The display switches to "WEEKLY 2", and the day's second ON time begins flashing.

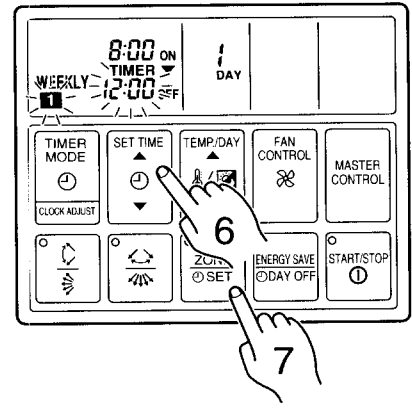

If the timer is not set, press the SET button with the time display blank "--:--", and perform next operation.

**8 Repeat the operations described in Steps 4 to 7 to set the second ON and OFF times for the day (the "WEEKLY 2" times).**

When you press the SET button after setting the "WEEKLY 2" OFF time, the system registers the "WEEKLY 2" settings for the day and returns you to the "WEEKLY 1" ON time setup process. (The first ON setting reappears and begins flashing.)

You can review your settings by pressing the SET button. Each press moves you to the next setting, as follows.

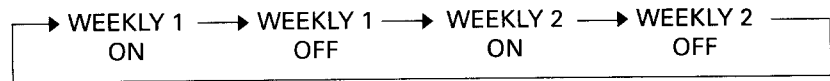

**9 Press the SET TEMP./DAY button to select another day for setup. The repeat steps 4 to 8 above to set the ON and OFF times for that day.**

**10 When you have finished setting all of the times, hold down the SET button for 3 seconds.**

The WEEKLY display flashes for 3 seconds while the new WEEKLY TIMER settings are registered, and then the clock display reappears.

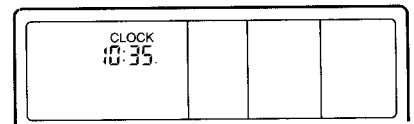

**NOTES:**

- (1) If no time values are flashing, the clock display will automatically reappear after 15 seconds if no buttons are pressed.
- (2) A flashing time value indicates that the system is in time-setting mode. To return to the clock display you must hold down the SET button for 3 seconds.
- (3) You do not need to set values for both WEEKLY 1 and WEEKLY 2. If you wish, you can set values only for WEEKLY 1 or only for WEEKLY 2.
- (4) The allowable range for the day's time settings is shown below.

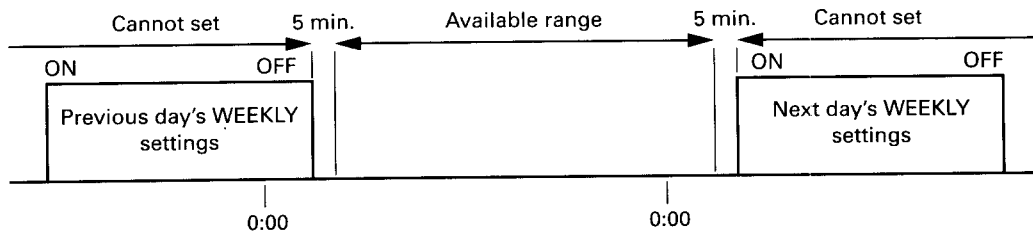

- (5) If you set the OFF time to occur on the day following the ON time, the NEXT DAY caption appears on the display.

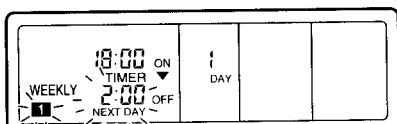

# TIMER OPERATION (WEEKLY TIMER)

## Starting Weekly Timer Operation

- 1 Press the **TIMER MODE** button so that "WEEKLY" appears on the display.
- 2 Press the **START/STOP** button to start operation.  
(This step is not necessary if the air conditioner is already running.)

Weekly timer operation starts, and the operation lamp comes on.  
(If the current time is between the first or second ON and OFF time settings for the current day, the air conditioner will start. Otherwise the air conditioner will remain off.)

The day display is replaced by the temperature display.  
The upper time display now shows the current time, and the lower time display shows the next scheduled ON or OFF time.

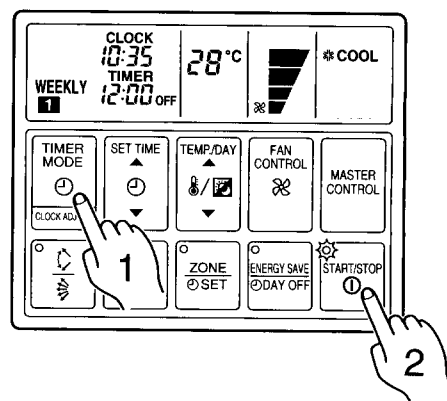

## To Stop Weekly Timer Operation

- To stop weekly timer while leaving the air conditioner running:  
Press the **TIMER MODE** button to select **NONSTOP**, **OFF TIMER**, or **ON TIMER**.
- To stop weekly timer operation and the air conditioner also:  
Press the **START/STOP** button.

## Reviewing the Time Settings

Press the **START/STOP** button to stop the air conditioner, and then proceed as follows.

- 1 Press the **TIMER MODE** button so that "WEEKLY" appears on the display.
- 2 Press the **SET TEMP./DAY** button to select the day that you want check.
- 3 Press the **SET TIME** button (**▲** or **▼**) to switch between the "WEEKLY 1" or "WEEKLY 2" time displays.

## Cancelling Selected Time Settings

Press the **START/STOP** button to stop the air conditioner, and then proceed as follows.

- 1 Carry out steps 1 to 3 of the "Setting Up the Weekly Timer Operation" procedure to select the day you want to edit.
- 2 Press the **SET** button to select the ON time that you want to cancel.  

Be sure to select an ON time (the upper time display).
- 3 Hold down the **▼** side of the **SET TIME** button until the time display becomes blank "----".
- 4 Press the **SET** button.  
The first OFF time setting ("WEEKLY 1" OFF time) is deleted and replaced by a flashing blank pattern "----".
- 5 Press the **SET** button again.  
This completes deletion of the "WEEKLY 1" ON/OFF settings.  
The second ON time setting ("WEEKLY 2" ON time) appears and flashes.  
If you wish to delete other time settings, repeat steps 2 through 5.
- 6 Once the setting has been canceled, hold down the **SET** button for 3 seconds.  
The WEEKLY display flashes briefly, and then the clock display appears.

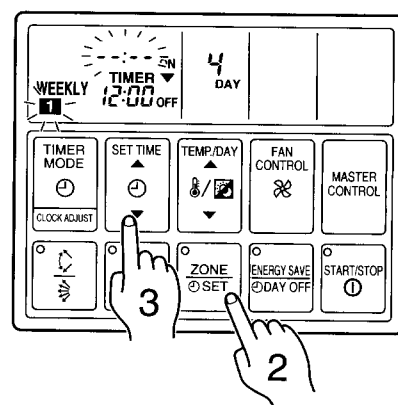

**Example:** Clearing the "WEEKLY 1" ON/OFF times for day 4 (Thursday)

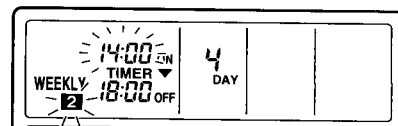
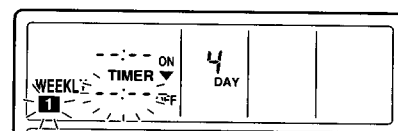

## To Change Selected Time Settings

Press the START/STOP button to stop the air conditioner, and then proceed as follows.

**1** Carry out steps 1 to 3 of the "Setting Up the Weekly Timer Operation" procedure to select the day you want to edit.

**2** Press the SET button to select the time that you want to change.

The selected setting flashes on the display. Each press moves you to the next setting for the selected day, as follows.

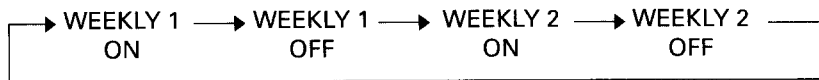

**3** Press the SET TIME button to change the time setting.

**4** Press the SET button.

The new setting overwrites the previous setting.

**5** Once the setting has been canceled, hold down the SET button for 3 seconds.

The WEEKLY display flashes briefly, and then the clock display appears.

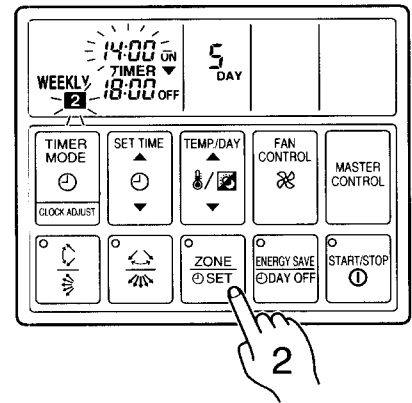

**Example:** Changing the "WEEKLY 2" ON setting for day 5 (Friday) from 14:00 to 15:30

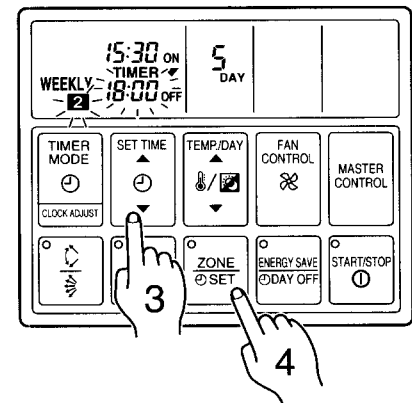

### NOTES:

In the following cases, cancel the set time prior to making the required amendments.

(1) If you want to change the ON time to a time that is later than the currently set OFF time.

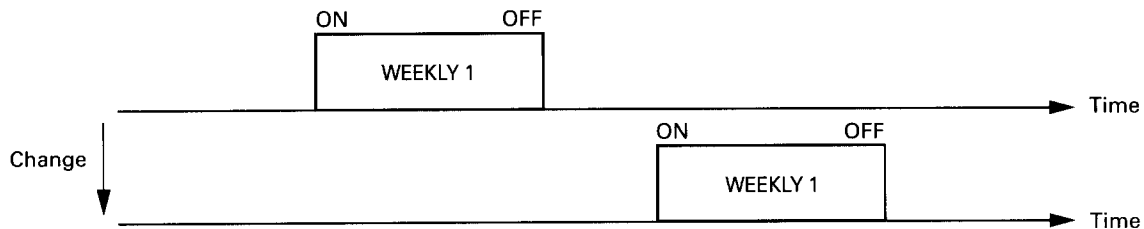

(2) If the change would cause a temporary overlap between the first and second ON/OFF time spans.

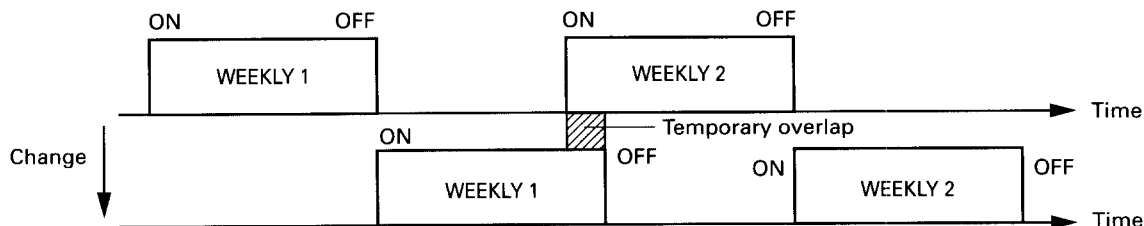

# TIMER OPERATION (WEEKLY TIMER)

## About the DAY OFF

- Use the DAY OFF setting to switch off timed operation for a selected day in the coming week.
- This is a temporary, one-time setting. The DAY OFF setting is automatically cleared as soon as the specified day passes.

## Using the DAY OFF Setting

Press the START/STOP button to stop the air conditioner, and then proceed as follows.

**1 Carry out steps 1 to 2 of the "Setting Up the Weekly Timer Operation" procedure to select the day that you want to set as the DAY OFF.**

**2 Press the DAY OFF button.**

The DAY OFF setting is registered, and the DAY OFF caption appears on the display.

- To cancel the DAY OFF setting:  
You can cancel the setting by pressing the DAY OFF button again.

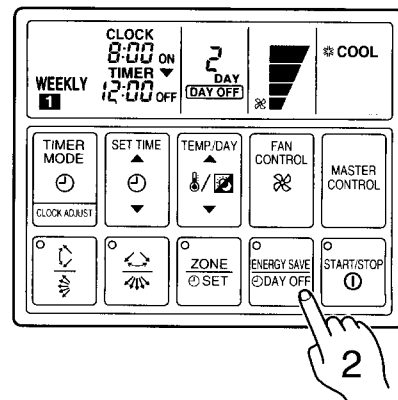

**Example:** To switch off timed operation for day 2 (Tuesday)

### NOTES:

- (1) The DAY OFF setting is only available for days for which weekly time settings already exist.
- (2) You can make this setting for any of the next seven days (counting from the current day).
- (3) The DAY OFF setting is effective over the range illustrated below. The Weekly setting for which an ON time has been set is eligible for the day in which the DAY OFF has been set.

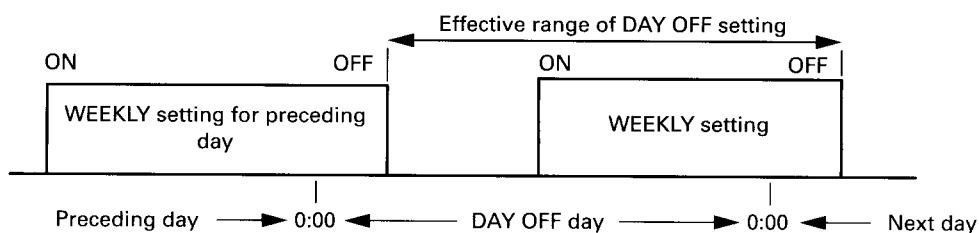

- (4) The display on the clock's lower line will usually be "--:--" for the DAY OFF set day during Weekly operations.

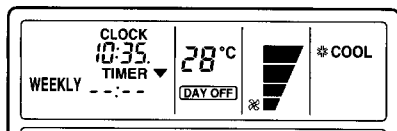

## Precautions during setup

Setup is not possible in the following cases, so amend the time.

- If you set an ON time while leaving the OFF time setting blank:  
Nothing will happen when you press the SET button.  
To proceed, press the SET TIME button and enter an appropriate setting.
- When an attempt is made to set only the OFF time.  
Nothing will happen when you press the SET TIME button.  
Press the SET button and amend the entry for the ON time.
- ON and OFF times cannot be set to the same value.
- The OFF time cannot be set earlier than the ON time.
- The WEEKLY 2 settings cannot be set earlier than the WEEKLY 1 settings.
- The WEEKLY 1 and WEEKLY 2 time spans cannot overlap.

# ENERGY SAVE OPERATION

Instructions relating to heating (\*) are applicable only to "HEAT & COOL MODEL" (Reverse Cycle).

## To Use the ENERGY SAVE

### Press the ENERGY SAVE button.

The unit will run in the ENERGY SAVE mode.

## To Stop the ENERGY SAVE

### Press the ENERGY SAVE button one more time.

The ENERGY SAVE mode will be turned off.

The ENERGY SAVE light goes off, and the unit will return to the former operating conditions.

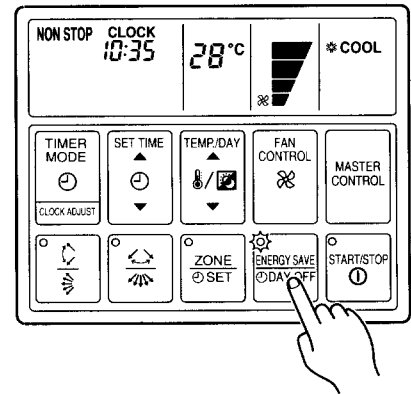

## About the ENERGY SAVE

- The energy conservation mode (ENERGY SAVE) raises the set temperature slightly in the cooling mode and lowers the set temperature in the heating mode, using a computer program to economically control the operation of the unit.
- If you press the ENERGY SAVE button while the air conditioner is on, it will change to the conservation mode. If you press the ENERGY SAVE button while the unit is in the timer mode (ON timer1, ON timer2 or WEEKLY timer), the unit will go into the conservation mode when the unit starts with the timer.
- If you turn off the air conditioner while in the conservation mode, the mode will be shut off.
- The temperature set on the remote controller will not change if the energy save mode is used.

### ■ \*When Heating

After the ENERGY SAVE button is pressed, the set temperature will be lowered about 1 °C every 30 minutes. When it has lowered a total of 2 °C, then it will hold that temperature.

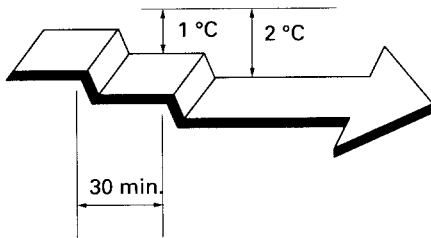

▲ Set to the ENERGY SAVE mode.

### ■ When Cooling

After the ENERGY SAVE button is pressed, the set temperature will be raised about 0.5 °C every 30 minutes. When it has gone up a total of 1 °C, then it will hold that temperature.

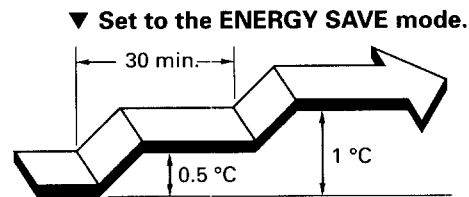

▼ Set to the ENERGY SAVE mode.



# ADJUSTING THE DIRECTION OF AIR CIRCULATION

Instructions relating to heating (\*) are applicable only to "HEAT & COOL MODEL" (Reverse Cycle).  
Begin air conditioner operation before performing this procedure.

## Vertical Air Direction Adjustment

This instructions are applicable to "CEILING SUSPENSION TYPE", "FLOOR CONSOLE/UNDER CEILING DUAL TYPE", "CASSETTE TYPE" and "WALL MOUNTED TYPE".

Press the **VERTICAL AIR FLOW DIRECTION SET** button .

Each time the button is pressed, the air direction range will change as follows:

① ↔ ② ↔ ③ ↔ ④

The remote controller's display does not change.

Fig. 21

### ■ CEILING SUSPENSION TYPE

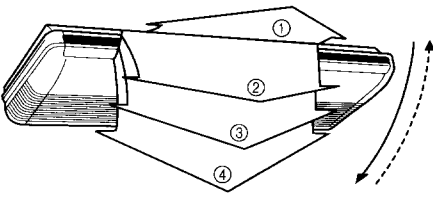

### ■ FLOOR CONSOLE/UNDER CEILING DUAL TYPE

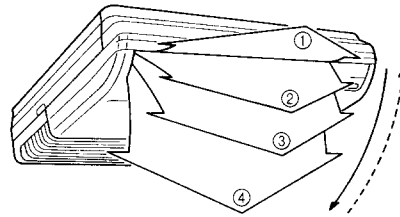

### ■ CASSETTE TYPE

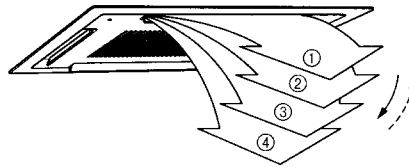
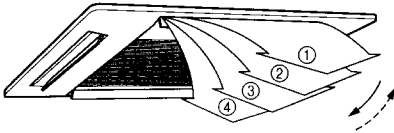

### ■ WALL MOUNTED TYPE

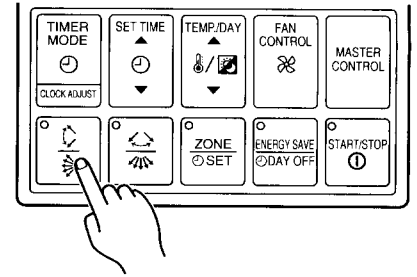
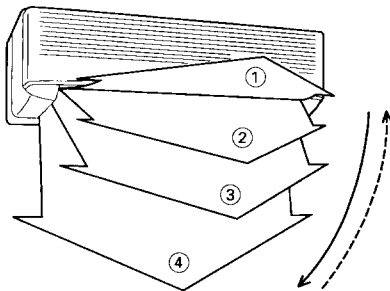

Example: When set to vertical air direction

### ⚠ DANGER!

Never place fingers or foreign objects inside the outlet port could cause personal injury.

- Always use the remote controller's AIR FLOW DIRECTION button to adjust the UP/DOWN air direction flap or RIGHT/LEFT air direction louvers. Attempting to move them manually could result in improper operation; in this case, stop operation and restart. The flaps should begin to operate properly again.
- During use of the Cooling mode, do not set the UP/DOWN air direction flap in the ④ position for long periods of time, since water vapor may condense near the outlet port and drops of water may drip from the air conditioner.
- When used in a room with infants, children, elderly or sick persons, the air direction and room temperature should be considered carefully when making settings.

- Use the air direction adjustments within the ranges shown above.
- The vertical airflow direction is set automatically as shown, in accordance with the type of operation selected.
  - During Cooling mode : Horizontal flow ①
  - \* During Heating mode : Downward flow ④
- During AUTO mode operation, for the first minute after beginning operation, airflow will be horizontal ①; the air direction cannot be adjusted during this period.

# ADJUSTING THE DIRECTION OF AIR CIRCULATION

## Horizontal Air Direction Adjustment

This instructions are applicable to "CEILING SUSPENSION TYPE", "FLOOR CONSOLE/UNDER CEILING DUAL TYPE" and "WALL MOUNTED TYPE".

**Press the HORIZONTAL AIR FLOW DIRECTION SET button.**

Each time the button is pressed, the air direction range will change as follows:

① ↔ ② ↔ ③ ↔ ④ ↔ ⑤

The remote controller's display does not change.

Fig. 22

### ■ CEILING SUSPENSION TYPE

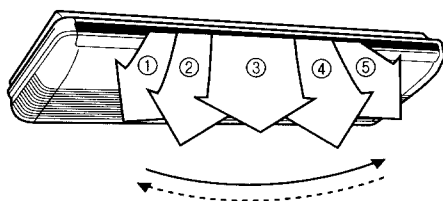

### ■ FLOOR CONSOLE/ UNDER CEILING DUAL TYPE

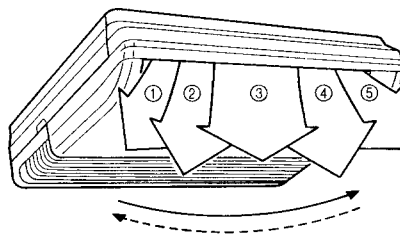

### ■ WALL MOUNTED TYPE

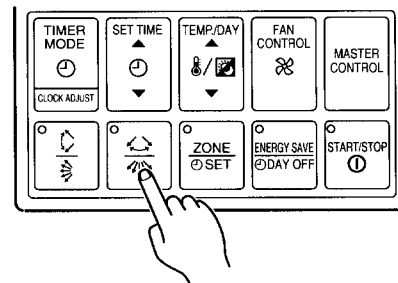
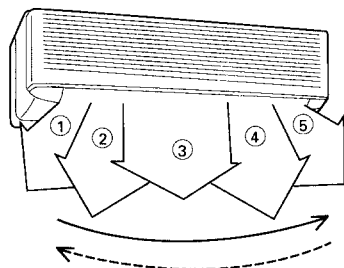

**Example:** When set to horizontal air direction

## SWING OPERATION

Instructions relating to "the indoor unit's indicator lamp" (\*\*) are applicable to "CEILING SUSPENSION TYPE", "FLOOR CONSOLE/UNDER CEILING DUAL TYPE", "CASSETTE TYPE" and "WALL MOUNTED TYPE".

Begin air conditioner operation before performing this procedure.

### To select Vertical airflow SWING Operation

This instructions are applicable to "CEILING SUSPENSION TYPE", "FLOOR CONSOLE/ UNDER CEILING DUAL TYPE", "CASSETTE TYPE" and "WALL MOUNTED TYPE".

**Press the VERTICAL SWING button for more than two seconds.**

The remote controller's VERTICAL SWING lamp (orange) \*\*and indoor unit's SWING indicator lamp (VERTICAL SWING) (orange) will light up.

In this mode, the UP/DOWN air direction flaps will swing automatically to direct the air flow both up and down.

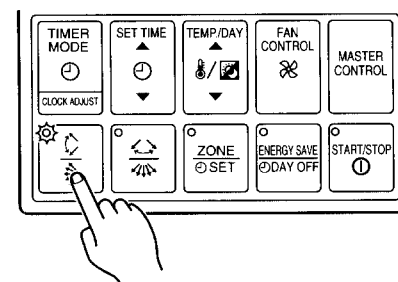

**Example:** When set to vertical swing

### To Stop Vertical airflow SWING Operation

**Press the VERTICAL SWING button for more than two seconds once again.**

The remote controller's VERTICAL SWING lamp \*\*and indoor unit's SWING indicator lamp (VERTICAL SWING) will go out.

Airflow direction will return to the setting before swing was begun.

# SWING OPERATION

Instructions relating to “the indoor unit’s indicator lamp” (\*\*) are applicable to “CEILING SUSPENSION TYPE”, “FLOOR CONSOLE/UNDER CEILING DUAL TYPE”, “CASSETTE TYPE” and “WALL MOUNTED TYPE”.

## About Vertical Airflow Swing Operation

- The range of swing is relative to the currently set airflow direction.

Air flow direction set	Range of swing
①	① to ③
②	② to ④
③	② to ④
④	① to ④ (All range)

Air direction range (See page 17, Fig. 21)

- If the swing range is not as desired, use the remote controller’s VERTICAL AIR FLOW DIRECTION SET button to change the range of swing.
- The SWING operation may stop temporarily when the air conditioner’s fan is not operating, or when operating at very low speeds.
- During use of the Cooling mode, do not set the air UP/DOWN direction flap, in the ④ position for long periods of time, since water vapor may condense near the outlet port and drops of water may drip from the air conditioner.

## To select Horizontal Airflow SWING Operation

This instructions are applicable to “CEILING SUSPENSION TYPE”, “FLOOR CONSOLE/UNDER CEILING DUAL TYPE” and “WALL MOUNTED TYPE”.

**Press the HORIZONTAL SWING button for more than two seconds.**

The remote controller’s HORIZONTAL SWING lamp (orange) \*\*and indoor unit’s SWING indicator lamp (HORIZONTAL SWING) (orange) will light up. In this mode, the RIGHT/LEFT air direction louvers will swing automatically to direct the airflow both right and left.

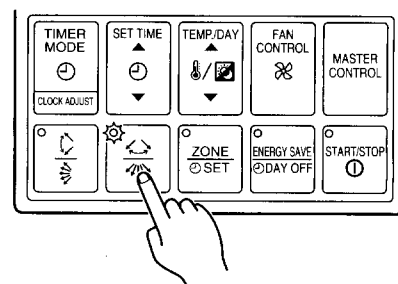

**Example:** When set to horizontal swing

## To Stop Horizontal airflow SWING Operation

**Press the HORIZONTAL SWING button for more than two seconds once again.**

The remote controller’s HORIZONTAL SWING lamp \*\*and indoor unit’s SWING indicator lamp (HORIZONTAL SWING) will go out. Airflow direction will return to the setting before swing was begun.

## About Horizontal Airflow Swing Operation

- The range of swing is relative to the currently set airflow direction.

Air flow direction set	Range of swing
①	① to ⑤ (All range)
②	① to ③
③	② to ④
④	③ to ⑤
⑤	① to ⑤ (All range)

Air direction range (See page 18, Fig. 22)

- If the swing range is not as desired, use the remote controller’s HORIZONTAL AIR FLOW DIRECTION SET button to change the range of swing.
- The SWING operation may stop temporarily when the air conditioner’s fan is not operating, or when operating at very low speeds.

# SYSTEM OPERATION

There are different ways the unit can be controlled. (Consult the remote controller operating instructions for details on setting the operating functions.)

## <Spare Remote Controller>

Two remote controllers can be connected to one air conditioner unit. The air conditioner operation contents are the remote controller setting contents set later.

(Both remote controllers show the same display.)

The timer function will not be able to be used on the slave units.

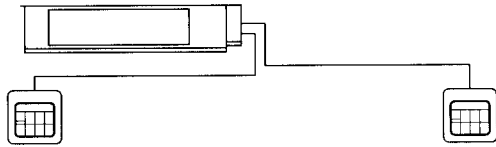

## <Control Several Units with just one Remote Controller>

One remote controller can control up to 16 air conditioners.

All the air conditioners can be operated with the same setting.

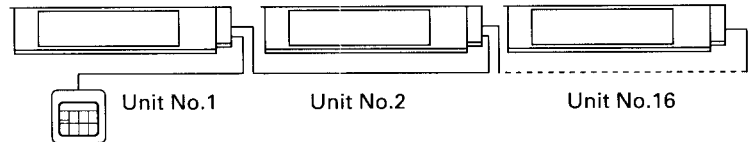

### To Use the ZONE CONTROL

When the ZONE CONTROL button is pressed while multiple air conditioners are being centralized controlled, only the preset air conditioners stop.

#### Press the ZONE CONTROL button.

Preset units will stop.

### To Stop the ZONE CONTROL

#### Press the ZONE CONTROL button one more time.

Those units that were stopped will start again.

### To Use the ANTI FREEZE

Press the VERTICAL AIR FLOW DIRECTION and the HORIZONTAL AIR FLOW DIRECTION SET Button at the same time for more than three seconds.

This operation is only enabled with the remote controller set to stop mode.

### To Stop the ANTI FREEZE

Press the VERTICAL AIR FLOW DIRECTION and the HORIZONTAL AIR FLOW DIRECTION SET Button at the same time for more than three seconds once again.

This operation is only enabled with the remote controller set to stop mode.

### About the ANTI FREEZE

The freeze prevention function operates when the START/STOP button is pressed and the remote controller is in stop mode (indoor unit is in stop mode). Whenever the room temperature becomes low, it automatically sets the fan to low speed and starts the heating operation. This operation stops when the temperature in the room rises above a preset level.

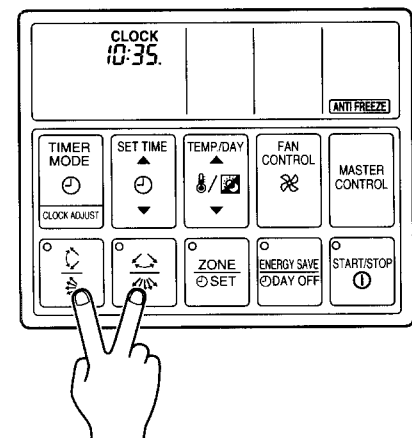
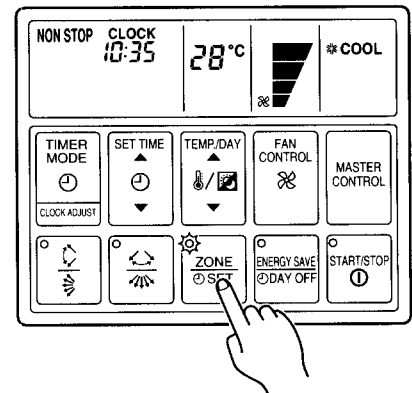

# ERRORS AND SELF DIAGNOSIS

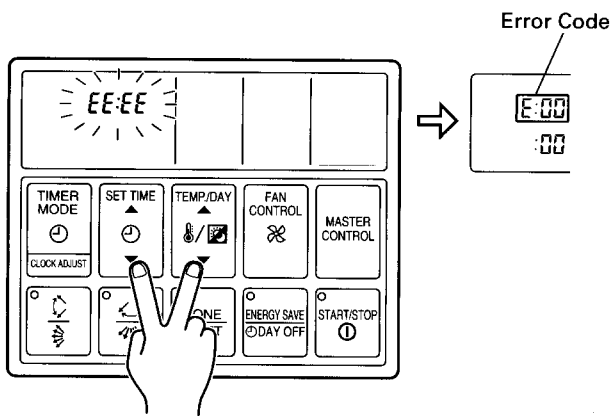

If there is a problem with the air conditioner, it will stop running and "EE: EE" will be displayed instead of the clock.

- (1) If the operation lamp is on then press the **START/STOP** button to turn it off.
- (2) Press the **SET TIME (▼)** and the **SET TEMP./DAY (▲)** buttons at the same time for more than three seconds to start the self diagnosis check.  
An error code will be displayed in the clock display area.
- (3) Press the **SET TIME (▼)** and the **SET TEMP./DAY (▲)** buttons again for more than three seconds to end the self diagnosis check.

Error Code	Error contents
E:00	No error
E:02	Model information abnormal
E:04	Power supply frequency abnormal
E:06	EEPROM access error
E:07	EEPROM deletion error
E:09	Room temperature thermistor error
E:0A	Indoor unit heat exchanger thermistor (inlet) error
E:0B	Indoor unit heat exchanger thermistor (middle) error
E:0C	Indoor unit heat exchanger thermistor (outlet) error
E:0D	Blower temperature thermistor error
E:11	Drain abnormal
E:12	Room temperature abnormal
E:13	Indoor unit fan error
E:1F	Transmission error
E:20	Node setting error
E:21	Parallel communication error
E:22	Outdoor unit error

# CLEANING AND CARE

- When used for extended periods, the unit may accumulate dirt inside, reducing its performance. We recommend that the unit be inspected regularly, in addition to your own cleaning and care. For more information, consult authorized service personnel.
- When cleaning the unit's body, do not use water hotter than 40 °C, harsh abrasive cleansers, or volatile agents like benzene or thinner.
- Do not expose the unit body to liquid insecticides or hairsprays.
- If the unit will not be operated for a period of one month or more, be sure to allow the inner parts of the unit to dry thoroughly, in advance, by operating the unit in fan mode for half a day.

## ■ CEILING SUSPENSION TYPE

-  **CAUTION!**
- Before cleaning the air conditioner, be sure to turn it off and disconnect the power supply.
  - Turn off the electrical breaker.

### Cleaning the Air Filter

#### 1. Pull the air filters upward to remove them.

Remove the air filters by raising its handle while pulling it out towards you.

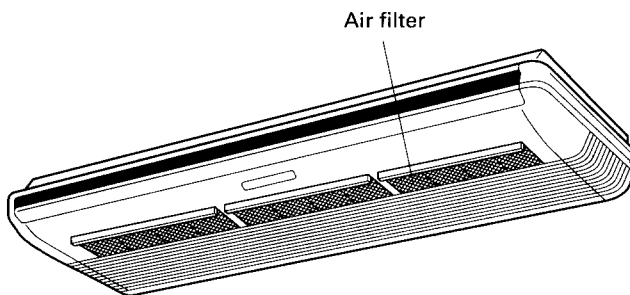

#### 2. Clean the air filters.

Remove the dust from the air filters by vacuuming or washing them. After washing, allow the air filters to dry thoroughly in an area protected from sunlight.

#### 3. Re-attach the air filters to the intake grille.

The air filters fit onto the inside of the intake grille.

- Dust can be cleaned from the air filter either with a vacuum cleaner, or by washing the filter in a solution of mild detergent and warm water. If you wash the filter, be sure to allow it to dry thoroughly in a shady place before re-installing.
- If dirt is allowed to accumulate on the air filter, air flow will be reduced, lowering operating efficiency and increasing noise.
- During periods of normal use, the air filters should be cleaned every four weeks.

# CLEANING AND CARE

## ■ FLOOR CONSOLE/UNDER CEILING DUAL TYPE



### CAUTION!

- Before cleaning the air conditioner, be sure to turn it off and disconnect the power supply cord.
- Be sure the intake grille is installed securely.
- When removing and replacing the air filters, be sure not to touch the heat exchanger, as personal injury may result.

### Cleaning the Air Filter

#### 1. Pull out both sides and the center of the intake grille.

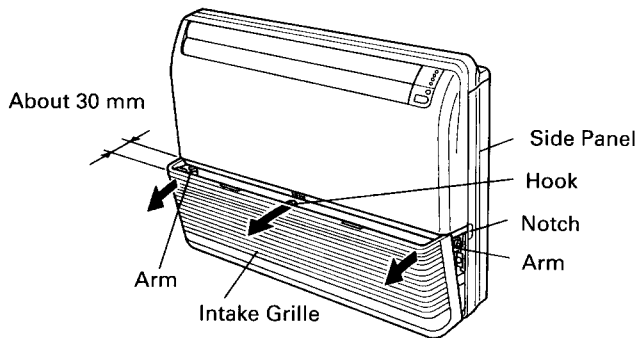

#### 2. Pull the air filters upward to remove them.

Push the air filter handles away from the intake grille in direction ①, then pull out the air filters.

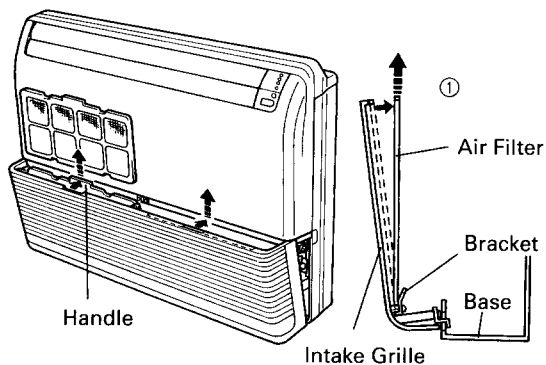

#### 3. Clean the air filters.

Remove the dust from the air filters by vacuuming or washing them. After washing, allow the air filters to dry thoroughly in an area protected from sunlight.

#### 4. Re-attach the air filters to the intake grille.

- ① The air filters fit onto the inside of the intake grille. (figure 1)
- ② The bottom edges of the air filters should fit into the filter brackets. (figure 1)
- ③ The air filters should be pushed down so that their top edges fit under the projections at the top of the intake grille. (figure 2)

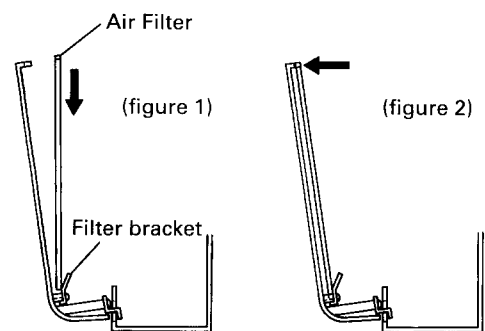

#### 5. Push in both sides and the center of the intake grille.

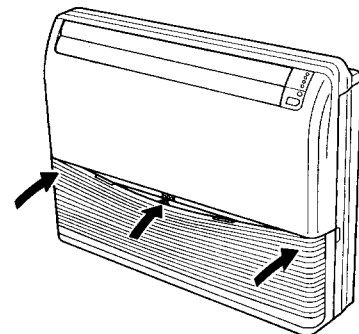

- Dust can be cleaned from the air filter either with a vacuum cleaner, or by washing the filter in a solution of mild detergent and warm water. If you wash the filter, be sure to allow it to dry thoroughly in a shady place before re-installing.
- If dirt is allowed to accumulate on the air filter, air flow will be reduced, lowering operating efficiency and increasing noise.
- During periods of normal use, the air filters should be cleaned every two weeks.

## ■ CASSETTE TYPE (COMPACT)

### CAUTION!

- Before cleaning the unit, be sure to stop the unit and disconnect the power supply.
- Turn off the electrical breaker.
- A fan operates at high speed inside the unit, and personal injury could result.

### Cleaning the Air Filter

1. Push the intake grille's hooks inward towards the center of the unit to open the intake grille.

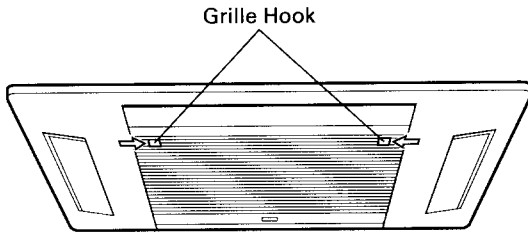

2. Pull out the filter from the intake grille.

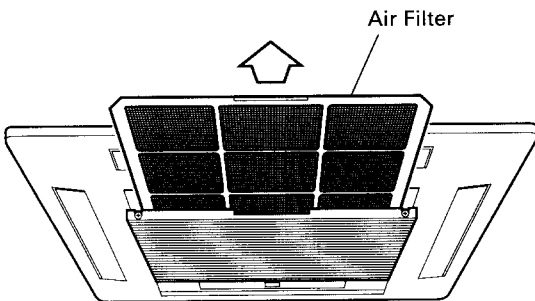

3. Clean the air filters.

Remove the dust from the air filters by vacuuming or washing them. After washing, allow the air filters to dry thoroughly in an area protected from sunlight.

4. Re-attach the air filters to the intake grille.

- ① Replace the air filter into its holder.
- ② Make sure that the air filter makes contact with the filter stopper when it is replaced into its holder.

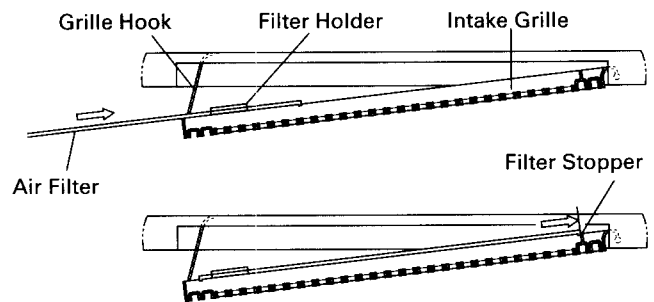

5. Close the intake grille and push the intake grille's hooks outward.

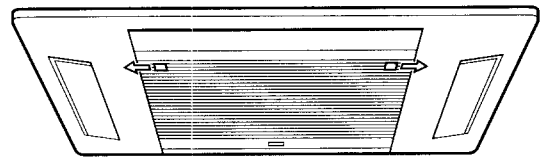

- Dust can be cleaned from the air filter either with a vacuum cleaner, or by washing the filter in a solution of mild detergent and warm water. If you wash the filter, be sure to allow it to dry thoroughly in a shady place before re-installing.
- If dirt is allowed to accumulate on the air filter, air flow will be reduced, lowering operating efficiency and increasing noise.
- During periods of normal use, the air filters should be cleaned every two weeks.



# CLEANING AND CARE

## ■ CASSETTE TYPE

### CAUTION!

- Before cleaning the unit, be sure to stop the unit and disconnect the power supply.
- Turn off the electrical breaker.
- A fan operates at high speed inside the unit, and personal injury could result.

### Cleaning the Air Filter

1. Push the intake grille pushbuttons (two places).
2. Open the intake grille.

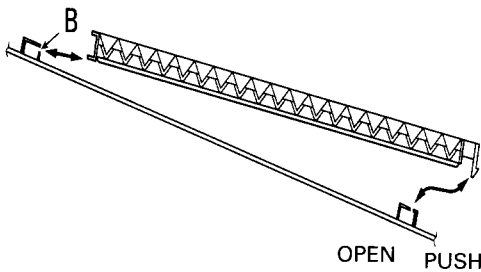

3. Hold down the hook at A and pull the filter out.

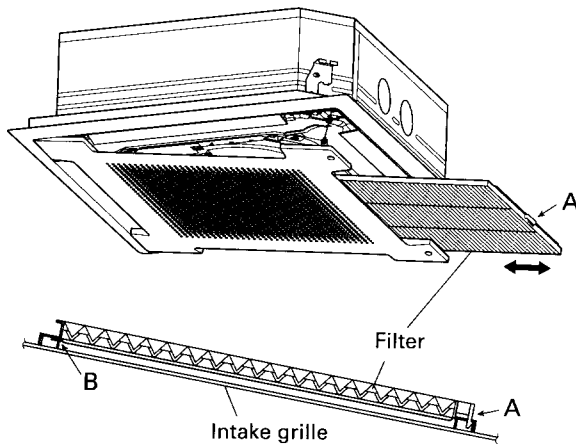

- When reinstalling the filter, be sure that the hooks at A and B engage correctly into place.

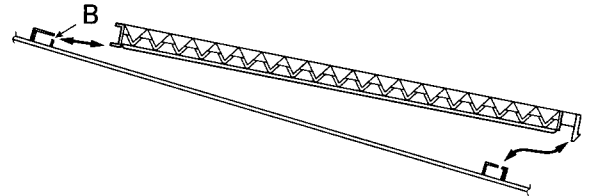

### 4. Clean the air filters.

Remove the dust from the air filters by vacuuming or washing them. After washing, allow the air filters to dry thoroughly in an area protected from sunlight.

- Dust can be cleaned from the air filter either with a vacuum cleaner, or by washing the filter in a solution of mild detergent and warm water. If you wash the filter, be sure to allow it to dry thoroughly in a shady place before reinstalling.
- If dirt is allowed to accumulate on the air filter, air flow will be reduced, lowering operating efficiency and increasing noise.
- During periods of normal use, the air filters should be cleaned every two months.

## ■ DUCT TYPE

### CAUTION!

- Before cleaning the unit, be sure to stop the unit and disconnect the power supply.
- Turn off the electrical breaker.
- A fan operates at high speed inside the unit, and personal injury could result.

### Installing the Air Filter

Be sure the filter is always installed in the inlet air grille of the indoor unit.

-  Filters can be purchased through your local dealer.

### Cleaning the Air Filter

If dirt is allowed to collect in the air filter, the airflow will be reduced, leading to reduced performance, and increased operation noise. Be sure to clean the filters regularly.

### How to Cleaning

Use a vacuum cleaner to remove dust and dirt from the air filter, or wash in a synthetic detergent. After washing, dry in a shaded place, then reinstall.

## CAUTION!

- Before cleaning the air conditioner, be sure to turn it off and disconnect the power supply cord.
- Be sure the intake grille is installed securely.
- When removing and replacing the air filters, be sure not to touch the heat exchanger, as personal injury may result.

### Cleaning the Intake Grille

#### 1. Remove the intake grille.

- ① Place your fingers at both lower ends of the grille panel, and lift forward; if the intake grille seems to catch partway through its movement, continue lifting upward to remove.

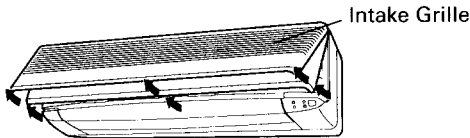

- ② Lift up the intake grille fully to remove.

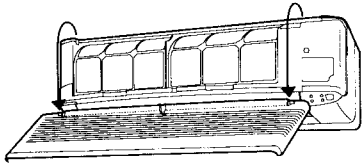

#### 2. Clean with water.

Remove dust with a vacuum cleaner; wipe the unit with warm water, then dry with a clean, soft cloth.

#### 3. Replace the intake grille.

- ① Holding the intake grille horizontally, fasten the two upper hooks on the unit.

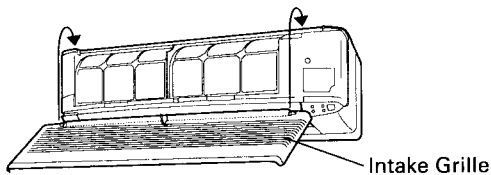

- ② Press the intake grille down at the lower sides to close.

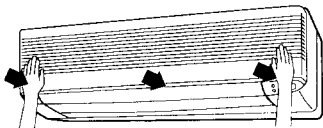

### Cleaning the Air Filter

#### 1. Open the intake grille, and remove the air filter.

Lift up the air filter's handle, disconnect the two lower tabs, and pull out.

Air filter handle

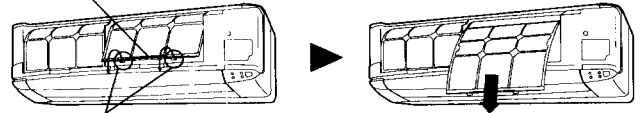

Hooks (two places)

#### 2. Remove dust with a vacuum cleaner or by washing.

After washing, allow to dry thoroughly in a shaded place.

#### 3. Replace the air filter and close the intake grille.

- ① Align the sides of the air filter with the panel, and push in fully, making sure the two lower tabs are returned properly to their holes in the panel.

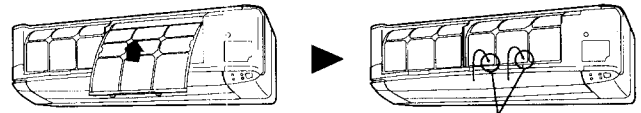

- ② Close the intake grille.

Hooks (two places)

(For purposes of example, the illustration shows the unit without intake grille installed.)

- Dust can be cleaned from the air filter either with a vacuum cleaner, or by washing the filter in a solution of mild detergent and warm water. If you wash the filter, be sure to allow it to dry thoroughly in a shady place before reinstalling.
- If dirt is allowed to accumulate on the air filter, air flow will be reduced, lowering operating efficiency and increasing noise.
- During periods of normal use, the air filters should be cleaned every two weeks.

### When using the optional Air Cleaning Filter

- Install the optional air cleaning filter set as instructed (installation instructions are furnished with the air cleaning filter set).

- When used for extended periods, the unit may accumulate dirt inside, reducing its performance. We recommend that the unit be inspected regularly, in addition to your own cleaning and care. For more information, consult authorized service personnel.
- When cleaning the unit's body, do not use water hotter than 40 °C, harsh abrasive cleansers, or volatile agents like benzene or thinner.
- Do not expose the unit body to liquid insecticides or hairsprays.
- When shutting down the unit for one month or more, first allow the fan mode to operate continuously for about one-half day to allow internal parts to dry thoroughly.

# TROUBLESHOOTING

Instructions relating to heating(\*) are applicable only to "HEAT & COOL MODEL" (Reverse Cycle).

Instructions relating to "the OPERATION indicator lamp" (\*\*) are applicable to "CEILING SUSPENSION TYPE", "FLOOR CONSOLE/UNDER CEILING DUAL TYPE", "CASSETTE TYPE" and "WALL MOUNTED TYPE".



In the event of a malfunction (burning smell, etc.), immediately stop operation, turn off the electrical breaker, and consult authorized service personnel.

Merely turning off the unit's power switch will not completely disconnect the unit from the power source. Always be sure to turn off the electrical breaker to ensure that power is completely off.

Before requesting service, perform the following checks:

	Symptom	Problem	See Page
NORMAL FUNCTION	Doesn't operate immediately:	<ul style="list-style-type: none"> <li>● If the unit is stopped and then immediately started again, the compressor will not operate for about 3 minutes, in order to prevent fuse blowouts.</li> <li>● Whenever the electrical breaker is turned off then on again, the protection circuit will operate for about 3 minutes, preventing unit operation during that period.</li> </ul>	—
	Noise is heard:	<ul style="list-style-type: none"> <li>● During operation and immediately after stopping the unit, the sound of water flowing in the air conditioner's piping may be heard. Also, noise may be particularly noticeable for about 2 to 3 minutes after starting operation (sound of coolant flowing).</li> <li>● During operation, a slight squeaking sound may be heard. This is the result of minute expansion and contraction of the panel due to temperature changes.</li> </ul>	—
		*● During Heating operation, a sizzling sound may be heard occasional. This sound is produced by the Automatic Defrosting operation.	28
	Smells:	<ul style="list-style-type: none"> <li>● Some smell may be emitted from the indoor unit. This smell is the result of room smells (furniture, tobacco, etc.) which have been taken into the air conditioner.</li> </ul>	—
	Mist or steam are emitted:	<ul style="list-style-type: none"> <li>● During Cooling operation, a thin mist may be seen emitted from the indoor unit. This results from the sudden Cooling of room air by the air emitted from the air conditioner, resulting in condensation and misting.</li> </ul>	—
		*● During Heating operation, the outdoor unit's fan may stop, and steam may be seen rising from the unit. This is due to Automatic Defrosting operation.	28
	Airflow is weak or stops:	<ul style="list-style-type: none"> <li>*● When Heating operation is started, fan speed is temporarily very low, to allow internal parts to warm up.</li> <li>*● During Heating operation, if the room temperature rises above the thermostat setting, the outdoor unit will stop, and the indoor unit will operate at very low fan speed. If you wish to warm the room further, set the thermostat for a higher setting.</li> </ul>	—
		*● During Heating operation, the unit will temporarily stop operation (between 2 and 16 minutes) as the Automatic Defrosting mode operates. During Automatic Defrosting operation, [DEFROST] will be shown on the remote controller display **and the OPERATION indicator lamp will flash.	28
		● The fan may operate at very low speed when the unit is monitoring the room's temperature.	9
		● In the monitor AUTO operation, the fan will operate at very low speed.	9
Water is produced from the outdoor unit:	*● During Heating operation, water may be produced from the outdoor unit due to Automatic Defrosting operation.	28	

# TROUBLESHOOTING

Instructions relating to heating (\*) are applicable only to "HEAT & COOL MODEL" (Reverse Cycle).

Instructions relating to "the TIMER indicator lamp" (\*\*) are applicable to "CEILING SUSPENSION TYPE", "FLOOR CONSOLE/ UNDER CEILING DUAL TYPE", "CASSETTE TYPE" and "WALL MOUNTED TYPE".

	Symptom	Items to check	See Page
CHECK ONCE MORE	Doesn't operate at all:	<ul style="list-style-type: none"> <li>● Has there been a power failure?</li> <li>● Has a fuse blown out, or a circuit breaker been tripped?</li> <li>● Is the main power switch set to the OFF position.</li> </ul>	—
		<ul style="list-style-type: none"> <li>● Is the timer operating?</li> </ul>	10 to 15
	Poor Cooling (or *Heating) performance:	<ul style="list-style-type: none"> <li>● Is the air filter dirty?</li> <li>● Are the air conditioner's intake grille or outlet port blocked?</li> <li>● Did you adjust the room temperature settings (thermostat) correctly?</li> <li>● Is there a window or door open?</li> <li>● In the case of Cooling operation, is a window allowing bright sunlight to enter? (Close the curtains.)</li> <li>● In the case of Cooling operation, are there heating apparatus and computers inside the room, or are there too many people in the room?</li> </ul>	—

If the problem persists after performing these checks, or if you notice burning smells, \*\* or the TIMER indicator lamp flashes, stop operation immediately, turn off the electrical breaker, and consult with authorized service personnel.

## OPERATING TIPS

Instructions relating to heating (\*) are applicable only to "HEAT & COOL MODEL" (Reverse Cycle).

Instructions relating to "the OPERATION indicator lamp" (\*\*) are applicable to "CEILING SUSPENSION TYPE", "FLOOR CONSOLE/UNDER CEILING DUAL TYPE", "CASSETTE TYPE" and "WALL MOUNTED TYPE".

### Operation and Performance

#### \*Heating Performance

- This air conditioner operates on the heat-pump principle, absorbing heat from outdoor air and transferring that heat indoors. As a result, the operating performance is reduced as outdoor air temperature drops. If you feel that insufficient heating performance is being produced, we recommend you use this air conditioner in conjunction with another kind of heating appliance.
- Heat-pump air conditioners heat your entire room by recirculating air throughout the room, with the result that some time may be required after first starting the air conditioner until the room is heated.

#### \*Microcomputer-controlled Automatic Defrosting

When using the Heating mode under conditions of low outdoor temperature and high humidity, frost may form on the outdoor unit, resulting in reduced operating performance. In order to prevent this kind of reduced performance, this unit is equipped with a Microcomputer-controlled Automatic Defrosting function. If frost forms, the air conditioner will temporarily stop, and the defrosting circuit will operate briefly (for about 4 to 15 minutes). During Automatic Defrosting operation, **DEFROST** will be displayed on the remote controller, \*\* and the OPERATION indicator lamp (red) will flash.

#### Low Ambient Cooling

When the outdoor temperature drops, the outdoor unit's fans may switch to Low Speed, or one of the fans may stop intermittently.

# OPERATING TIPS

Instructions relating to heating (\*) are applicable only to "HEAT & COOL MODEL" (Reverse Cycle).

Instructions relating to "the OPERATION indicator lamp" (\*\*) are applicable to "CEILING SUSPENSION TYPE", "FLOOR CONSOLE/UNDER CEILING DUAL TYPE", "CASSETTE TYPE" and "WALL MOUNTED TYPE".

## Operation and Performance

### Cooling/Heating Priority (HEAT PUMP MODEL only)

- If another indoor unit in the same system is already operating in the cooling mode or dry mode, heating mode settings cannot be performed.
- If another indoor unit in the same system is already operating in the heating mode, cooling mode or dry mode settings cannot be performed.

### Oil Recovery Operation

Periodically, the oil recovery operation is performed in order to return compressor oil to the outdoor unit. Operation is stopped during this oil recovery operation. During oil recovery operation, **DEFROST** will be displayed on the remote controller, \*\* and the OPERATION indicator lamp (red) will flash.

### Setting Restriction

When "CENTRAL" is displayed there are functions for which settings cannot be made.

## AUTO Restart

### In Event of Power Interruption

- Should the power supply to the air conditioner be interrupted by a power failure, the air conditioner will restart automatically in the previously selected mode once the power is restored.
- There are functions that are enabled/disabled by DIP switch settings on the indoor unit.
- Use of other electrical appliances (electric shaver, etc.) or nearby use of a wireless radio transmitter may cause the air conditioner to malfunction. In this event, temporarily turn off the circuit breaker, reconnect it, and then use the remote controller to resume operation.

## Temperature and Humidity Range

Permissible range of temperature and humidity are as follows:

		Cooling/Dry Mode	*Heating Mode
Outdoor temperature	COOLING MODEL	About -5 to 52 °C	—
	HEAT & COOL MODEL HEAT RECOVERY MODEL (Reverse Cycle)	About -5 to 52 °C	About -15 to 21 °C
Indoor temperature		About 18 to 30 °C	About 16 to 30 °C
Indoor humidity		About 80 % or less If the unit is used for long periods under high-humidity conditions, condensation may form on the surface of the indoor unit, and drip onto the floor or other objects underneath.	—

- If the air conditioner is operated under higher temperature conditions than those listed, the built-in protection circuit may operate to prevent internal circuit damage. Also, during Cooling mode, if the unit is used under conditions of lower temperatures than those listed above, the heat-exchanger may freeze, leading to water leakage and other damage.
- Do not use this unit for any purposes other than the Cooling, (\*)Heating, Dehumidifying, and air-circulation of rooms in ordinary dwellings.

# SPECIFICATIONS

Models intended only for cooling have no heating capacity.

## CEILING SUSPENSION TYPE

MODEL		ABG30TF□MF	ABG36TF□MF	ABG45TF□MF	ABG54TF□MF
POWER		220-240 V~50 Hz			
COOLING CAPACITY	[kW]	8.6-8.8	10.3-10.5	12.4-12.7	13.9-14.1
HEATING CAPACITY	[kW]	8.8-9.1	10.5-10.7	13.4-13.7	15.4-15.8
<b>DIMENSIONS &amp; WEIGHT</b>					
HEIGHT	[mm]	240			
WIDTH	[mm]	1,660			
DEPTH	[mm]	700			
WEIGHT	[kg]	48			

## FLOOR CONSOLE/UNDER CEILING DUAL TYPE

MODEL		ABG12TF□MF	ABG14TF□MF	ABG18TF□MF	ABG24TF□MF
POWER		220-240 V~50 Hz			
COOLING CAPACITY	[kW]	3.40-3.50	3.95-4.05	5.2-5.3	6.5-6.6
HEATING CAPACITY	[kW]	4.00-4.10	4.9-5.0	5.5-5.6	7.6-7.7
<b>DIMENSIONS &amp; WEIGHT</b>					
HEIGHT	[mm]	199			
WIDTH	[mm]	990			
DEPTH	[mm]	655			
WEIGHT	[kg]	28			30

## DUCT TYPE (Compact)

MODEL		ARG7TF□MF	ARG9TF□MF	ARG12TF□MF	ARG14TF□MF	ARG18TF□MF
POWER		220-240 V~50 Hz				
COOLING CAPACITY	[kW]	2.10-2.15	2.70-2.80	3.40-3.50	3.90-4.00	5.20-5.30
HEATING CAPACITY	[kW]	2.40-2.45	3.00-3.10	4.00-4.10	4.70-4.80	5.50-5.60
<b>DIMENSIONS &amp; WEIGHT</b>						
HEIGHT	[mm]	217				
WIDTH	[mm]	663		953		
DEPTH	[mm]	595				
WEIGHT	[kg]	18		25		

## DUCT TYPE (Low pressure)

MODEL		ARG25TF□MF	ARG30TF□MF	ARG36TF□MF	ARG45TF□MF
POWER		220-240 V~50 Hz			
COOLING CAPACITY	[kW]	6.95-7.05	8.60-8.80	10.3-10.5	12.4-12.7
HEATING CAPACITY	[kW]	7.60-7.85	8.80-9.10	10.5-10.7	13.4-13.7
<b>DIMENSIONS &amp; WEIGHT</b>					
HEIGHT	[mm]	270			
WIDTH	[mm]	1,210			
DEPTH	[mm]	700			
WEIGHT	[kg]	43		45	

# SPECIFICATIONS

## DUCT TYPE (High pressure)

MODEL		ARG36TF□MF	ARG45TF□MF	ARG60TF□MF
POWER		220-240 V~50 Hz		
COOLING CAPACITY	[kW]	10.3-10.5	12.4-12.7	16.4-17.0
HEATING CAPACITY	[kW]	10.5-10.7	13.4-13.7	17.0-17.6
<b>DIMENSIONS &amp; WEIGHT</b>				
	HEIGHT	[mm]	400	
	WIDTH	[mm]	1,250	
	DEPTH	[mm]	800	
	WEIGHT	[kg]	75	

## CASSETTE TYPE (Compact)

MODEL		AUG7TF□MF	AUG9TF□MF	AUG12TF□MF	AUG14TF□MF	AUG18TF□MF
POWER		220-240 V~50 Hz				
COOLING CAPACITY	[kW]	2.10-2.15	2.70-2.80	3.55-3.60	3.90-4.00	4.85-5.00
HEATING CAPACITY	[kW]	2.40-2.45	3.00-3.10	4.00-4.10	4.35-4.50	5.30-5.45
<b>DIMENSIONS &amp; WEIGHT</b>						
	HEIGHT	[mm]	235			
	WIDTH	[mm]	580			
	DEPTH	[mm]	580+70			
	WEIGHT	[kg]	18			

## CASSETTE TYPE

MODEL		AUG20TF□MF	AUG25TF□MF	AUG30TF□MF	AUG36TF□MF	AUG45TF□MF	AUG54TF□MF
POWER		220-240 V~50 Hz					
COOLING CAPACITY	[kW]	5.55-5.70	6.95-7.05	8.60-8.80	10.3-10.5	12.4-12.7	13.9-14.1
HEATING CAPACITY	[kW]	5.65-5.80	7.60-7.85	8.80-9.10	10.5-10.7	13.4-13.7	15.4-15.8
<b>DIMENSIONS &amp; WEIGHT</b>							
	HEIGHT	[mm]	296				
	WIDTH	[mm]	830				
	DEPTH	[mm]	830				
	WEIGHT	[kg]	38			40	

## WALL MOUNTED TYPE

MODEL		ASG14TF□MF	ASG20TF□MF	ASG24TF□MF	ASG30TF□MF
POWER		220-240 V~50 Hz			
COOLING CAPACITY	[kW]	3.90-4.00	5.55-5.70	6.70-6.80	7.80-8.00
HEATING CAPACITY	[kW]	4.70-4.80	5.65-5.80	7.60-7.70	8.55-8.80
<b>DIMENSIONS &amp; WEIGHT</b>					
	HEIGHT	[mm]	320		
	WIDTH	[mm]	1,250		
	DEPTH	[mm]	195		
	WEIGHT	[kg]	20		